

Rocket-Based Combined-Cycle (RBCC) Propulsion Technology Workshop Tutorial Session

*Proceedings of the tutorial session of a workshop
held at the University of Alabama
Huntsville, Alabama
March 23-27, 1992*

(NASA-CP-10090) ROCKET-BASED COMBINED-CYCLE
(RBCC) PROPULSION TECHNOLOGY WORKSHOP.
TUTORIAL SESSION (NASA) 259 p CSCL 21H

N92-21517
--THRU--
N92-21536
Unclass
0078344

93/20

NASA



NASA Conference Publication 10090

Rocket-Based Combined-Cycle (RBCC) Propulsion Technology Workshop Tutorial Session

*Proceedings of the tutorial session of a workshop
sponsored by NASA Headquarters, Washington, D.C.
and held at the University of Alabama
Huntsville, Alabama
March 23-27, 1992*

NASA

National Aeronautics and
Space Administration

Office of Management

Scientific and Technical
Information Program

1992

PRESENTATION SYNOPSES AND SHORT-PAPER VERSIONS OF THE WORKSHOP'S EXPERT PRESENTER "MINI-TUTORIALS"

A Message from the General Chairman

Tuesday, March 24th, the first Workshop full-day set of sessions is anticipated to be the key to success of the Workshop's productive deliberations and presented findings, activities which will round out the nearly full-week event. A genuinely unique set of presentations will be made at that time, bearing on the Workshop's subject: rocket-based combined-cycle propulsion technology and systems, applicable to future space missions.

On this day some two-dozen or so short "mini-tutorial" briefings will be provided by our Expert Presenters to the Workshop participants, covering four general topics:

- Selections from the Expansive Advanced Propulsion Archival Resource
- Related Propulsion Systems Technical Backgrounds
- RBCC Engine Multimode-Operations Related Subsystem Backgrounds
- Focused Review of Propulsion Aspects of Current Related Programs

The outstanding set of Expert Presenters your Workshop staff have been fortunate enough to have gathered together for this event, have generously agreed to provide these tutorial inputs both as oral presentations and (where they were able) as synopses and short papers as presented herein, drawing from their past and present professional experiences in active pursuit of their individual subjects (see the table of contents).

We hope that having these written versions of their presentations will both help to complement the oral presentations, and provide a permanent reference covering the technical information material. These records will, no doubt, be of interest to many of those were not able to directly participate with us in the Workshop itself.

Acknowledgments

We are indebted to the Workshop's distinguished cadre of Expert Presenters for their taking time, on very short notice, to prepare these synopsis/short-paper versions of their "mini-tutorial" oral presentations. We thank them for this extra effort.

The finalized printed versions of the presentations were prepared for distribution at the Workshop by a very dedicated team of individuals on the staff of NASA's Lewis Research Center in Cleveland, Ohio. Their publication effort, working closely with the authors was accomplished on very short notice, in a brief two-week period (and usually less!).

We acknowledge and thank Diane Billik, Anita Liang, Kristen Easton, Briceland Farrell, and Joyce Cieszewski, their colleagues and all the involved staff members at the Lewis Center for their important contribution.

William J.D. Escher
Workshop General Chairman

CONTENTS

Page

SESSION I - Selections from the Expansive Advanced Propulsion Archival Resource

<i>Early Aerospaceplane Propulsion Research</i> C.A. Lindley, Aerospace/Marquardt	1-1
<i>Early Air-Augmented Rocket, Ramjet, Scramjet Work</i> D. Van Wie, APL/JHU	2-1
<i>Pioneering Scramjet Developments by Antonio Ferri</i> J.I. Erdos and L.M. Nucci, General Applied Science Laboratories, Inc. (GASL)	3-1
<i>Advanced Ramjet Concepts Program</i> J.L. Leingang, Wright Research and Development Center	4-1
<i>The NASA Hypersonic Research Engine Program</i> K.F. Rubert, NASA Langley Research Center and HJ. Lopez, Allied-Signal Aerospace Company	5-1
<i>Hypersonic Airbreathing Propulsion/Airframe Integration</i> J.P. Weidner, NASA Langley Research Center	6-1

SESSION II - Related Propulsion System Technical Backgrounds

<i>Airbreathing Combined Cycle Engine Systems</i> J.L. Leingang for J. Rohde, NASA Lewis Research Center	7-1
<i>Air Augmented Conventional Rocket Engines</i> S. Farhangi, Rocketdyne Division, Rockwell International	8-1
<i>Brief Introduction</i> R. Rhodes, NASA Kennedy Space Center	9-1
<i>Liquid Air Cycle Engines</i> J. Rosevear, Marquardt	10-1

Cryogenic H₂-Induced Air Liquefaction Technologies for Combined-Cycle Propulsion Applications
W.J.D. Escher, NASA Headquarters 11-1

Supercharged Ejector Ramjet
J. Rosevear, Marquardt 12-1

RBCC Propulsion (Representative of Family Engines)
R. Foster, Astronautics Technology Center 13-1

SESSION III - RBCC Engine Multimode-Operation-Related Subsystem Backgrounds

Inlet Technology
P. Kutschenreuter, General Electric 14-1

H₂-Fueled High-Bypass Turbofan
J.C. Rippe, AiResearch Los Angeles Division 15-1

Annular Nozzle Engine Technology
A. Martinez, Rocketdyne Division, Rockwell International 16-1

Jet Compressor R & T (Air Augmented)
F. Herr (Consultant) 17-1

H₂-Fueled Flightweight Ramjet Construction & Test
A. Malek, Marquardt 18-1

Scramjet Analysis, Testing
J. L. Leingang for F. D. Stull, Wright Research and Development Center 19-1

Nozzle Characteristics for RBCC Hypersonic Systems
S. Halloran, Rocketdyne Division, Rockwell International 20-1

System Controls Challenges of Hypersonic Combined-Cycle Engine Powered Vehicles
R.H. Morrison and G.D. Ianculescu, Rocketdyne Division, Rockwell International 21-1

SESSION IV - Focused Review of Propulsion Aspects of Current Related Programs

NASP X-30 Propulsion Technology Status (Govt.)
W.E. Powell, NASP JPO (NASA) 22-1

NASP X-30 Propulsion Technology Status (Industry)
D. Kenison, NASP JPO (NASA) 23-1

NASA's Hypersonic Propulsion Program: History and Direction
S. Wander, NASA Headquarters 24-1

Beta II, A Near Term, Fully Reusable, Horizontal Takeoff & Landing Two-Stage-To-Orbit Launch Vehicle Concept
L.A. Burkardt, NASA Lewis Research Center 25-1

Advanced Manned Launch System (AMLS) Prop. Status
J. Olds, NASA Langley Research Center 26-1

International Aerospaceplane Efforts
C.A. Lindley, Aerospace/Marquardt 27-1

APPENDIX

RBCC Engines Applied to Extensive Axisymmetric Single Stage to Orbit Vehicles
R.W. Foster, Astronautics Corporation of America Technology Center 28-1

ORGANIZATIONS INVOLVED

<u>RESEARCH/CONCEPTS</u>	<u>ENGINE DEVELOPMENT</u>	<u>VEHICLE DESIGN TEAMS</u>
ASTRO/MARQUARDT	MARQUARDT	GENERAL DYNAMICS/SD
APL/JHU	PRATT & WHITNEY	LOCKHEED
GASL	(ROCKETDYNE, AIR- RESEARCH, ETC)	NORTH AMERICAN DOUGLAS MCDONALD BOEING REPUBLIC

TECHNOLOGY STATUS

IN HAND

MACH 2-3 RAMJETS, KEROSENE
LOX/RP ROCKETS; 300 sec
ALUM, STAINLESS, INCONEL, RENE
AIRFRAMES TO MACH4-5
ABLATION HEAT SHIELD R/V's

IN DEVELOPMENT

MACH 6-8 RAMJETS, H₂ REGEN
LH₂/LOX ROCKETS; 400 sec
TITANIUM, COATED MOLYBDENUM
LIFTING BODY AIRCRAFT,
RADIATION COOLED HEAT SHIELD

RELATED DEVELOPMENTS AT MARQUARDT

RAMJET-RELATED

ALL-SUPERSONIC COMBUSTION IN RAMJET
"HYPERJET" (ROCKET CONVERTABLE)
EXTERNAL SUPERSONIC COMBUSTION
ROTARY JET COMPRESSOR (& LACE)
LIQUID PROPELLANT RAMROCKETS
SOLID PROPELLANT RAMROCKETS

LACE-RELATED

BASIC LIQUID AIR CYCLE ENGINE
PINCH POINT; PARA-ORTHO; ICING PROBS
MULTIPLE FUEL ECONOMIZER CONCEPTS
HYBRIDS: RAMLACE, SCRAMLACE, NULACE;
TURBOROCKET LACE;
AIR STORAGE AND SEPARATION CONCEPTS
LIQUIFACTION / THRUST DEMONSTRATIONS
X-15 ENGINE DESIGN

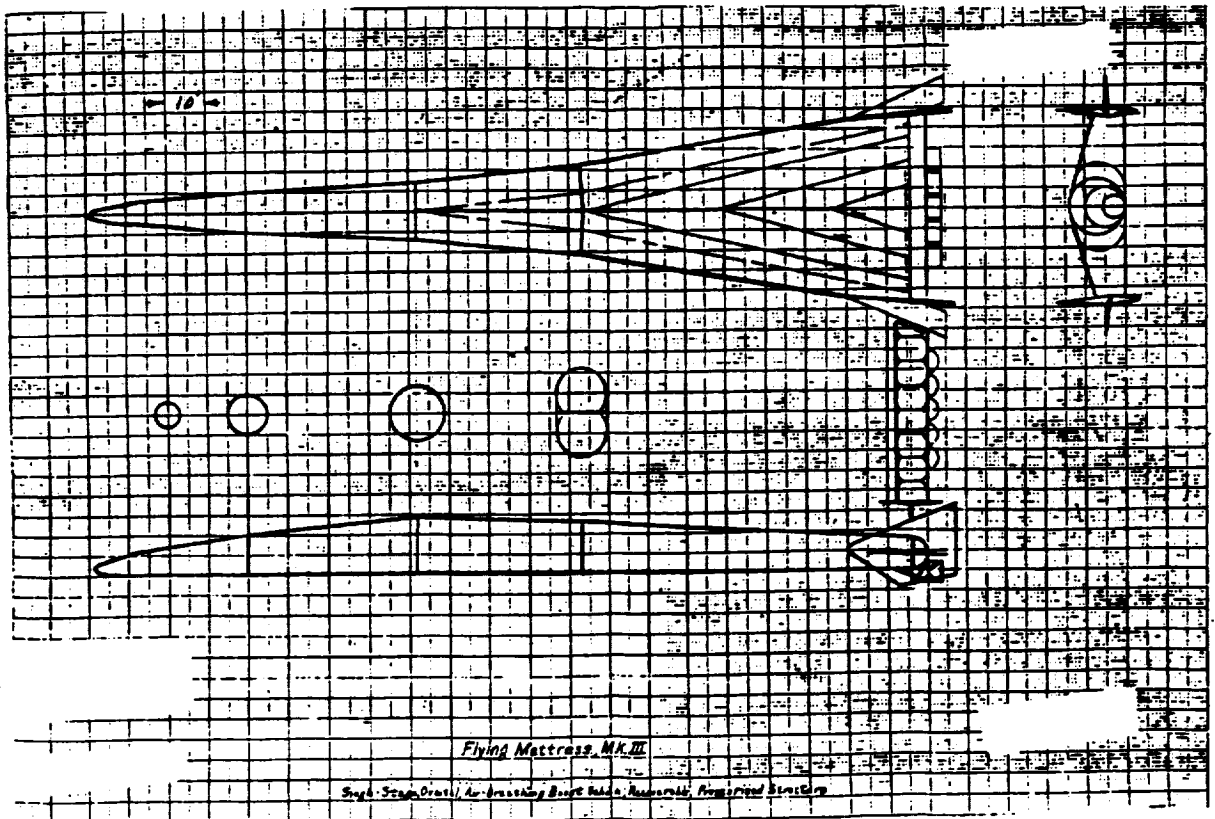

N 9 2 - 2 1 5 1 8

EARLY AEROSPACEPLANE PROPULSION RESEARCH;

MARQUARDT CORP; ca 1956-63

Dr Charles A. Lindley
18900 Pasadero Dr.
Tarzana, CA 91356

ABSTRACT

This is a brief summary of the very early days of Aerospaceplane propulsion and concept research, from a viewpoint based in the Astro Division of Marquardt Aircraft Company in the years listed, with some view into later times that were on Bill Escher's watch and other's. The following speakers will discuss other groups who were pursuing the same goals by various routes. Our chief purpose is to bring out background information that may be of value to members of this workshop and future workers in the field.

Many old reports have been amassed by Battelle, (Ref 1), but we notice that most of the earliest work in Marquardt Company Reports is omitted. (Some have since been supplied to Battelle, and are now in their files). Also several ICAS and AGARD proceedings which are not cited carried U.S. work to a world audience. And Swithenbank and others overseas also contributed to the field.

Organizations and People: There were three main groups (Figure 1) doing the engine research and conceptual work; Marquardt, APL/JHU, and GASL. Several companies were involved in engine development and production, and no less than seven major airframe companies were doing active design studies. There is not enough room here to even list the many people involved, but a few key players must be named. At APL there were Avery, Dugger, and Billig, who is with us today. At GASL, Tony Ferri, and SanLorenzo, who is here today. At Marquardt/ASTRO, some key people on our team were Carl Builder (my good right arm), Gene Perchonek, and Al Goldstein. There were also several staff specialists, such as Artur Mager, G.V. Roa, Paul Arthur, who assisted in such areas as hypersonic flow, external burning, heat transfer, equilibrium chemistry, etc. And Roy Marquardt himself, who knew how to draw together a team of rather wild horses and keep them aimed in useful directions.

Technology in Hand: The state of engine and airframe technology at those times must be understood to make sense of the effort (Figure 2). Operational kerosene fueled ramjets were routinely flying Mach 2-3 in the Bomarc and Talos interceptors. One Marquardt ramjet had accelerated a Lockheed X-7 test vehicle to about Mach 4.7 in an all-out test, holding it at nearly 1 "G" until the fuel ran out. But the recovered engine and airframe were badly overheated, and not re-flyable. Titanium skins,

carbon/carbon, and composites were not yet available. Engines used the heavier stainless steel, Inconel, and superalloys in high temperature parts. Ablation heat shields had been developed for Reentry Vehicles, but radiation cooling was still primitive.

Technology in Development: Prototype liquid hydrogen fueled ramjets with regenerative cooling were in development for Mach 6-8 operation. The inlet and exhaust nozzle area ratios of such engines were very high, and inlet starting and stability issues were not well understood. Internal heat transfer rates could exceed those of LH₂/LOX rockets, which were still under development. The total internal exposed area had to be minimized so that the total cooling load would not exceed the regenerative fuel cooling capacity. The resulting engine designs were unusual in appearance.

Ramjet Technology: Many related propulsion technology developments were under way at Marquardt and elsewhere (Figure 3). There were tests of many different ramjet fuels, including hydrogen, hydrocarbons, boron hydrides, pentaborane, tri-ethyl aluminum, tri-ethyl boron, boron and aluminum slurries, and powdered metals. There were tests of both liquid propellant ramrockets (with Rocketdyne), and solid propellant ramrockets (with Thiokol). A rocket-convertible ramjet engine called the "Hyperjet" was proposed for Aerospaceplane use. Tests and analyses were begun of a rotary jet-bladed compressor, as proposed by Foa, with either rocket or LACE as a jet source. Propulsion and maneuvering by external free-stream burning was also analyzed and tested.

LACE-Related technology: The Liquid Air Cycle Engine was invented at Marquardt in 1958, causing great excitement. It was first proposed to the Admiral Radford Committee by Marquardt and Boeing for first stages of expendable space boosters. But we soon realized that the engine raised the possibility of a single stage reusable space booster with airplane-type operation, as first reported in 1959 (Ref 2).

During the following three years, the LACE concept combined with the Aerospaceplane concept led to a proliferation of engine and engine system inventions in which most of our group and many from other companies were caught up. The basic low weight and high thrust of the LACE were remarkable. But the engine used 6 to 8 times more fuel than the engine could burn. First there was Carl Builder's basic scheme to economize on the fuel, followed by several variations on the theme. Next, various engines were hybridized to it to usefully burn the excess fuel. A few of these were the Ramlace, Scramlace, Superlace, Nuclear LACE, LACE turbo-rocket, and LACE-rocket. There were probably 50 to 100 variants examined.

The use of Slush hydrogen, a slurry of liquid and solid, was proposed to reduce the excess fuel use. It could be used or recycled to the tanks. Liquid air could be stored in low to medium Mach number flight, to be burned as oxidizer later, in rocket mode. The oxygen could be separated from the air, for storage without the nitrogen. Archie Gay and Bill Bond at General Dynamics /Convair seized upon this route very early in

the effort, and exploited it to the limit.

- Perhaps the most difficult problem we had was that in such a flurry of invention, it requires about a hundred times more manpower to do adequate design studies, weight analyses, performance analyses, and system trade-offs on each concept than it takes to invent it. Our efforts to manage this problem are discussed below.

Supersonic Combustion: Supersonic combustion in a detonation wave, with subsonic or transonic wave exit flow had been demonstrated in our labs and others. We felt that the resulting "shock" losses would be too great, and that for very high Mach number flight we must have combustion with supersonic exit flow, which we titled "Hypersonic Combustion", a name that never took. Our test people demonstrated the process. This reduced the estimated diffusion and combustion losses, so that analysis indicated we could exceed rocket propellant specific impulse to orbital speed and beyond.

This fed back immediately into our Aerospaceplane efforts, extending our sights beyond the Mach 6-10 maximum, to any speed that could be endured by the vehicle in the atmosphere.

Hardware and Testing: A large amount of experimental work was done to support these various proposals. Air liquefaction was demonstrated in 1960, using an Air Research heat exchanger, followed quickly by the addition of a rocket engine to burn the products. Supersonic combustion, of both internal and external burning types was demonstrated, using pebble bed heaters to attain full temperature simulation to about Mach 7+. Ramrocket mixing and combustion tests were run, using Rocketdyne rockets.

Scramjet for the X-15: A small Scramjet was designed and built for the X-15, starting in 1961. It was tested and flight ready about 1965. But a dummy engine was flight tested, and caused burn-off of part of the X-15 lower tail. Shortly after, the X-15 program ended.

Lace for the X-15: A detailed design also was made of a simple LACE engine for the X-15 vehicle. This machine would have had a thrust/weight ratio of about 25, and an I_{sp} of about 800 sec. By not crowding the state of the art, it could have bought us invaluable flight experience at a very modest price. Its was not built: one of our greatest regrets.

Computational Tools: Analyses of engine performance and weight, and system performance were the chief Achilles' heels of these efforts. It is easy to invent new engine and system concepts many times faster than they can be analyzed. Adequate analytical tools generally were not available. Where they were possible, the computer capacity was woefully inadequate. And each new Aerospace firm that entered the fray had to discover anew that their design and performance analysis tools were inadequate, and set about painfully upgrading. Marquardt kept ahead of the large and

growing industry effort with a remarkably small team.

Simplified Cycle Analysis: Computers were too slow to do full thermodynamic property computations for equilibrium combustion gas mixtures in cycle analyses. Some of the constants involved were still under dispute. Perfect gas-based analyses became useless above Mach 3 to 4. Air and combustion gas mixture Mollier diagrams were being painstakingly calculated and drawn by Carl Builder and others, but their use was tedious.

Starting in 1957 we developed simplified methods of cycle analysis that could bridge across the supersonic and hypersonic regimes successfully. This required a change of focus from temperature, Mach number, and delta T, as used in transonic and supersonic analysis to the right parameters for hypersonic propulsion, which are enthalpy, flight velocity, and heat of combustion. The change of focus greatly clarified our thinking on new engine concepts. The only publications of these methods are Ref 3, and the Appendix of Ref 4.

Boost Effective Specific Impulse: The forced wedding of aircraft and rocket trained personnel in Aerospaceplane design caused (and still causes) great confusion. The two groups define fuel efficiency as specific impulse versus specific fuel consumption. They deal with gravity and drag differently. And they differ in emphasis on cruise versus acceleration. In our efforts to rationalize these opposing viewpoints, we always expressed air-breathing performance as specific impulse, and then applied system and trajectory-based gravity and drag corrections in such a way that air-breathing performance could be integrated, albeit numerically, in the conventional rocket performance equations.

$$I_{\text{spett}}(V) = I_{\text{sp}}(V)[1 - D/T - (W \sin\beta)/T] \quad (1)$$

$$\ln(W_2/W_1) = -1/g \int dV / I_{\text{spett}}(V) \quad (2)$$

This formulation allowed rapid graphical or numerical analyses of system performance. It was spot-checked, of course, against the full trajectory analyses of various aircraft firms, and not only gave sufficiently accurate results, but often found flaws in the more complex programs. It also led to a natural presentation form on semi-Log paper that gives physical understanding of various system and engine comparisons and relationships.

Vehicle Concepts: Because of the intimate integration of engine and vehicle performance, we found it necessary to do our own preliminary vehicle designs. To answer critics who said the required weight fractions were impossible, in 1959 we proposed a "Flying Air Mattress" type of pressurized thin shell structure that gave hope of reaching the required weight. The 1960 version of the "Mattress" is shown in Figure 4a.

The very low thrust coefficient of the scramjet above Mach 10 led to much controversy over whether the engines could be sized large enough to drive the vehicle. Figure 4b was our attempt 1960 to illustrate how to turn the vehicle into a "flying engine" that we contended could continue to a Mach number of 20 or higher. Heating and material problems were admittedly severe.

These drawings and models were displayed in discussions with various airframe design groups. They had some effect on industry concepts. They were also used as "strawman" configurations for engine and system performance comparisons in various in-house studies.

Rules of Thumb: While history may be interesting, or at least amusing, to review, its real value is found when you find information relevant to the present and the future. I have looked over this material for the advice most relevant to the RBCC workshop. My choice is a couple of rules of thumb (Figure 5) that led to what I used to call "Lindley's Law", a statement of semi-despair.

Dozens of times, we or other teams in the chase, came up with a brilliant new engine concept or system concept, that promised to give us the payload margin to insure a successful single stage to orbit. Always, when we ran the total system weight and performance to ground, a year or more later, weight increases and performance losses required by the new concept ate up the profit, and we ended up at slightly less than zero payload. Out of this sad experience were born the following conclusions:

1. All new and better air-breathing SSTO concepts will have a better I_{sp} and therefore deliver more total weight to orbit.
2. After extensive analysis, a vehicle weight increase and performance losses will be found that exactly offset the weight gain.
3. The final result for every promising new propulsion or vehicle system therefore will be exactly the same, namely:

PAYLOAD TO ORBIT EQUALS EXACTLY -1% OF GLOW

With the improvements of modern materials and thermal protection systems, the baseline may have moved up to +1% or +2%. But the basic principle that bright new ideas get ground down to equality as reality enters the analysis is still with us!

In the first analysis of an improved concept, we tend to gloss over "small" things that come back to haunt us; weight of air-breathing inlets, their variation with Mach number, effects of air-breathing trajectories on TPS weight, scale effects on weight fraction, fuel density effects on weight fraction, etc. It usually takes a great deal of analysis to find the "second order" effects that can make or break a new concept. Don't get too enthusiastic too soon!

REFERENCES:

- 1. Anon., "High Mach Airbreathing Propulsion Technology Data Bank; Summary of Holdings by Key Performing Organizations", Battelle, Columbus Division.**
- 2. Lindley, C. A., "Preliminary Design Study of a One-Stage, Orbital, Recoverable Air-Breathing Booster", Report No. MR 20,057, ASTRO Division of Marquardt, July 23, 1959.**
- 3. Lindley, C. A., "Simplifications of Cycle Analysis", Report No. MR 20,097, ASTRO Division of Marquardt, June 1957.**
- 4. Lindley, C. A., "Performance of Air-Breathing and Rocket Engines for Hypervelocity Aircraft, Proceedings of the International Council of the Aeronautical Sciences, 4th Congress, Paris, 1964.**

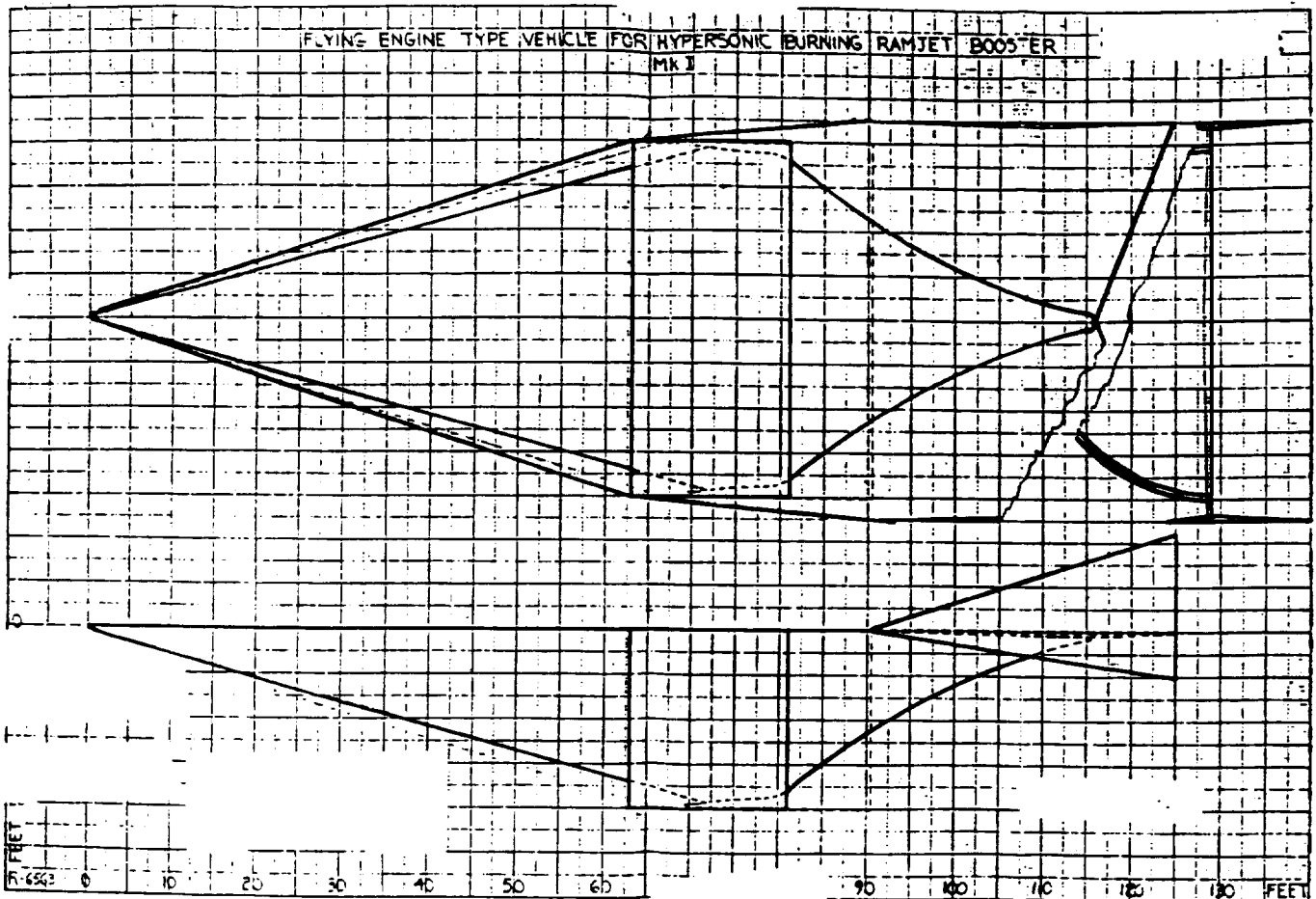

RULES OF THUMB

-COMPARED TO ROCKET POWER:

- ALL A/B TYPES WILL HAVE HIGHER I_{sp} OVER SOME SPEED RANGE
- A/B TYPES WILL DELIVER MORE WEIGHT TO ORBIT
- ALL A/B/TYPES WILL BE HEAVIER; THEREFORE:
- MOST OF THE EXTRA WEIGHT DELIVERED TO ORBIT WILL BE VEHICLE

LINDLEY'S LAW; 1962

-FOR ALL THE 'BEST' A/B ENGINE TYPES YOU CAN INVENT, THE ORBITAL PAYLOAD WILL BE THE SAME, NAMELY -1% OF GLOW!

- AMENDMENT, 1975: MAKE THAT 0%!
- AMENDMENT, 1990: MAKE THAT +1%!
- AMENDMENT, 1990: FOR ALTITUDE LAUNCH: MAKE THAT ~ +2%!!



EARLY AIR-AUGMENTED ROCKET, RAMJET, SCRAMJET WORK

**D. Van Wie
APL/JHU**

(Paper Not Received in Time for Printing)

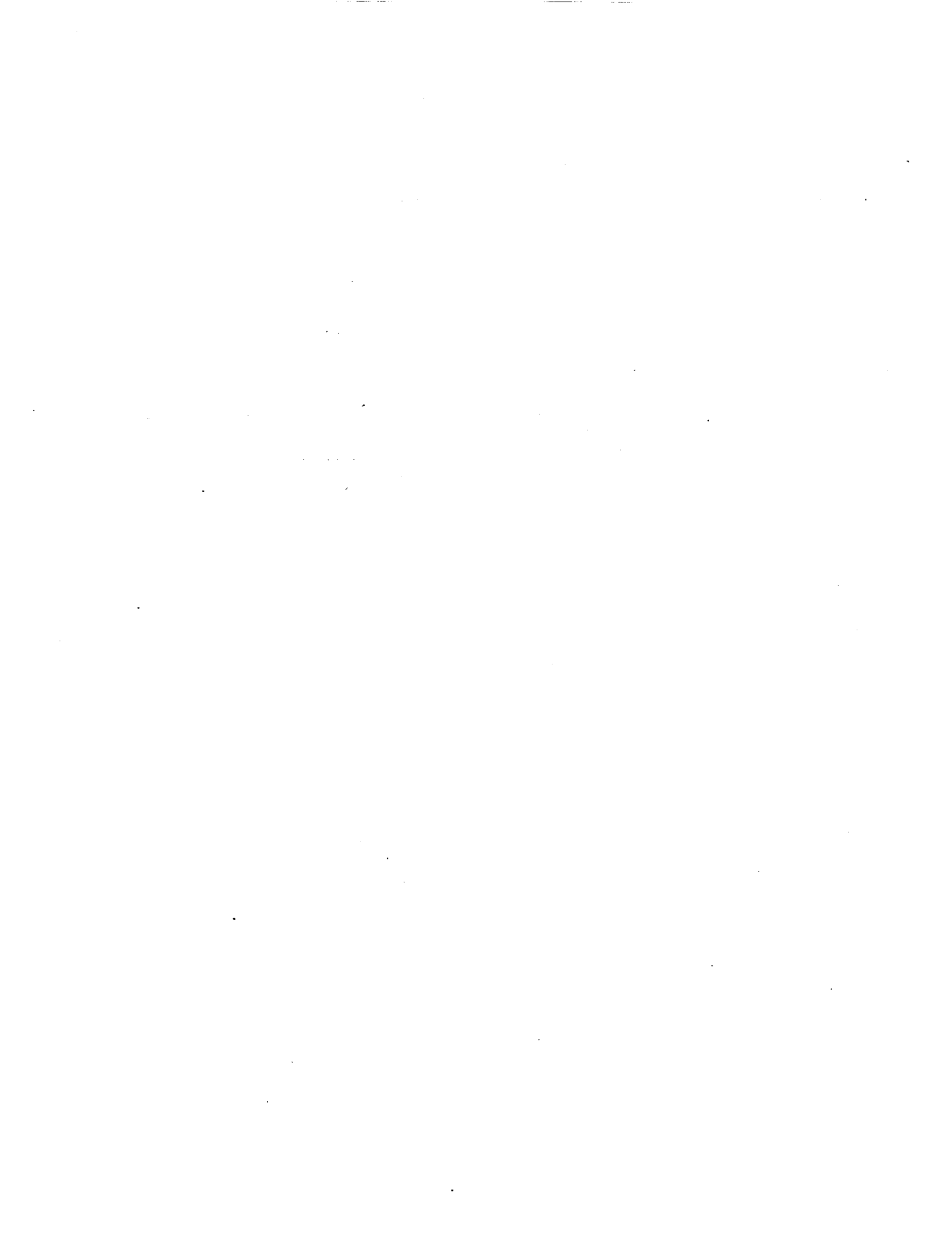

1992012277
628240
10p.

N92-21519

PIONEERING SCRAMJET DEVELOPMENTS BY ANTONIO FERRI

John I. Erdos and Louis M. Nucci
General Applied Science Laboratories, Inc. (GASL)
Ronkonkoma, New York 11779

PROLOGUE

"I would like to make the following statement: The existing technological ability and scientific background accumulated in many years of work will be lost if a small but continuing effort in this field is not maintained. Resumption of work in air-breathing engines at a later date would require a much larger effort."

Antonio Ferri, 1960, "Possible Directions of Future Research in Air-Breathing Engines," AGARD Combustion and Propulsion Colloquium, Pergamon Press Ltd., London, England.

"We now have 5000 people working on the National Aero-Space Plane program"

Robert Barthelemy, 1990, address to participants in the 8th Semi-annual NASP Technology Symposium, Monterey, California.

INTRODUCTION

This presentation summarizes the concept of a diffusive burning supersonic combustion ramjet engine (scramjet) envisioned by Antonio Ferri and highlights some of the salient technologies developed at GASL, PIBAL and NYU under his direction.

Although true paternity of the scramjet engine may never be conclusively determined, it is clear from the published literature that the concept of a ramjet engine that burned the fuel in an airstream which entered the combustor supersonically occurred more-or-less independently to a small group of researchers between 1947 (References 1 and 2) and 1960 (References 3 and 4). Two approaches were envisioned: one used a detonation wave to burn the fuel and the other, first proposed by Ferri, used a diffusive (i.e. mixing controlled) process that was (ideally) shock-free. The subsonic burning ramjet, the supersonic detonative-burning scramjet and the diffusive-burning scramjet are compared schematically in Figure 1. The detonation wave engine concept is clearly first attributable to Maurice Roy (Reference 1) but the recorded discussion following his 1959 paper indicates that the first

experimental demonstrations were carried out in U.S. industrial and university research labs in the late 1950's, and that Ferri's experimental achievement of diffusive supersonic combustion carried out at the same time, also in the U.S., was, at very least, the first such demonstration having development of an orbit-capable aircraft engine as its goal (Reference 5). Inclusion of the diffusive-burning supersonic combustion ramjet in a "composite" (i.e. multi-stage) system was also envisioned from inception of the engine concept (Reference 6).

Ferri conducted most of his basic scramjet research activities in the Aerospace Laboratories he built at the Polytechnic Institute of Brooklyn (PIBAL) and later at New York University (NYU), and directed the technology development, systems development and application studies employing the resulting technology to supersonic and hypersonic cruise and orbit-capable aircraft at General Applied Science Laboratories, Inc. (GASL). The first serious attempt to design and build a SSTO aircraft employing a composite turbojet, ramjet, scramjet and rocket system was conducted in cooperation with Republic Aviation, as part of the Air Force's original Aero-Space Plane project. As described in the Republic Aviation News issue of September 9, 1960, the aircraft would employ four hydrogen-fuelled J-58 type turbojet engines and four ramjet engines that transitioned to supersonic combustion for the Mach 7 to 25 range, have a gross take-off weight of 400,000 lbs and a payload of 20,000 lb. The Air Force program was terminated about five years later, and while none of the competing aircraft designs could achieve the SSTO objective, it is generally agreed that the Republic design with its heavy dependence on airbreathing propulsion to orbit was the most promising. Concurrently with the Aero-Space Plane program, the Air Force sponsored several scramjet engine development programs. An Air Force press release dated November 12, 1964, announced the "first successful demonstration of internal thrust from a scramjet engine." "The tests were conducted at General Applied Science Laboratories, Inc. Westbury, New York, under the supervision of Dr. Antonio Ferri, GASL President."

TECHNICAL HIGHLIGHTS

"From an operational point of view, the ideal vehicle for space investigations is probably a vehicle that is able to take off as an airplane with low accelerations, can accelerate gradually to orbital speed along a trajectory that can be controlled in time and position, can carry a large payload, and can re-enter, land, and be used again for successive missions." With those introductory remarks, Ferri went on to describe a preliminary study of such an orbit-capable aircraft in Reference 3. He proposed use of hydrogen-burning turbojet engines to accelerate from take-off to Mach 3, followed by ramjet engines to "high Mach numbers" (around 8 to 10) and then diffusive burning scramjets to orbit. He dismissed use of detonative combustion due to the variable geometry requirements. Indeed, he recognized that the specific impulse (Isp) advantage of the ramjet/scramjet could be easily offset by the weight of a variable geometry inlet system. The desire to achieve the required inlet starting characteristics at low supersonic Mach numbers and the required compression at high Mach numbers with a fixed geometry engine became the hallmark of Ferri's scramjet work. Toward this end, his inlet designs became characteristically three-

dimensional and employed the concept of "thermal compression" to achieve the goal of fixed geometry.

Without regard to the details of the design, the first paper presented a series of scramjet engine parameters and performance characteristics that varied relatively little in subsequent studies. What did change is the depth of the technology base and design effort to support the performance estimates. The original vehicle layout is shown in Figure 2, together with the weight and payload. Ferri noted that a doubling of structural weight would triple the take-off weight, perhaps more closely resembling the Republic design. The key engine design parameter is the combustor inlet Mach number, which is shown in Figure 3. Further details of the inlet and combustor were presented in later papers. The initial estimates of specific impulse in the scramjet mode from this study are presented in Figure 4. Ferri's aircraft design also placed more emphasis on maximizing the inlet capture area than the Republic design. The figure of 100 sq.ft. of inlet stream tube capture area pertains to Figure 5, which shows the engine thrust levels. Estimates of thrust minus drag then yielded the acceleration potential shown in Figure 6.

A concerted effort to provide the technology base for these performance estimates then followed at PIBAL (Reference 7). Notable accomplishments included the development of pioneering CFD capabilities based on the Method of Characteristics and Parabolized Thin-Layer Navier Stokes solvers with coupled finite-rate chemical reactions, experimental surveys of supersonic hydrogen-air mixing layers and comparisons with theory to "tune" the postulated eddy viscosity models, and conduct of diffusive supersonic combustion experiments with direct and schlieren flow visualization.

In a coordinated effort at GASL, Ferri directed the construction of a combustion-driven shock tunnel in which the first measurements of supersonic combustion of hydrogen in a pulse type test facility were made. These measurements became the basis for the first correlation of ignition delay time for hydrogen-air mixtures at representative scramjet conditions. He also built a hydrogen combustion heated vitiated air wind tunnel with Mach 3 to 8 simulation capabilities to test ramjet and scramjet engine concepts, which is still in daily use.

The results of these technology development studies as well as updated system studies were summarized in Ferri's 1964 Lanchester Memorial Lecture (Reference 8) and in an AIAA survey article (Reference 9). Of interest is the capture area schedule and total pressure recovery calculated for a fixed geometry inlet in the Mach 4 to 24 range shown in Figure 7. The inlet design is "similar to that" of Reference 3. Spillage drag and skin friction drag were included in the calculated performance shown in Figure 8. It was also pointed out in this paper that a fairly low trajectory must be flown to have sufficient air capture rate and dynamic pressure to be able to obtain an adequate thrust margin for acceleration, indicated in Figure 9 as the "acceleration corridor." Associated with the high dynamic pressure is a high heat transfer rate and consequently a high temperature (2000°R) for the hydrogen fuel being used as a regenerative coolant for the structure. On the positive side,

a significant amount of thrust is derived from expanding the hot hydrogen to supersonic axial velocity through the fuel injectors. On the other hand, at some suborbital speed (depending on the trajectory and the vehicle design) the fuel flow rate required to cool the structure begins to exceed the stoichiometric rate required for acceleration. In Ferri's design, this occurred at about Mach 22, as shown in Figure 10, with the inlet and nozzle surfaces being the primary contributors to the cooling problem. Performance trade-offs associated with fuel-air equivalence ratio and other engine component parameters are discussed in the paper. Although the quantitative results for engine performance may not be consistent with current technology, all the basic aerophysics and engine design considerations discussed in this paper are still pertinent today.

While not explicitly covered in this presentation, the subject of thermal compression is well worth noting. The basic concept was to use the addition of fuel mass and the concomitant release of heat to accomplish a portion of the inlet compression process, in preference to variable inlet contraction. The fluidic control system should be substantially lighter than mechanical systems for geometric variations of the inlet surfaces. The concept was originally tested at relatively low supersonic Mach numbers where the low momentum of the fuel and large pressure increases associated with combustion conspired to make control difficult. However, at the higher (hypersonic) Mach numbers where scramjet combustor tests are currently being conducted in pulse facilities, the occurrence of thermal compression is frequently evident in the data, and the conditions are far more favorable to its exploitation.

EPILOGUE

Ferri's last review of scramjet technology was presented at the AIAA Third Annual Meeting in 1966 (Reference 10). He left GASL in 1967, and in 1968 moved from PIB to NYU. He continued his research efforts in scramjet combustion at NYU under NASA sponsorship. In 1972, Ferri and a group of colleagues rejoined GASL. Unfortunately, he died of a heart attack in 1975, about a decade before the current resurgence of interest in scramjet engines and SSTO aircraft began. His close colleague, Mr. Ernest Sanlorenzo, who joined Ferri (and the second author) at GASL in 1956, devoted a large part of his career to pursuing scramjet technology, and was originally scheduled to give this presentation, also died of a heart attack in January 1992, while managing the NASP ramjet/scramjet tests at GASL. The remaining "corporate memory" of Ferri's ideas for the design of scramjet engines, not reported in the literature but conveyed through lively technical discussions, resides with three people at GASL (besides the authors) and a few people scattered throughout the aerospace community.

REFERENCES

- (1) Roy, M., "Thermodynamique des Systemees Propulsifs a Reaction," DUNOD, Paris, France, 1947.

- (2) Roy, M., "Propulsion Supersonique par Turboreacteurs et par Statoracteurs," Proc. First International Congress of the Aeronautical Sciences (ICAS), Madrid, Spain, 8-13 September 1958.
- (3) Ferri, A. "Possible Directions of Future Research in Air-Breathing Engines," Fourth AGARD Combustion and Propulsion Colloquium, Pergamon Press Ltd, London, England, pp. 16-36, 1960.
- (4) Dugger, G. L., "Comparisons of Hypersonic Ramjet Engines with Subsonic and Supersonic Combustion," Ibid, pp. 84-119.
- (5) Ferri, A., Daskin, W., Feldman, L. and Nucci, L., "The Launching of Space Vehicles by Air-Breathing Lifting Stages," in Vistas in Astronautics, Vol II, Pergamon Press Ltd, London, England, 1959.
- (6) Nucci, L.M., and Zipkin, M. A., "Composite Air-Breathing Systems," Ibid, pp. 16-36.
- (7) Ferri, A., Libby, P. A., and Zakkay, V., "Theoretical and Experimental Investigation of Supersonic Combustion," Proc. Third ICAS, Stockholm, Sweden, 27-31 August 1962. Also available as PIBAL Report 713, AD 291-712, September 1962.
- (8) Ferri, A., "Review of Problems in Application of Supersonic Combustion," Journal of the Royal Aeronautical Society, Vol 68, No.645, September 1964.
- (9) Ferri, A., "Supersonic Combustion Progress," Astronautics and Aerospace Engineering, August 1964.
- (10) Ferri, A., "Review of Scramjet Propulsion Technology," AIAA Paper No. 66-826, 29 November - 2 December, 1966.

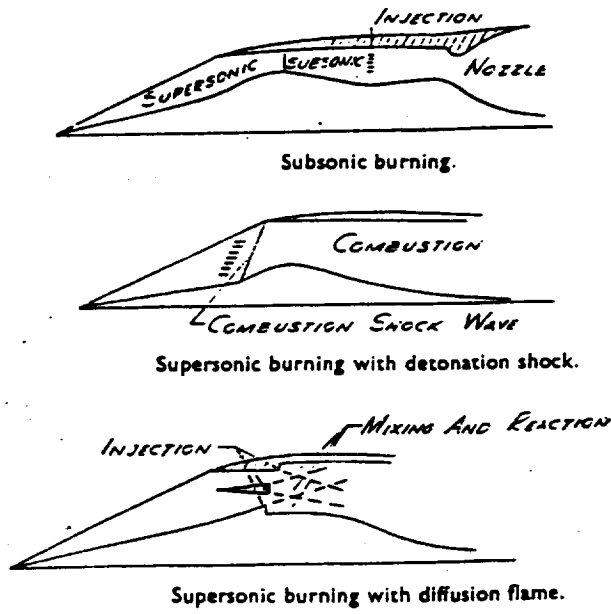

Figure 1. Schematic Representations of Subsonic Burning Ramjet, Detonative Burning Scramjet and Diffusive Burning Scramjet

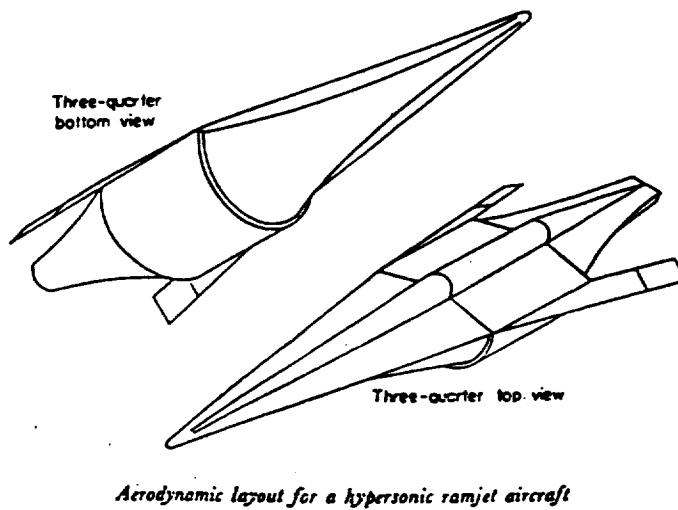
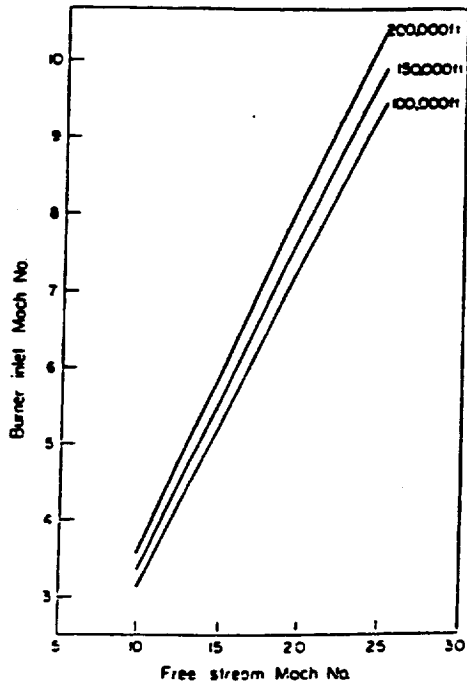

Table 1

Initial weight	130,000 lb
Empty weight in orbit	50,000 lb
Payload in orbit	10,000 lb

Figure 2. Perspective Drawings of Ferri's 1960 Air-Breathing SSTO Aircraft and Estimated Weights



Ramjet burner inlet Mach number

Figure 3. Scramjet Combustor Entrance Mach Number Schedule (1960)

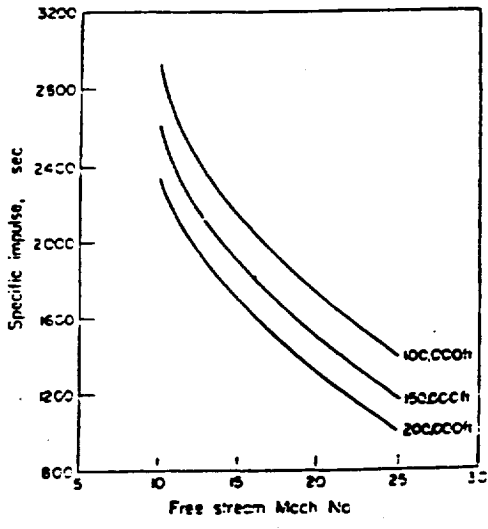

Ramjet specific impulse with supersonic burning hydrogen fuel

Figure 4. H₂-fuelled Scramjet Specific Impulse Estimates (1960)

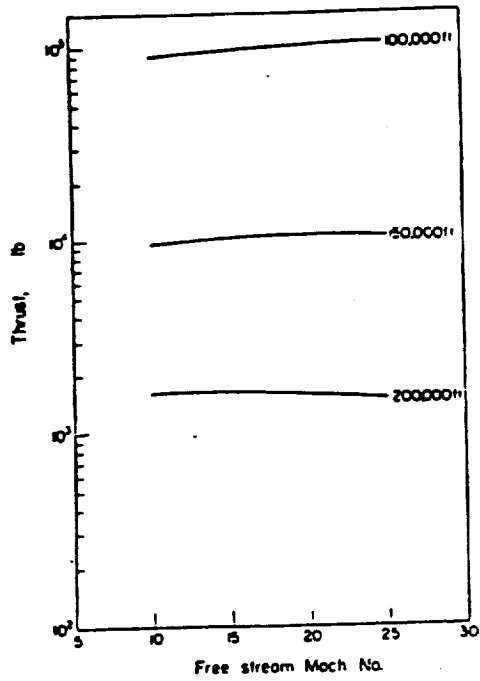

Ramjet thrust with supersonic burning; free stream capture area 100 ft²; hydrogen fuel

Figure 5. H₂-fuelled Scramjet Thrust Estimates (1960)

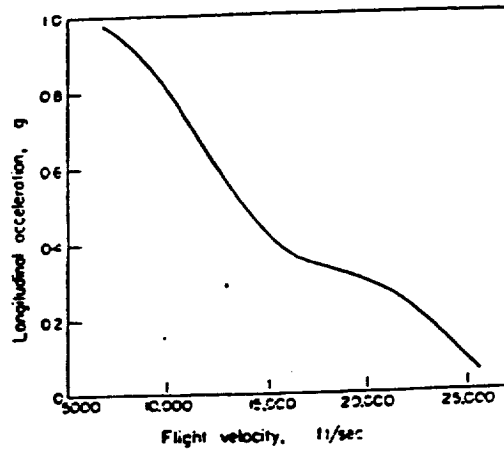

Typical acceleration capability for a hypersonic ramjet aircraft

Figure 6. Acceleration Capability of Ferri's 1960 SSTO Aircraft

**INITIAL CONDITIONS FOR
FIXED-GEOMETRY ENGINE**

A_1/A_0' (burner entrance inlet areas) = 0.02.

A. Inlet performance.

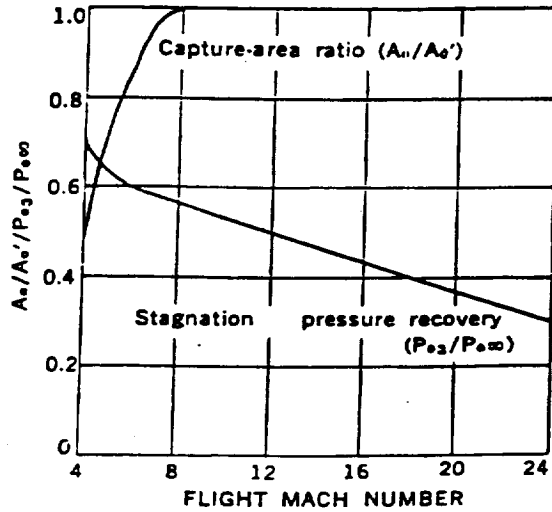

Figure 7. Performance of Ferri's Fixed Geometry Inlet (1964)

ENGINE PERFORMANCE FOR FIXED-GEOMETRY ENGINE

A_1/A_0' (burner entrance area/inlet area) = 0.02;

nozzle exit area/inlet area = 1.2; P_∞ = free-stream pressure.

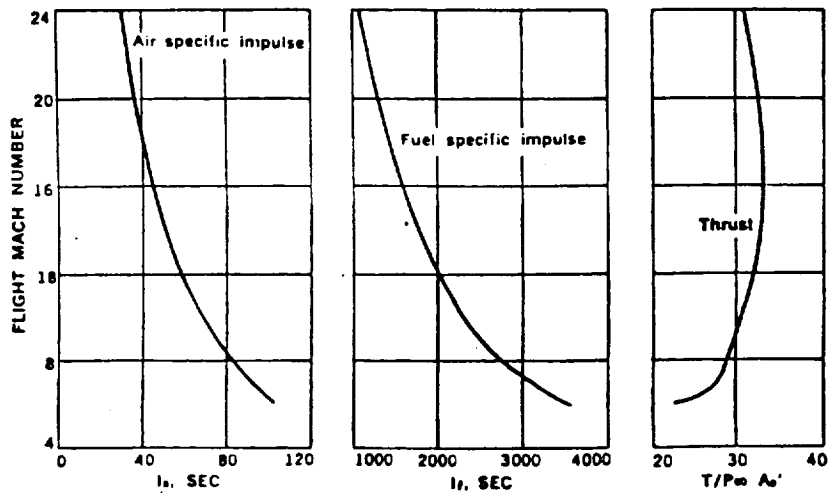

Figure 8. Performance of Ferri's Fixed Geometry Scramjet Engine (1964)

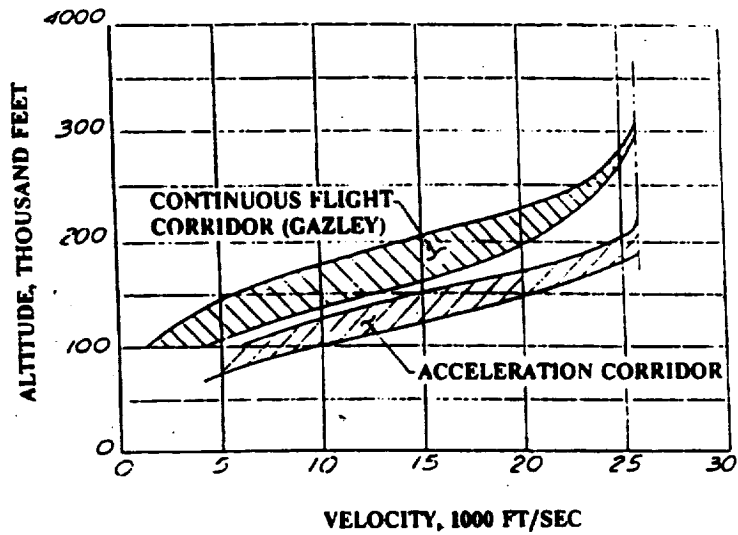

Figure 9. Comparison of Ferri's "Acceleration Corridor" with Gazley's "Continuous Flight Corridor"

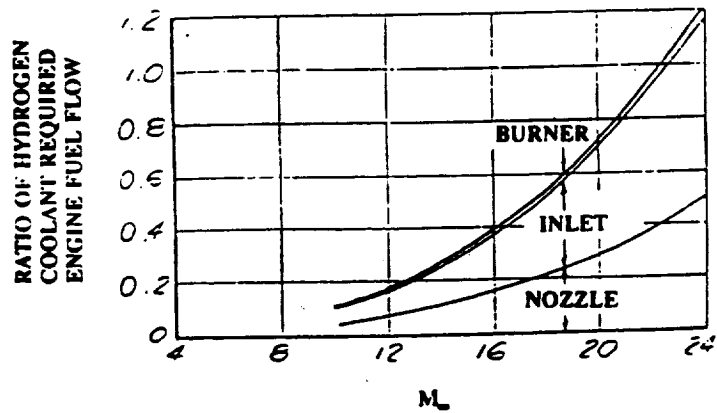

Figure 10. Cooling Requirements for H₂-fuelled Scramjet Powered SSTO Aircraft (1964)

1992012278
628249
N92-21520
10p.

ADVANCED RAMJET CONCEPTS PROGRAM

**J. L. Leingang
Wright Research and Development Center
Wright Patterson AFB, OH**

Uniquely advantageous features, on both the performance and weight sides of the ledger, can be achieved through synergistic design integration of airbreathing and rocket technologies in the development of advanced orbital space transport propulsion systems of the combined cycle type. In the context of well understood advanced airbreathing and liquid rocket propulsion principles and practices, this precept of synergism is advanced mainly through six rather specific examples. These range from the detailed component level to the overall vehicle system level as follows:

- Utilizing jet compression, as a specific air-augmented rocket mode approach
- Achieving a high area-ratio rocket nozzle through innovative use of air-handling ducting
- Ameliorating gas-generator cycle rocket system deficiencies while meeting, (1) ejector mode afterburner and, (2) rocket-mode internal aerodynamic nozzle operating needs
- Using the in-duct special rocket thrust chamber assembly as the principal scramjet fuel injection station
- Using the unstowed, covered fan as a duct closure for effecting high area-ratio rocket-mode operation
- Creating a unique airbreathing rocket system via the onboard, cryogenic hydrogen-induced air liquefaction process.

ILLUSTRATIVE CASES-IN-POINT: AIRBREATHING/ROCKET SYNERGISM

JET COMPRESSION

Jet compressors resemble conventional ejectors as used in industrial applications of yesterday (steam-locomotive smokestacks), and today (steam-cycle electric powerplant vacuum condensers). A propulsion-oriented application familiar to rocket test personnel are steam ejector systems used to initially "pull down" and/or actively exhaust a rocket altitude-simulation facility (e.g., as used in RL-10 engine testing).

In the combined cycle engine context, jet compressors are made up of a supersonic primary flow unit installed in a duct with an inlet providing the secondary flow to be compressed (air in this case). The downstream portion of the duct is divided into a mixer (usually of constant area),

followed by a diffuser having diverging geometry for diffusing the mixed high-subsonic flow. Compression is achieved in the mixed stream by virtue of the high "driving" enthalpy of the primary flowstream, in this case a rocket.

Such jet compressors are characterized as "effective," if not necessarily "efficient" compressors, having characteristic advantages and disadvantages. They are lightweight, rugged, and highly tolerant of flow-distortion profiles, on the one hand. On the other, in contrast to conventional turbomachines, they have relatively high propellant consumption rates, and require considerable mixing duct lengths, hardware which usually must be actively cooled.

AIRBREATHING-MODE DUCTING USED AS HIGH AREA-RATIO ROCKET NOZZLE

The obvious technical approach is to utilize part of the air-handling duct and the airbreathing mode(s) combustor/nozzle assemblies to this end. Although this approach remains yet undemonstrated in "the problem has been solved" sense, there is analytical and even experimental evidence that this is, indeed, a feasible design approach. This evidence will be summarized below.

Specifically, the objective is to so configure and operate the engine (in rocket mode) as to provide an "aerodynamic or virtual" nozzle extension for the physical rocket unit with its low expansion-ratio nozzle. This aerodynamic extension would "control" the underexpanded supersonic exhaust plume such that it would smoothly attach to the engine's specially configured airhandling duct now serving as a physical nozzle extension. The objective is to minimize shock losses and otherwise non-optimum intermediate exhaust expansion processes.

Once attached, the divergent final section of the duct would continue the nozzle expansion process to very high area ratios of, say, several hundreds-to-one. The following flow exiting from the engine duct, or nozzle, further expansion of the rocket exhaust would take place on the vehicle aft-body. Nozzle aerodynamics-wise, the mechanization of this latter approach is seen to be a fortunate carry-over from the supersonic combustion ramjet mode (where aft-body expansion is a virtual necessity), assuming that the scramjet mode is to be used.

ADVANTAGEOUS DISPOSITION OF ROCKET SUBSYSTEM TURBOPUMP GAS GENERATOR EXHAUST

CONVENTIONAL LIMITATIONS OF GAS-GENERATOR TYPE ROCKET ENGINES

Historically, hydrogen/oxygen rocket engines have utilized turbopump propellant feed delivery systems. This achieves high combustion pressures leading to advantageous high area-ratio nozzle operation, without the structural weight penalties which might accompany pressure-fed systems, which are inherently difficult to execute with liquid hydrogen fuel.

Various turbopump drive approaches have been selected in hydrogen-oxygen rocket engines developed to date. For U.S. engines developed so far, the following turbopump drive approaches have been used:

RL-10
J-2
SSME

Expander Cycle
Gas Generator Cycle
Staged Combustion (Topping) Cycle

Looking ahead, it would seem to be the case that the staged combustion system will continue to be favored for large rocket engines, e.g., possible successors to the SSME (which pioneered this turbopump drive cycle). For smaller engines, such as those which might be applied to orbital transfer vehicle (OTV) systems, the expander cycle appears to be favored. Why not the gas generator cycle for these applications? The answer is, its lower special impulse performance, as next discusses.

Although the gas generator cycle has a number of technical advantages (e.g., low pump-out pressures, achievement of high engine thrust/weight ratios, reduced interfacing difficulties), it has one salient and intrinsic disadvantage: a low-pressure fuel-rich turbopump turbine exhaust, which is not very effective in producing additive thrust. This leads to an overall engine specific impulse deficiency in comparison with the competing turbopump-drive approaches.

GAS-GENERATOR CYCLE IN THE COMBINED CYCLE ENGINE

In addition to its advantages in the conventional rocket engine context, which should carry over into a combined cycle system, the gas generator cycle may actually be strongly preferred in selecting the design of the engine's rocket subsystem. The main reason lies in unique uses of the turbopump-drive fuel-rich exhaust flow. A secondary reason for this preference lies in what is probably a poor physical design integration prospect for both the staged-combustion, and expander cycle alternative.

ROCKET MODE

Taking the second-name mode first, it has been previously treated as the probable need for a finite secondary flow (Rocketdyne's "basebleed") to maximize "aerobell" nozzle performance. The turbopump exhaust of the gas generator cycle seems to be a natural source of the base-bleed flow. In fact, the secondary flow might well have to be otherwise created in the case of the staged combustion cycle, for instance. Whether the gas generator exhaust flow "naturally matches up" with the special aerobell configuration needs in its quantity available, or in its flow properties, has yet to be examined. Perhaps some system optimization effects will be devised to steer the turbopump component design in one direction, or another. But the point remains that there is what appears to be a good "fit" for the gas generator cycle (and not the other alternatives) in mechanizing the combined cycle rocket mode. After all, this is the implied expectation supported by the effort reported by the Rocketdyne researchers.

EJECTOR MODE

Proceeding now to the first of the two rocket-operating modes, the ejector mode, some discussion of the thermodynamic process nature of this operation is called for. This has to do with the specific type of air-augmented rocket to be selected, as covered in the earlier discussion of the jet compressor process.

Alternative concepts proposed for accomplishing air augmentation of rockets, presumably to raise specific impulse and/or thrust levels, are several. They range from affixing a simple, lightweight fixed-geometry duct or shroud around an otherwise conventional rocket engine, to more complex, but are judged to be more workable systems. Unfortunately, space here does not permit even a summary review of the possibilities. Alternatively, let us go to one leading-candidate type system as evidenced in previous assessments the afterburning cycle air augmented rocket.

DIFFUSION AND AFTERBURNING CYCLE AIR AUGMENTED ROCKET

The stipulation of a stoichiometric rocket (departure from the usually fuel-rich setting) now joins the earlier specification of an unconventional "distributed" high shear-area configuration, as a design precept, or hardware determinant. This is, of course predicated on the selection of the DAB cycle.

Now the afterburning aspect of this cycle implies making fuel available in the afterburner combustor, downstream of the ejector's mixer and diffuser. Typical engine designs provide for conventional afterburner (or ramburner) fuel supply and injection means. Here is how the gas generator cycle again appears to fit in well. Recall its performance detriment, as a rocket, stemmed from its characteristic fuel-rich (to control turbine temperatures) low pressure (turbine-drive enthalpy extraction) exhaust.

This gas can now be very usefully combusted in the (relatively) low-pressure afterburner. Calculations check that, even with this hot gaseous fuel supply, substantial amounts of additional fuel--hydrogen in this illustration--are required to burn stoichiometrically with air, for full-engine-power conditions, as needed for high-thrust acceleration propulsion operation. Hence, the gas generator cycle's turbine exhaust "detriment" is largely removed and, as we have seen, the gas generator cycle becomes uniquely and naturally the system of choice in the type of combine cycle engine under discussion.

IN-DUCT SPECIAL CONFIGURATION ROCKET THRUST CHAMBER ASSEMBLY FOR SCRAMJET FUEL INJECTION

A specialized "rocket engine subsystem" was designed by Rocketdyne for the 1966-1967 "Composite Engine Study". The special combined cycle engine for which this subsystem was designed was a circular cross-section version of what is referred to as the ScramLACE engine. It turns out that the final version of this engine had a rectangular cross-section duct configuration to more optimally match up with the Lockheed-designed first-stage vehicle of the study. The 2-ring configuration was, in the final version of this engine accordingly replaced with eleven vertically-mounted "linear" thrust chambers of equivalent propellant flow-rate and thrust. These hydrogen-fueled units used liquid air (LAIR) as oxidizer.

TRUE AIRBREATHING ROCKET SYSTEMS VIA AIR LIQUEFACTION

Onboard cryogenic hydrogen-induced air liquefaction was fairly heavily dealt with in the original aerospaceplane R&D of the 1960s in both analysis and design experimental set-ups. Some of the design consequences of this refrigerative capacity limitation are gone into below. As the available airbreathing achieves testify, a number of air liquefaction cycles were vigorously explored in the early 1960s, ranging from "BasicLACE through SuperLACE" to "ACES (Air Collection and Enrichment System)."

These earlier developments were substantially more extensive than today's propulsion engineers seem to be aware, not just in terms of dollars and manhours expended, but in depth and sophistication of the design analyses conducted, and the experiments which were run. All in all, there was considerable success in the early developmental experiments conducted.

By the late 1960s, when there was a cessation of further research and development work in air liquefaction systems and subsystems, a substantial level of technology had been documented. Particularly important, some of the salient design and operating challenges became fairly well-known, and design solutions accordingly brought forward.

One of the salient objectives of liquefying air in such systems was to provide a means for operating very lightweight, compact engines, which could gain the "airbreathing advantage" while maintaining rocket-like qualities of low weight and compactness. Such was achievable in principle and technically illustrated in small-scale test rigs encompassing: (1) a liquid air pump of the rocket engine type, and (2) a high-pressure rocket-type thrust chamber. These equipment items were much more compact and less massive than the corresponding conventional ambient-temperature air compressor and its drive turbine and, lower combustion pressure turbojet-type combustor or afterburner assemblies.

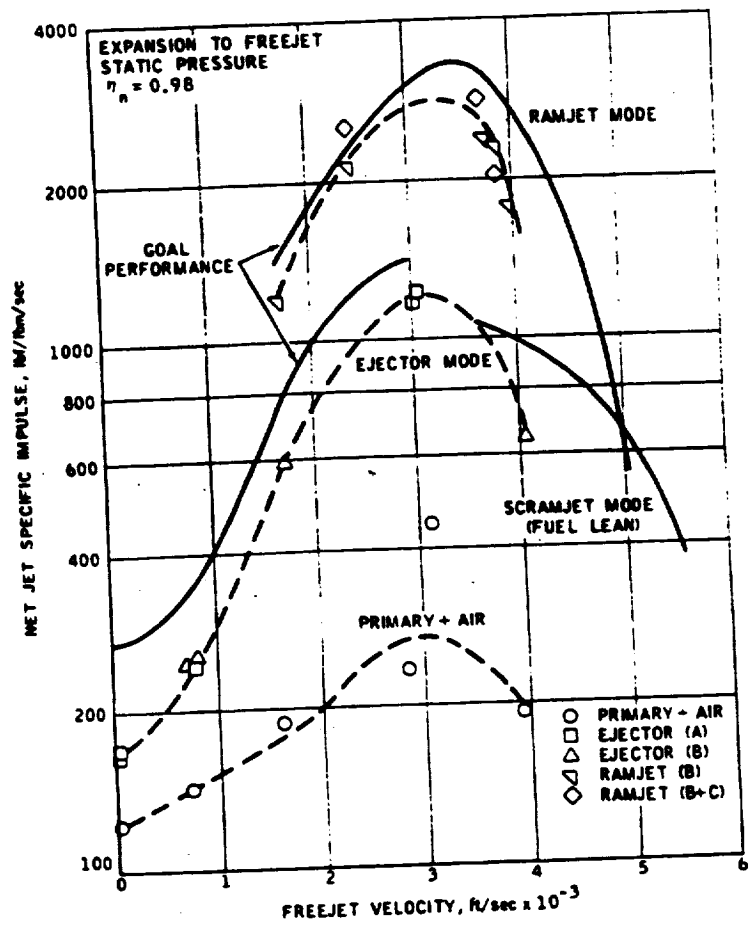

EJECTOR SCRAMJET TEST ENGINE PERFORMANCE

FIXED GEOMETRY

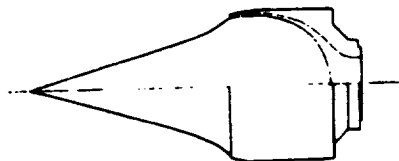

(a) FIXED GEOMETRY, LC CONTRACTION RATIO, ALL-EXTERNAL COMPRESSION

VARIABLE GEOMETRY

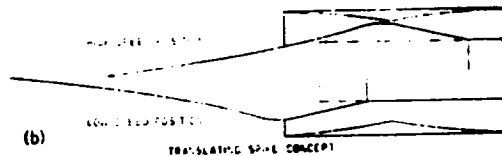

(b) TRANSLATIC SPINE CONCEPT

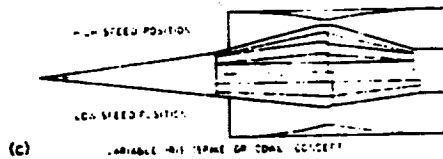

(c) VARIABLE RATE OF CONE CONCEPT

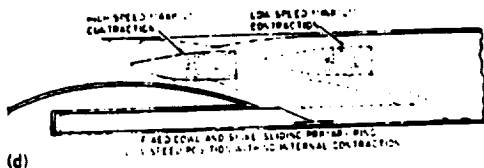

(d)

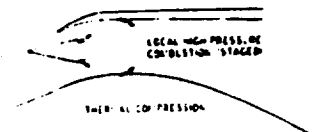

(e)

SPECTRUM OF POTENTIAL EJECTOR SCRAMJET INLET CONCEPTS

SYM.	RUN	SEC/PRI. FLOW RATIO	PRI. PRESS.	PRI. EQUIV. RATIO	A/B EQUIV. RATIO	SIM. ALTITUDE	DYNAMIC PRESS.
O	37	3.24	4.94	0.97	0.84	45,200	1920
O	25	3.12	4.96	0.96	0.85	46,500	1800
L	37	2.70	4.95	0.96	0.83	50,000	1525
D	37	2.35	4.95	0.95	0.85	52,300	1360
D	22	1.70	4.95	0.95	0.82	59,000	990

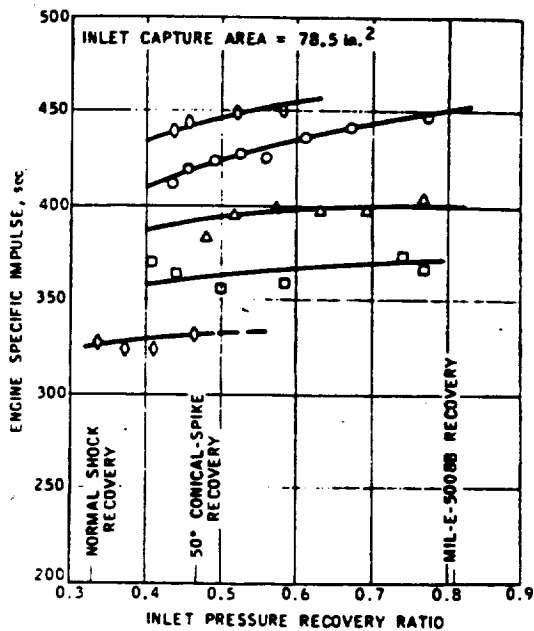

MA191-B1 EJECTOR RAMJET ALTITUDE PERFORMANCE
MACH 3.0 EJECTOR MODE

SYM.	RUN	SEC/PRI. FLOW RATIO	PRI. PRESS.	PRI. EQUIV. RATIO	A/B EQUIV. RATIO	SIM. ALTITUDE	DYNAMIC PRESS.
△	37	1.82	496	0.94	1.00	42,000	900
□	28	2.08	504	0.94	0.87	38,500	1060
○	28	2.65	501	0.93	0.87	33,000	1370
○	PREDICTED						

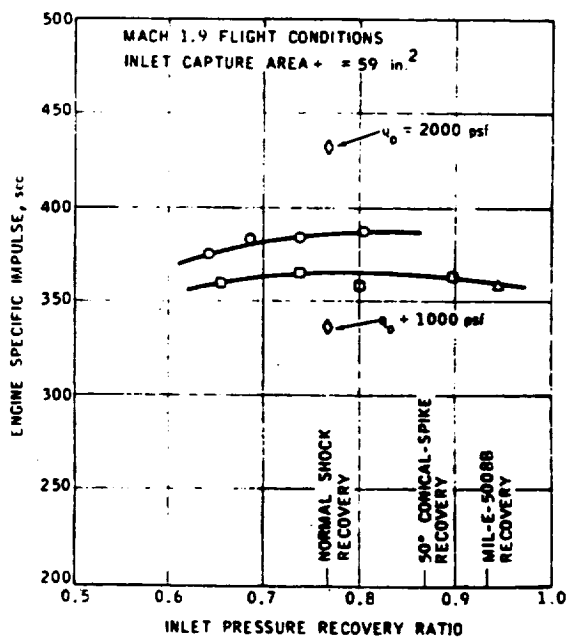

MA191-B1 EJECTOR RAMJET ENGINE PERFORMANCE
EJECTOR RAMJET OPERATING MODE
ALTITUDE OPERATION

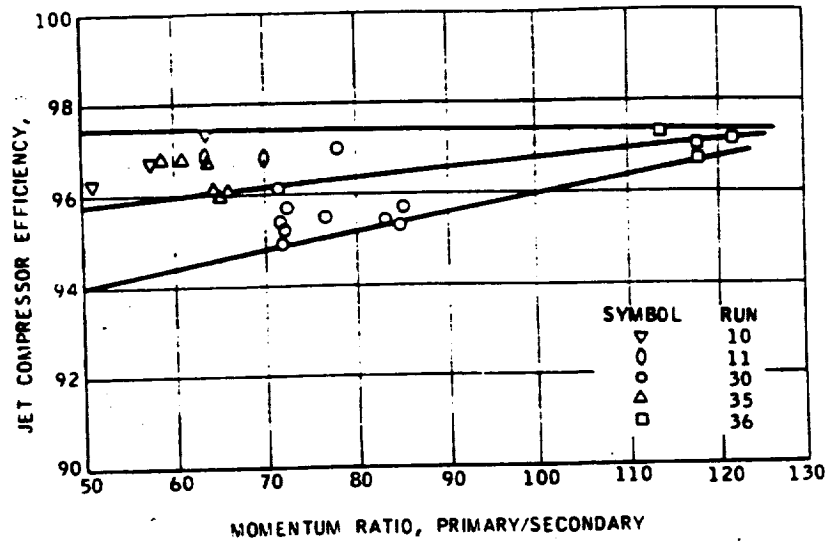

MA191-B1 EJECTOR RAMJET ENGINE PERFORMANCE
 JET COMPRESSOR PERFORMANCE VERSUS MOMENTUM
 RATIO - PRIMARY/SECONDARY

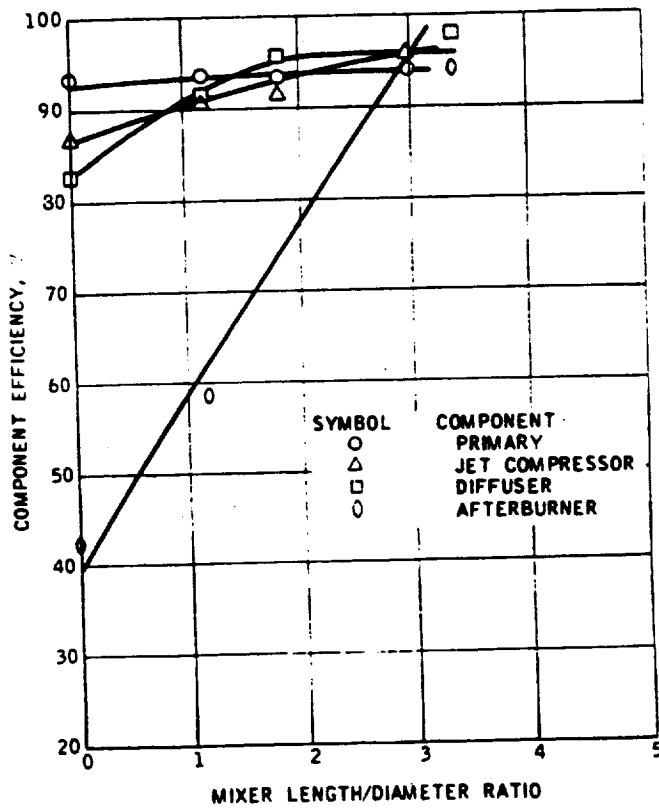

MA191-B1 EJECTOR RAMJET ENGINE PERFORMANCE
 COMPONENT EFFICIENCY VERSUS MIXER LENGTH/DIAMETER RATIO

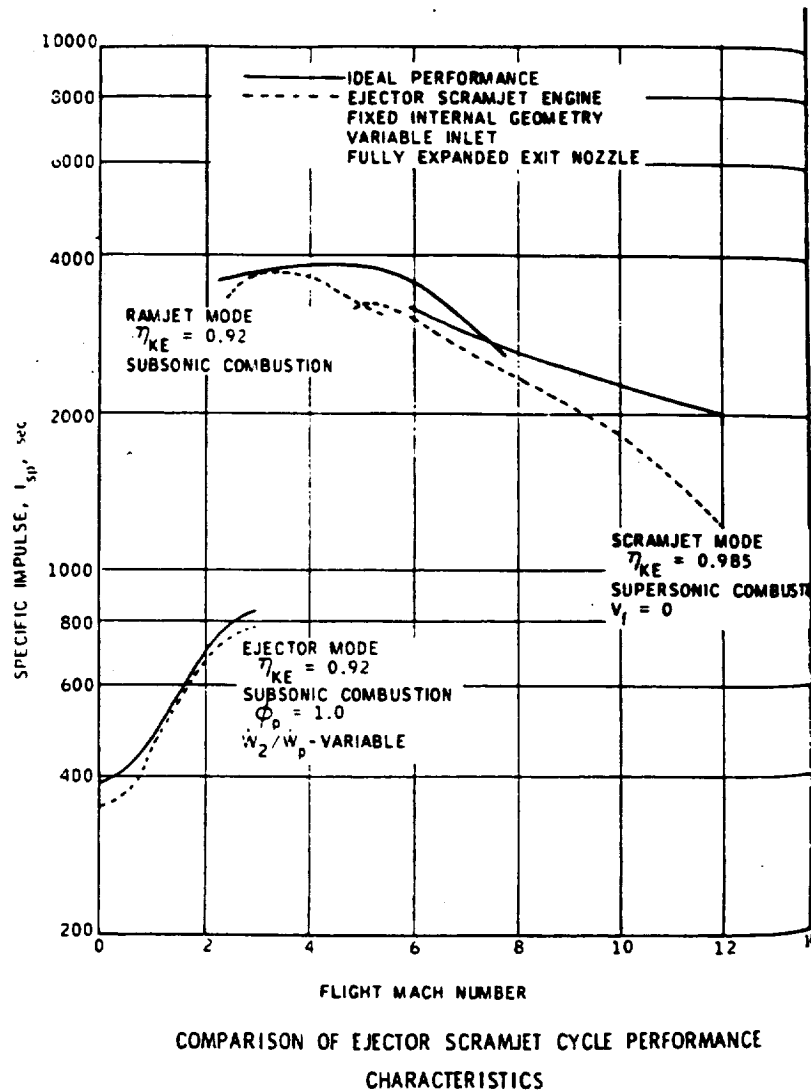



1992012219
628250

N92-21521 10p.

THE NASA HYPERSONIC RESEARCH ENGINE PROGRAM

Kennedy F. Rubert
National Aeronautics and Space Administration
Langley Research Center
Hampton, VA 23665

and

Henry J. Lopez
Allied-Signal Aerospace Company
Torrance, CA 90504-6099

INTRODUCTION

This paper provides an overview of the NASA Hypersonic Research Engine Program, describes the engine concept which was evolved, and summarizes the accomplishments of the program.

The National Aeronautics and Space Administration undertook the Hypersonic Research Engine Program (HREP) as an in-depth program of hypersonic airbreathing propulsion research to provide essential inputs to future prototype engine development and decision making. An airbreathing liquid-hydrogen-fueled research-oriented scramjet was to be developed to the performance goals shown in Figure 1. The work was many faceted, required aerodynamic design evaluation, structures development, and development of flight systems such as the fuel and control system, but the prime objective was investigation of the internal aerothermodynamics of the propulsion system. At flight speeds below Mach 6, the combustion mode was to be at the contractor's option; above Mach 6, supersonic combustion was specified.

RESEARCH ENGINE CONCEPT

To meet these requirements, an axisymmetric dual-combustion mode design illustrated in Figure 2 was selected. The capture diameter was 0.457 meter (18 in.), the area of the exit nozzle was twice the capture area, and the overall length with the translating spike in the full-forward closed position was 2.13 meters (84 in.). An external-internal compression inlet having a significant degree of external compression minimized inlet wetted surface and associated cooling load. Translation of the inlet spike provided for adjustment of the internal area contraction at higher flight speeds and minimization of inlet spillage at lower flight speeds.

PROGRAM EVOLUTION

At its inception, the hypersonic research engine program plan provided for aerothermodynamic development, first at the subscale component level, followed by component integration and engine performance at full scale for a concurrent development of structures and subsystems, and then for airborne experiments which would be the culmination of the program. This program

was subsequently restructured to accommodate retirement of the X-15 flight test vehicle and deactivation of an intended ground-based facility. These program changes redirected structural evaluation toward Mach 7 true-temperature testing in the Langley 8-foot high-temperature structures tunnel of an assembly of the structural components (the structures assembly model, SAM, Figure 3) as the final act in structural development. The restructured program retained aerothermodynamic development essentially unchanged except for the deletion of the final step, building and flight testing of the unified product. Flight system development, having already reached a point where feasibility was insured, was discontinued.

FUEL SYSTEM

The hydrogen system, Figure 4, consisted of a number of circuits supplied by a turbine-driven pump and regulated by special-purpose valves all under command of a digital computer which provided overall control of the system. Four high-pressure cryogenic valves distribute the hydrogen among the engine cooling passages and three high-temperature valves of 922°K (1200°F design) redistribute the collected hot jacket effluent to the fuel injectors. In addition, a turbine control valve regulated the flow of hot hydrogen to the pump drive, and a waste (dump) valve permits operating the system when desired at engine fuel-consumptions values below coolant requirements. The computer provides all logic and control signals necessary for (1) operating the translating inlet spike, (2) operating the combustor fuel feed and distribution as required by speed and altitude for programmed equivalence ratios, (3) regulating the coolant flows in the several circuits to maintain desired skin temperatures, and (4) performing numerous safety and self-checking functions.

STRUCTURES

The SAM configuration was the culmination of the structures research and development effort and reflects the design concepts evolved for the flight engine. The configuration is a Hastelloy X plate-fin monocoque structure with local stiffening as required to resist buckling. The stiffening rings double fuel-injection manifolds or fuel collector manifolds. The SAM is hydrogen cooled except for a water-cooled cowling outer surface which is part of the wind-tunnel installation. A hydraulic actuator was incorporated in the design to provide for positioning of the variable-geometry inlet.

In as much as the vitiation-heated test facility lacked the oxygen replenishment required for testing with combustion, the SAM was fitted with only a single row of fuel injectors. This model was successfully tested at a nominal Mach 7 true temperature and altitude. In the SAM, as in a complete engine, the aerodynamic interferences are reproduced which cause uneven heating and the thermal expansions that give rise to structural interactions. The SAM investigation demonstrated the capability, by appropriate design, to cope with nonlinearities and other peculiarities inherent in a total engine structure.

THERMODYNAMIC COMPONENT DEVELOPMENT

Aerodynamic development at the component level was done at reduced scale with a view to arriving at preferred component characteristics, and experimental verification thereof, at

minimum time and cost. Combustion studies were made by using a quasi-two-dimensional variable-geometry combustion rig provided with separately heated test stream (vitiating and oxygen replenished) and gaseous hydrogen fuel. Subsonic and supersonic combustion modes were investigated in this rig. Combustion efficiencies in excess of 95 percent were shown to be quite attainable, and an initial investigation of the complex inter-related problems of staged injection in diverging supersonic combustion was made. These studies indicated poor efficiencies for supersonic combustion in a diverging duct. This investigation showed a need for further research at full scale and with better simulation.

FULL-SCALE PERFORMANCE ENGINE

The aerothermodynamic integration model (AIM, Figure 5) was the "proof of the pudding" for the aerothermodynamic design of the engine. The engine configuration reflects the aerodynamic contours established in the subscale component program. The engine is constructed from nickel and is water-cooled. Heavy duty, nonflight, laboratory models such as the AIM are commonly referred to as "boilerplate" models, a somewhat misleading term. The thick-plate construction at high heat fluxes necessitated a very sophisticated structural design and placed unusually severe demands on the fabrication technology. For example, zirconium copper was required to form the tip of the cowl leading edge, where the thermal conductivity and high-temperature strength requirements exceeded the capability of nickel 200. Because of stress and dimensional stability requirements, explosive bonding was used for attaching the copper tip to the nickel. Water cooling was elected as a matter of convenience in testing and controlled such that proper simulation of the temperature of the hydrogen-cooled flightweight wall could be obtained at points of importance. Heated hydrogen was used to properly simulate the flight engine combustion and ignition characteristic in the burner. The design had provisions for 266 pressure measurements, 138 temperature measurements, and 5 gas sampling probes. The engine was tested at the NASA Lewis Plum Brook Facility at Mach 5, 6, and 7. The facility was capable of providing nonvitiating, true temperature simulation over this Mach range up to a total pressure of 81.5 atm (1200 psia).

RESULTS

The combustion efficiency levels measured in the AIM are presented in Figure 6. Figure 7 presents the experimental data compared to the predicted performance. The overall conclusions from the AIM model are presented in Figure 8. The total test time is shown in Figure 9.

The SAM model was thermally cycled in the Langley 8-ft. high temperature structures tunnel. The measured heat fluxes and surface temperatures are shown in Figures 10 and 11. Total test time in the tunnel is shown in Figure 12. These tests indicated at the time that the design of regenerative cooled flightweight structure capable of taking variable highly non-uniform heat loads was feasible.

The HRE program was the only program in its day that totally addressed all the issues facing the design of a high Mach number hydrogen cooled supersonic combustion ramjet.

HRE PERFORMANCE GOALS

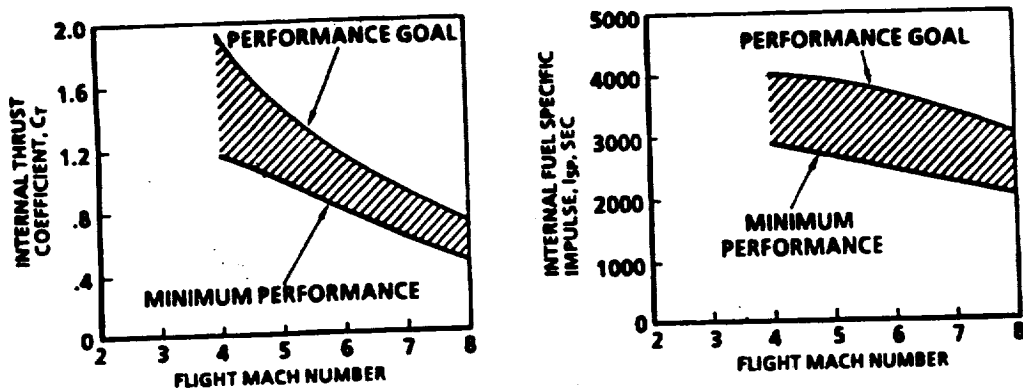
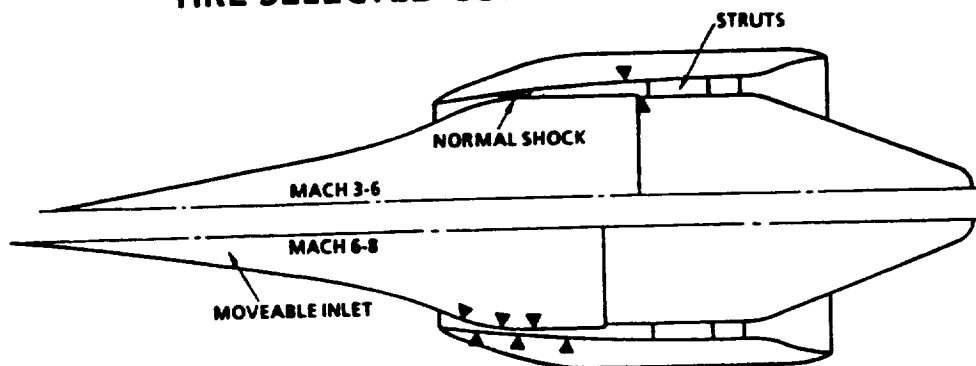

FIGURE 1

HRE SELECTED CONFIGURATION



- **AXISYMMETRIC**
 - INLET DIAMETER = 18.0 IN.
 - EXIT DIAMETER = 25.1 IN.
 - ENGINE LENGTH = 86-91 IN.
- **HIGH INLET CONTRACTION RATIO**
 - VARIABLE GEOMETRY
- **DISTRIBUTED COMBUSTION**
 - SUBSONIC COMBUSTION, $M_0 = 3$ TO 6
 - SUPERSONIC COMBUSTION, $M_0 = 6$ TO 8

▲ FUEL INJECTORS

FIGURE 2

HRE SAM ENGINE ASSEMBLY

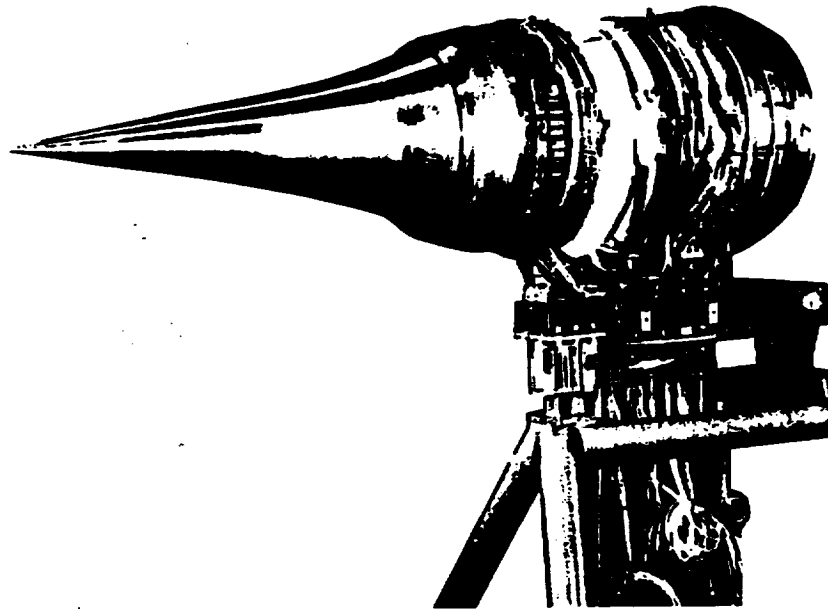

FIGURE 3

FUEL AND CONTROL SYSTEMS

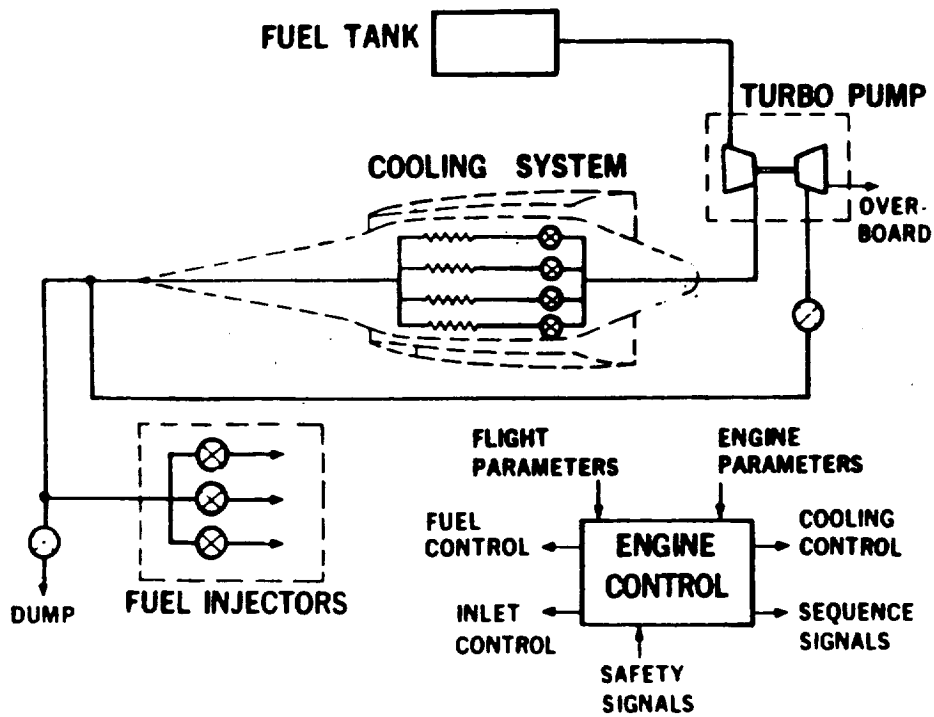

FIGURE 4

AIM FINAL ASSEMBLY

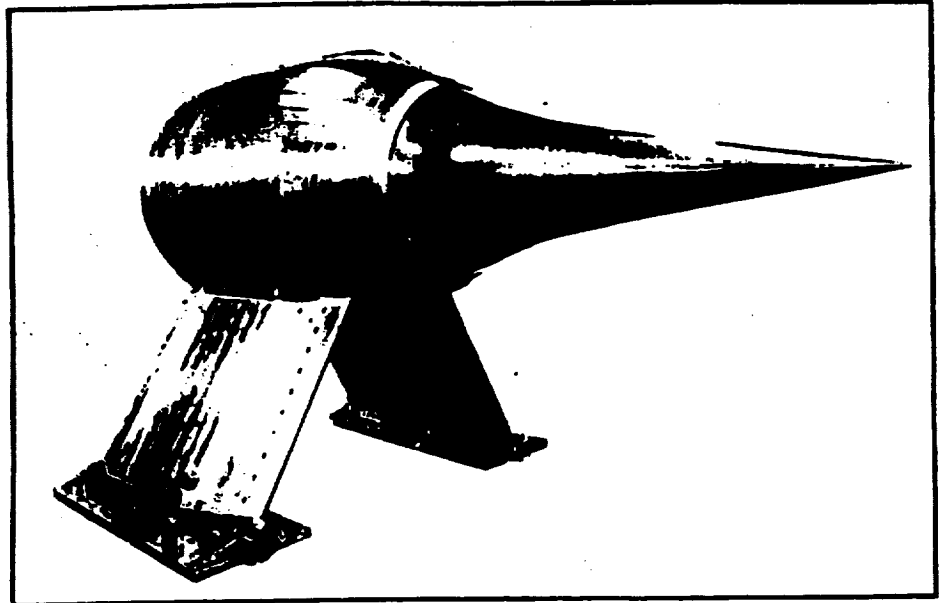

FIGURE 5

MACH 6 SUPERSONIC COMBUSTOR EFFICIENCY

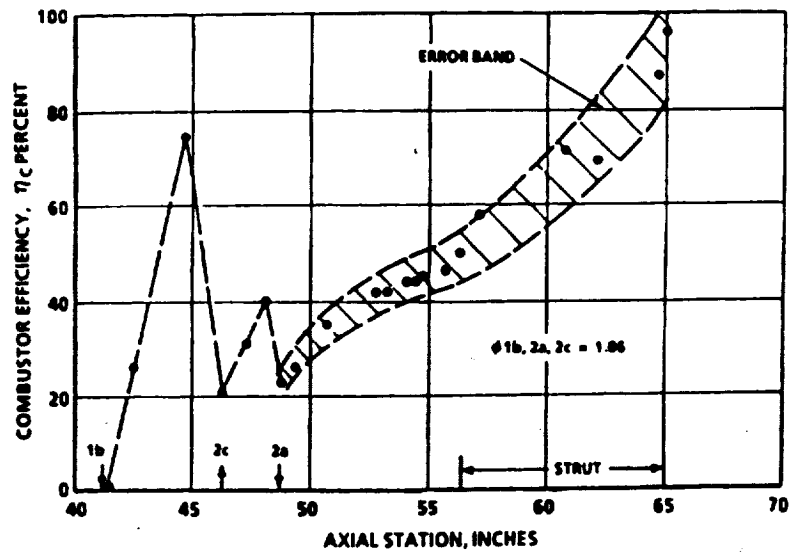

FIGURE 6

CORRECTED MACH 7.25 INTERNAL PERFORMANCE SUPERSONIC COMBUSTION

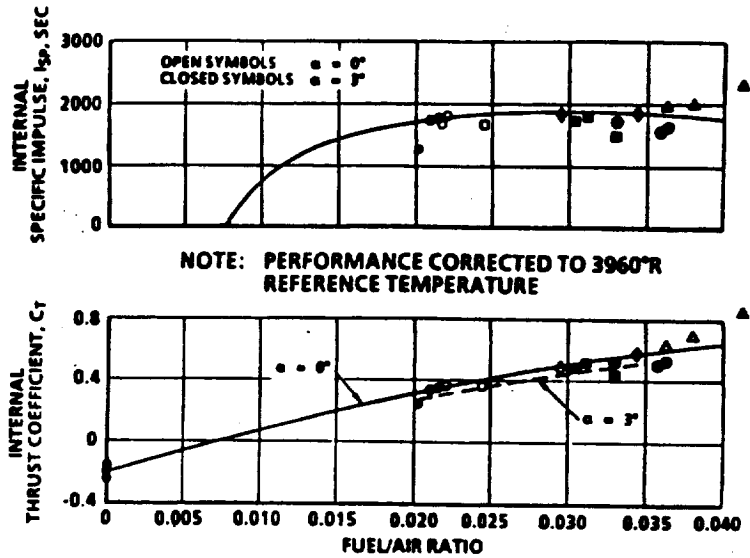

FIGURE 7

AIM INTERNAL PERFORMANCE COMPARISON

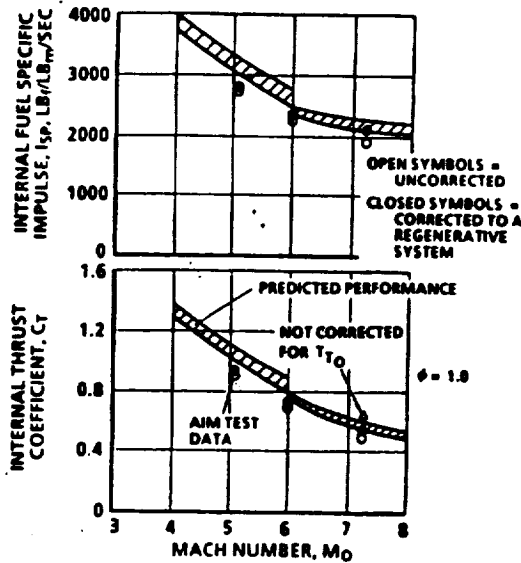

FIGURE 8

TEST SUMMARY

MACH NO.	NO. OF TESTS	TIME AT TEST COND (SEC)	P _{TO} (PSIA)	T _{TO} (°R)
5	5	19' 30"	210/415	2210/3000
6	36	63' 17"	466/750/930	1500/3000
7	11	28' 57"	1000	3000/3500
52		111' 44"		

● TEST PERIOD

- MACH 6 FROM OCT 5, 1973 TO DEC 19, 1973
- MACH 7 FROM JAN 22, 1974 TO MAR 18, 1974
- MACH 5 FROM MAR 20, 1974 TO APR 22, 1974

FIGURE 9

HEAT FLUXES

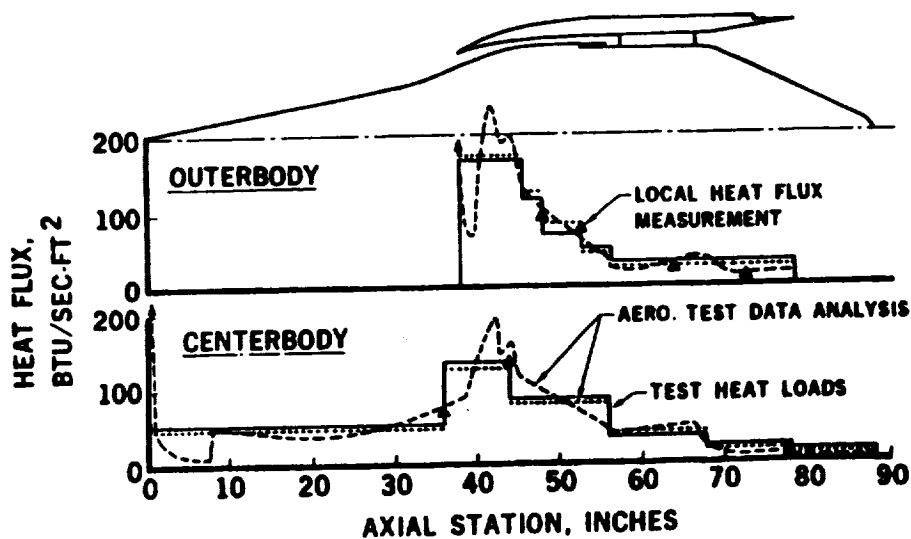

FIGURE 10

SURFACE TEMPERATURES

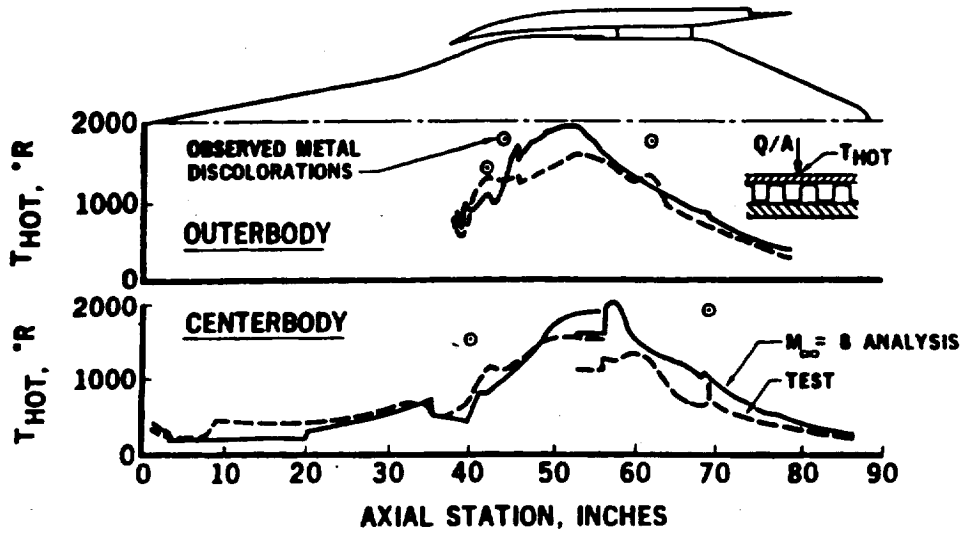

FIGURE 11

WIND TUNNEL TESTS THERMAL FATIGUE SUMMARY

TUNNEL TOTAL CONDITIONS		NO. OF CYCLES	TIME IN STREAM, SEC	AVG. CYCLE TEMPERATURES		DAMAGE FRACTION, PERCENT
PSIA	°R			T _{MAX.} °R	ΔT, °R	
950	2600	5	172	1360	733	1.30
1300	2700	3	135	1445	950	2.12
1380	2700	33	851	1446	906	20.50
1500	2700	3	138	1571	1152	3.77
2200	3000	5	266	1591	1287	8.36
2800	3300	1	58	1435	1224	1.19
3300	3400	5	163	1522	1350	8.46
TOTALS		55	1783			45.70
			29.7 MIN.			

FIGURE 12

HYPERSONIC AIRBREATHING PROPULSION/AIRFRAME INTEGRATION

John P. Weidner
National Aeronautics and Space Administration
Langley Research Center
Hampton, VA 23665

Recent interest in airbreathing hypersonic flight has centered around the need to develop advanced space launch systems which can reduce the cost of inserting payloads in orbit and make space more accessible. An effect of the thermal environment is to require the vehicle to operate at high altitudes, in very thin air, to maintain aircraft structural load limits. The high altitudes at which the hypersonic vehicle must operate give rise to the concept of an airframe integrated propulsion system (Fig. 1) to provide a much larger inlet and nozzle to process the required volume of air at low-density, atmospheric conditions. In the integrated system, the forward portion of the vehicle compresses the airflow and serves as the external portion of the inlet; the aftbody completes the expansion process for the nozzle. In addition the engine, which is contained between the body and the forebody shock wave, lends itself to a modular integration of a number of separate engines. In this manner a relatively small engine can be defined to allow engine development in existing ground facilities.

The large forebody and aftbody lead to unique problems associated with the hypersonic vehicle. Figure 2 illustrates a poor forebody design in that the static pressure distribution ahead of the propulsion modules results in a large accumulation of boundary layer in the center of the forebody. Such an airflow distribution would cause an unacceptably thick boundary layer and airflow loss in the center propulsion module. The importance of finite-rate chemistry at high speeds in calculating lateral airflow distribution as well as flow-field profiles between the body and cowl is also illustrated in this figure. The aftbody is unique in that a large portion of the airframe surface becomes involved in producing thrust. Figure 3 is an example of tests that have been conducted on a nozzle aftbody to determine performance characteristics. Parametric tests included the nozzle sidewall fence and air or stimulant gas to represent the nozzle exhaust flow. The stimulant gas was a cold mixture of gases intended to properly reproduce the engine exhaust flow ratio of specific heats throughout the nozzle expansion process. Note that measure nozzle forces are increased when the exhaust flow is simulated as compared to results using air. In addition, increases in nozzle thrust and lift occur when a flow fence is installed since the nozzle is not overexpanded and exhaust flow containment within the nozzle maximizes thrust at higher speeds. In contrast, at transonic speeds a configuration without sidewalls would have less base drag since the nozzle is overexpanded and outside air must be allowed to bleed into the base region.

The wide Mach number range of operation required by an SSTO vehicle also imposes unique challenges on the design and performance of the hypersonic engine module. Operation of both the turbojet and ramjet cycles at the same time requires separate combustors and nozzles as illustrated by Figure 4. Choking the two flows separately using independent operating nozzle throats allows each flowpath to be backpressured separately. Possible advantages include increased thrust and a smoother transition between the two cycles. More efficient methods for

combining the turbojet and ramjet intakes have been explored, and have resulted in an arrangement where the ramjet is located under the turbojet rather than having the ramjet combustor wrapped around the turbojet engine (Figure 5). This concept results in a higher level of integration between the turbojet and ramjet intakes. At high speeds when only the ramjet is operating, the supersonic portion of the inlet is identical between the two concepts (Fig.6), whereas at low speeds a portion of the supersonic inlet opens to form an additional inlet for the turbojet. More independence between the two engine cycles results, thereby allowing internal ducting to be designed specifically for each cycle. A major advantage of the over/under turboramjet arrangement is that the high speed cycle is no longer restricted to a ramjet, and may include a dual-mode scramjet.

Contemporary dual-mode engines include the Parametric Engine tested at Langley Research Center (Figure 7). This concept represents an airframe-integrated engine built around a sidewall compression inlet approach. However tests have been expanded to include other shapes such as the 2-D class of engines which may integrate better with the turbojet engine. Tests so far have been conducted at a small scale, limited by facility size, and have included only limited forebody effects resulting from integration with the airframe. The 2.44 meter High Temperature Tunnel at Langley has been recently modified to include propulsion testing in addition to its usual role as a structures test facility (Figure 8). This large facility will allow extensions of previous tests to include airframe integration and multiple module effects with the engine size illustrated in Figure 7, as well as a larger scale engine to allow studies of engine scale effects and to include realistic structure within the test module.

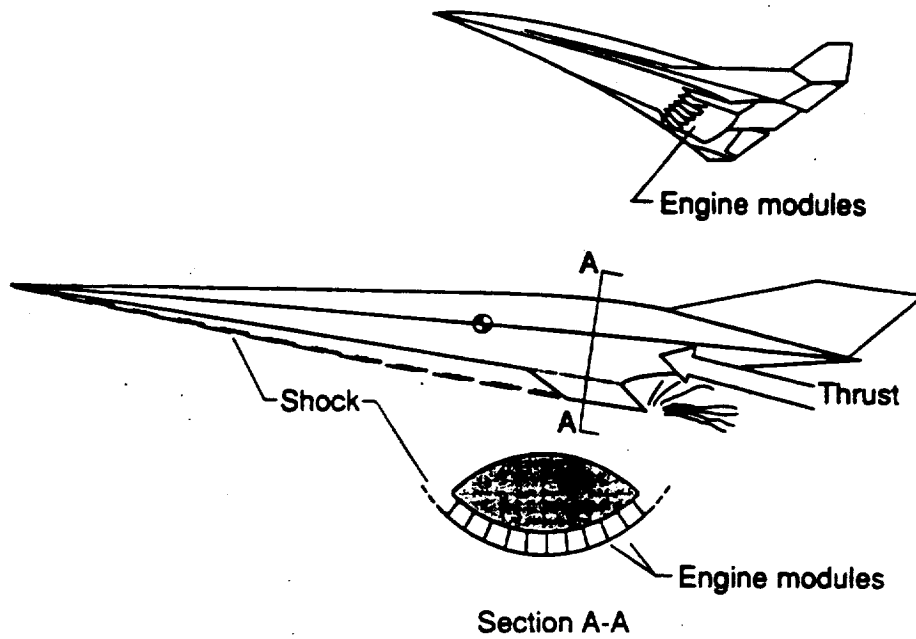

Figure 1.- Hypersonic engine/airframe integration

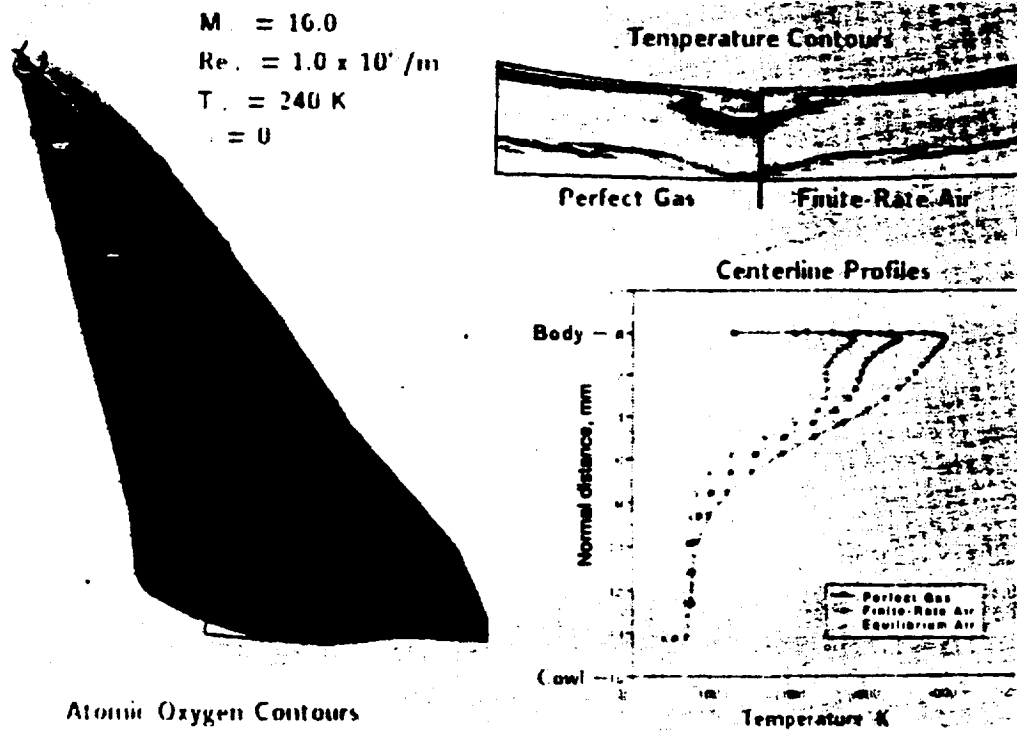

Figure 2.- Forebody analysis on a typical SSTO vehicle

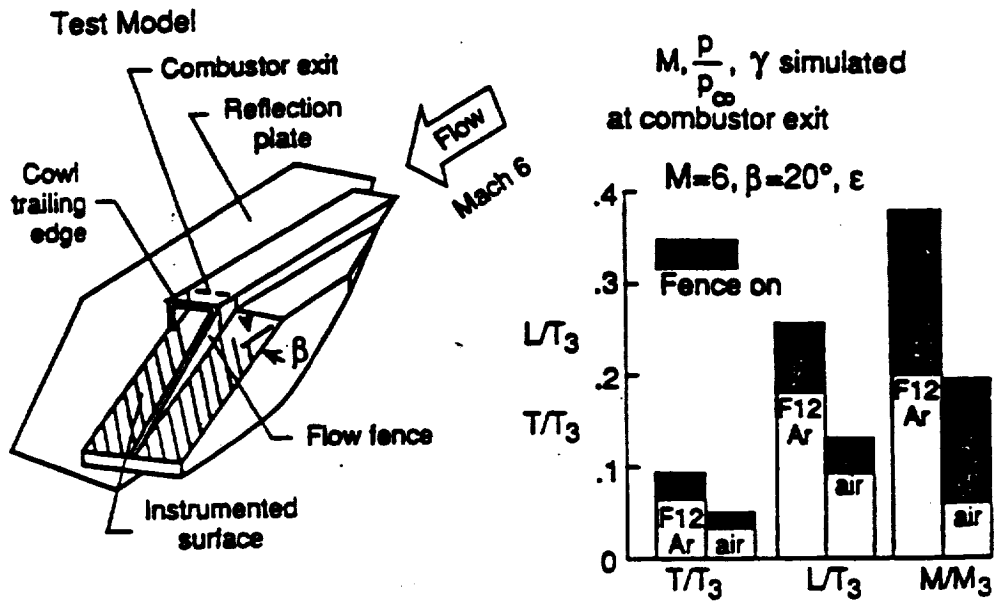
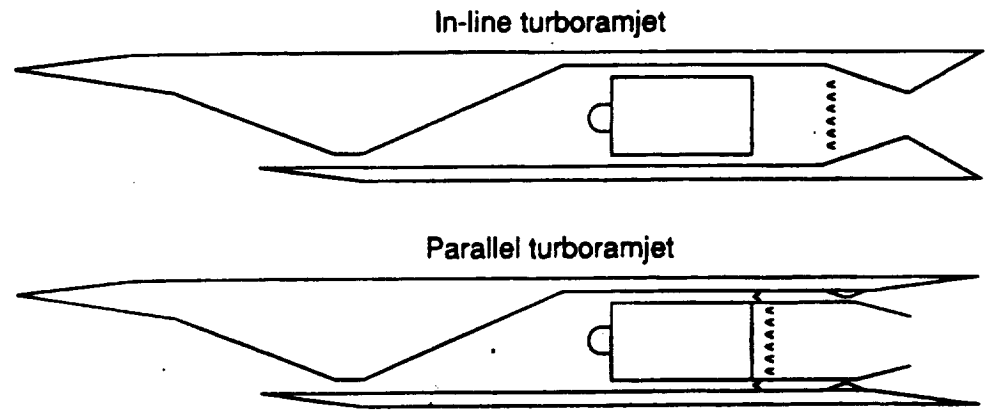

Figure 3.- Hypersonic nozzle exhaust simulation; effect of flow fence and simulant gas



Fundamental difference in parallel approach

- Dual combustors & nozzle throats
- Simultaneous turbojet & ramjet operation
- Inherently heavier

Figure 4.- In-line vs parallel turboramjet

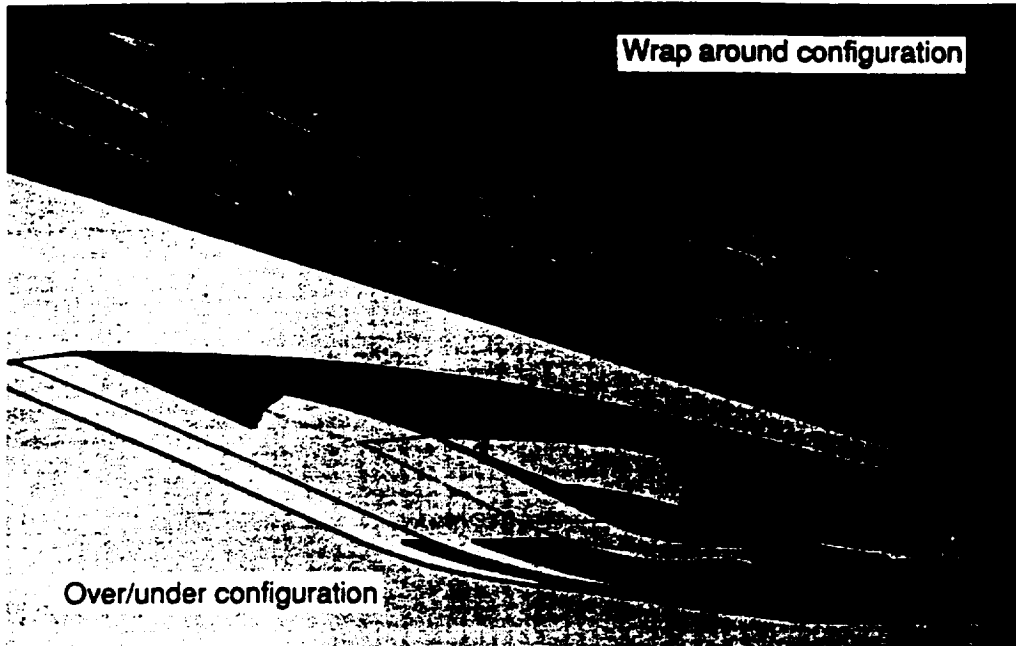

Figure 5. - Turboramjet Mach 5 propulsion system

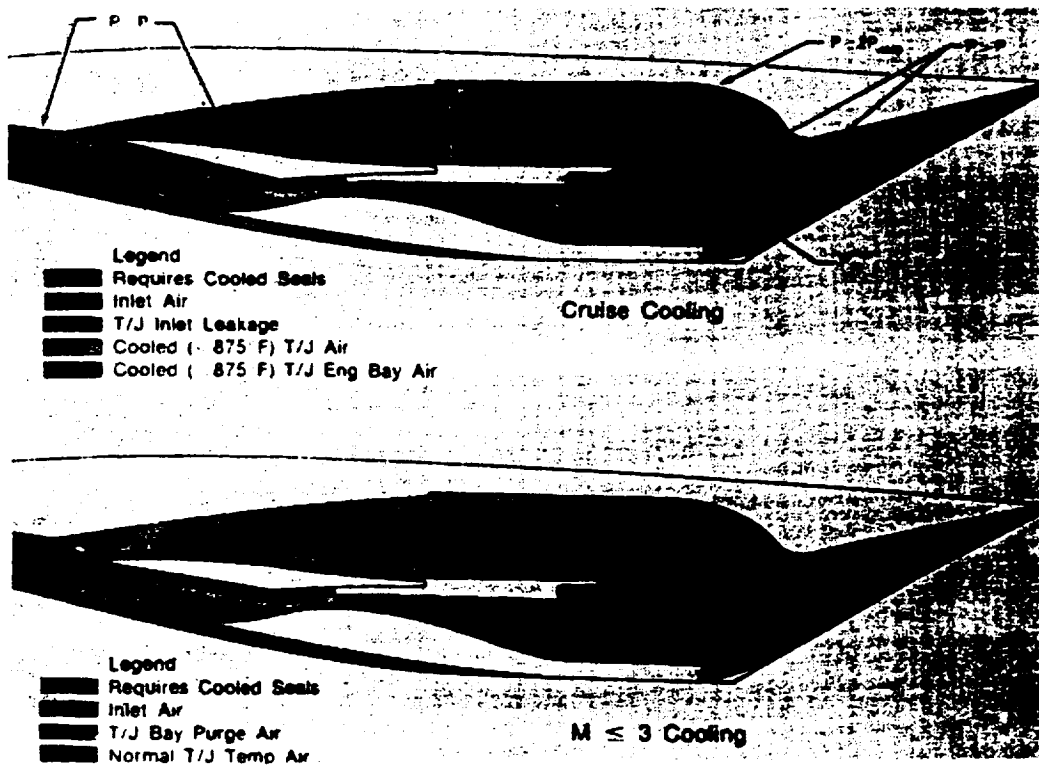
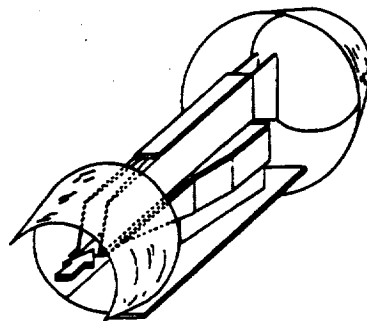
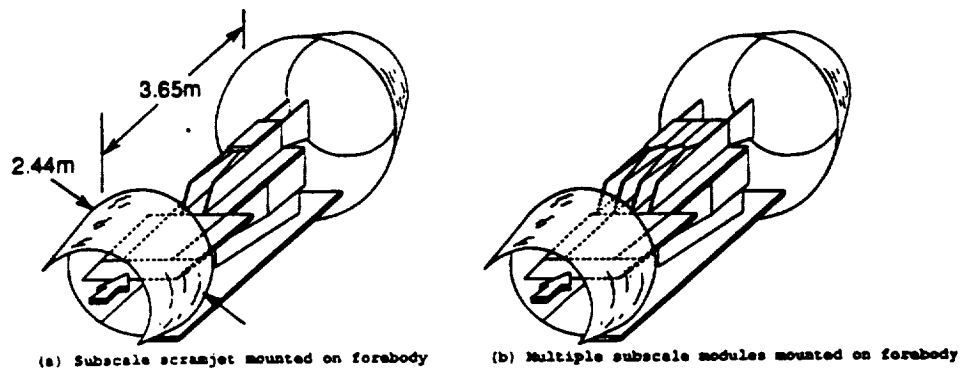

Figure 6. - Separate turbojet/ramjet engine concept



Figure 7.- Langley Parametric Engine



(c) Larger scale scramjet

Figure 8.- Scramjet tests planned for the 2.44-meter ETT

ORIGINAL PAGE IS
OF POOR QUALITY

N 9 2 - 2 1 5 2 3

AIRBREATHING COMBINED CYCLE ENGINE SYSTEMS

John Rohde
NASA Lewis Research Center
Cleveland, Ohio

1992012281
628253
10p.

The Air Force Wright Research and Development Center's Aero Propulsion and Power Laboratory (WRDC/PO) and the National Aeronautics and Space Administration's Lewis Research Center (NASA LeRC) share a common interest in developing advanced propulsion systems for commercial and military aerospace vehicles which require efficient acceleration and cruise operation in the Mach 4-6 flight regime. The principal engine of interest is the turboramjet; however, other combined cycles such as the turbosramjet, air turborocket, super-charged ejector ramjet, ejector ramjet, and air liquefaction based propulsion are also of interest. Over the past months careful planning and program implementation have resulted in a number of development efforts that will lead to a broad technology base for these combined cycle propulsion systems. Individual development programs are underway in thermal management, controls materials, endothermic hydrocarbon fuels, air intake systems, nozzle exhaust systems, gas turbines and ramjet ramburners.

In 1986, NASA LeRC and WRDC/PO initiated studies with Rolls-Royce, General Electric, and Pratt and Whitney to evaluate and configure advanced combined cycle propulsion systems/fuels for future mission applications. Two missions were selected; a long duration cruise vehicle (Mach 4-6) and a horizontal takeoff two stage-to-orbit vehicle. The three studies were consistent in selecting turbomachinery based combined cycle engines as the preferred cycle. A number of critical component technologies were identified during the studies which must be investigated before a turbomachinery based combined cycle engine can be demonstrated. A few of the more critical component technologies are discussed.

THERMAL MANAGEMENT

The maximum speed for high Mach aircraft will be established by the thermal management system. Design practice has been to employ fuel/air heat exchangers to provide cooling air for many of the engine components while the airframe was cooled by passive means. Flight in the Mach 4-6 regime can result in leading edge temperature as high as 1800°F from aerodynamic heating. The engines will operate with compressor exit and turbine entrance temperatures that approach the limits of standard structural materials. The thermal loads from the airframe, avionics, crew environment, and engines will increase greatly above the levels normally handled by the incoming air and standard hydrocarbon fuels. Therefore, thermal management systems for the high Mach applications must resort to the heat sink capability of advanced fuels since even the stagnation air temperature will exceed the materials structural limit in many cases.

Endothermic hydrocarbon fuels show promise of handling the higher heat loads of the high Mach aircraft up to flight speeds exceeding Mach 6.0. Fuel temperatures of 1400°F and pressures to 500 psi are indicated after passage through the thermal management system loop. Advances in every component of the fuel management system will be required including pumps, regulators, tubing, connectors, heat exchangers, catalytic reactors, etc. System architecture

studies will be required to ensure proper arrangement of components for minimum weight systems.

AIR INTAKE SYSTEMS

The air intake system for the high Mach aircraft poses a number of unique design requirements not found in lower speed applications. Matching the air capture schedule versus engine airflow demand over a broad speed range requires compromise at the operating extremes. Excess spillage drag at low speed requires higher thrust since spillage drag can be as much as 25% of the total vehicle drag at transonic conditions. Boundary layer limit will be required to limit the amount of low energy air entering the propulsion system. Control can be achieved through boundary layer bleed or regulating the temperature ratio between the freestream air and the inlet surface. Temperature control of the inlet surface may unduly complicate the thermal management system. It has been shown that 1% bleed flow can cause up to 5% reduction in net thrust. The inlet designer must account for the air flow that is required to cool the engine hot section, lubrication system, and exit nozzle. Cooling air flow up to 15% of that captured may be required. Inlet physical size may in fact be the largest design problem. Preliminary designs of air intakes show that the configurations will be as much as three times larger and weigh four times heavier than those for Mach 1.5 aircraft. Innovative thinking will be required to keep the inlets short and light.

EXIT NOZZLE

The engine exit nozzle will be required to operate efficiently over a wide speed range. Optimal contouring of the expansion surface will be necessary since even a 1% change in gross-thrust coefficient can result in an 8% reduction in net thrust. Variable geometry components will be required to accommodate the large expansion ratios, up to 40:1 at Mach 6, to expand the exhaust flow to ambient pressure. Variable geometry by its very nature poses a sealing problem and can result in leakage of very hot exhaust gases, around 4500°R, into the actuator compartments. Nozzle structure and cooling become critically important at these high speed conditions. Nozzle size and weight problems are magnified with variable geometry and added cooling that must be taken into account. Preliminary nozzle designs indicate that weight and size may be as much as four times that of a conventional nozzle for a Mach 1.5 aircraft.

RAMJET COMBUSTOR (RAMBURNER)

The ramburner must withstand the thermal environment and structural loads from Mach 1.5 to 6.0. If the mission application happens to involve a man-rated system, the structural duty cycle can extend to many cycles for extended periods of time. As a structural goal, a duration of two hours per flight for 250 flights seems reasonable. To minimize the size of the ramburner cross-section stoichiometric fuel/air operation could be required with associated gas temperatures around 4500°R. Ramburner walls are likely to be cooled with air or direct fuel cooling in a regenerative structure. Flameholders and fuel injectors will likely be fixed instream devices with associated thermal cooling problems. Low air temperature (e.g. low speed) ramburner operation may require a pilot excessively large flameholder for flame stabilization. These are contrary to the requirements at high temperature where fuel/air autoignition will be achieved easily. Prior

combustion data suggest that the mixing limited condition exists at high temperature and more instream fuel injectors may be needed to achieve high efficiency. Liquid and gaseous fuel injection will be required and will add further complication to the injector design.

COMPONENT INTEGRATION

Component integration will be the ultimate challenge in demonstrating a complete propulsion system that has good overall performance and minimum weight. Mode transition control must be accomplished smoothly without causing disruption of any component. For example, the gas turbine compressor should have wide stall margin limits and stable windmilling characteristics for smooth shutdown and restart. For sustained speeds above Mach 4, it will become necessary to thermally isolate the gas turbine since the air temperature will be too high for the structural materials and bearing lubrication system. Engine thermal control must consider cooling air flow path and flow rate requirements to maintain structural integrity. Air flow management for the engine internally will require variable geometry in the form of compressor inlet guide vanes or some air valve in the inlet subsonic diffuser to seal and direct the air flow to the appropriate operating mode. Engine controls will necessarily be more complex than usual to maintain optimum settings for the inlet, nozzle and internal engine components.

OTHER CONTRIBUTING PROGRAMS INCLUDE

The heat pipe radiation cooling for high-speed aircraft propulsion program, the ceramic regenerator program, the endothermic fuel/catalyst development and evaluation program, the endothermic fuels program, the inlet and nozzle concepts for advanced airbreathing propulsion program, fundamental ramburner combustion studies, high speed turboramjet combustor development program, and the high mach turbine engine technology program.

The High Mach Turbine Engine Technology to be demonstrated over this next decade will open up a new era in mission applications and tactics by doubling the speed range capability of current systems. High speed intercept and early warning equates to effective deterrence; a cornerstone in our strategic defense philosophy. Timely reconnaissance and surveillance improves response flexibility and decision time so that measured responses can be made without overreacting to situations. In fluid situations where targets and scenarios are constantly changing, rapid strike capability keeps time urgent targets at risk. A simple force projection to show national interest/resolve might prevent potential adversaries from taking steps to increase hostilities. High speed can also improve system survivability and provides a hedge against anti-stealth technology breakthroughs.

Commercial applications for this engine technology include high speed passenger/transport aircraft and accelerator stages for horizontal takeoff, earth-to-orbit launch vehicles. As the Pacific Basin area evolves as a strong economic area, timely access to this region from the United States and Europe for both passengers and materials will be important economically. Interest in low-cost access to space and the ever increasing backlog of payloads has fueled national interest in alternate methods to achieve launch capabilities. Reusable launch vehicles have been studied by a number of countries. The turboramjet using hydrogen fuel has in many cases shown to be the preferred low speed propulsion system for these vehicles.

This technology will allow the United States commercial aviation industry to maintain a clear leadership in response to foreign pressures from Germany, France, Japan, and the Soviet Union, and to continue to be a strong source for domestic and international aircraft.

HYPERSONIC BREAKTHROUGH OPPORTUNITIES

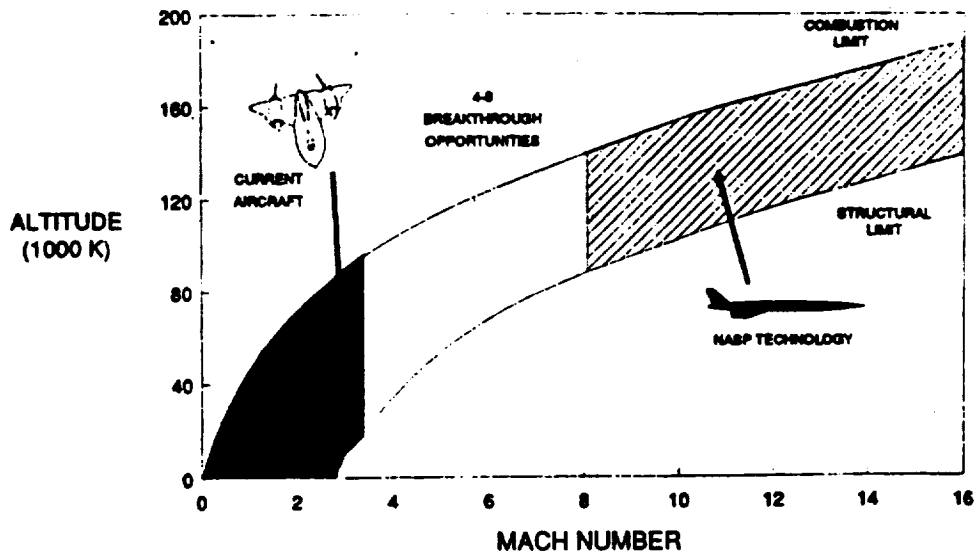

COMBINED CYCLE ENGINES

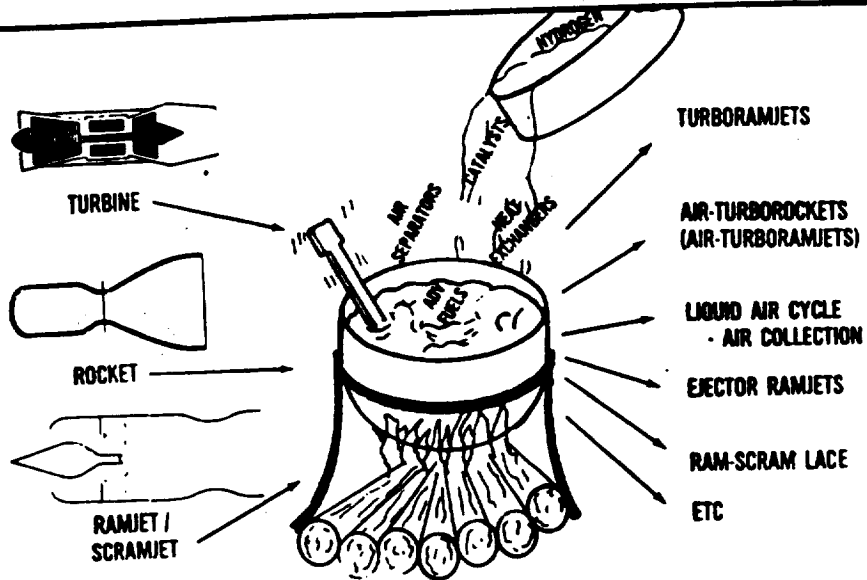

ENDOTHERMIC FUEL SYSTEM

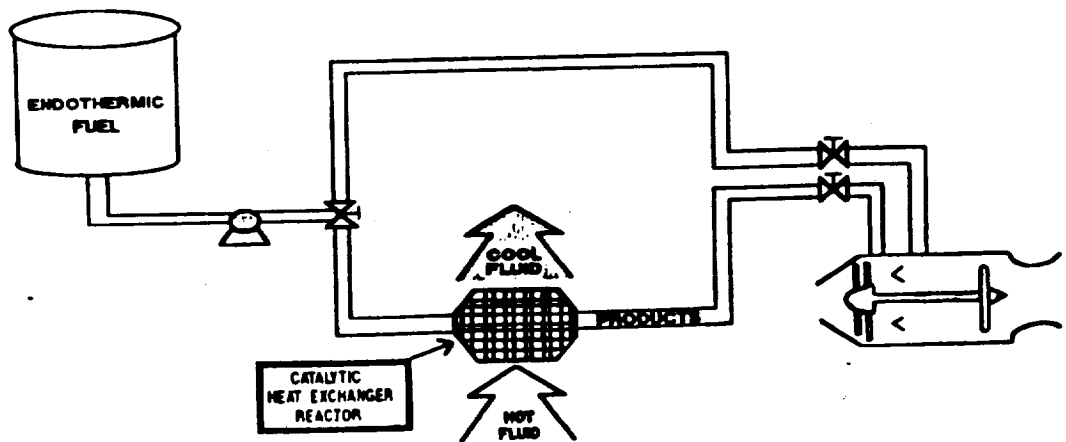

THE SOLUTION TO THE 4 - 6 TECHNOLOGY GAP

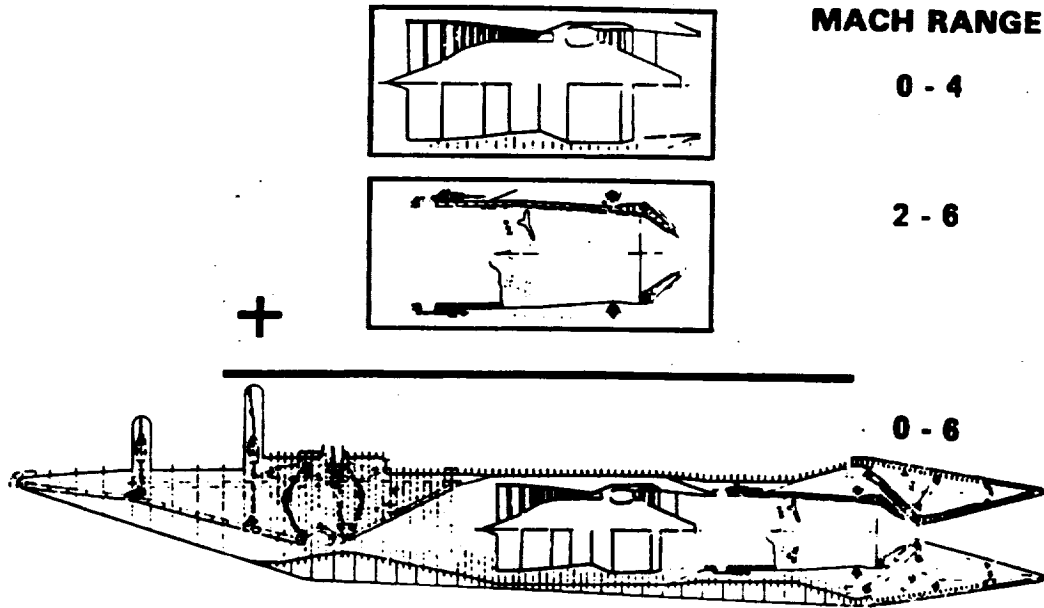

ENDOTHERMIC FUELS

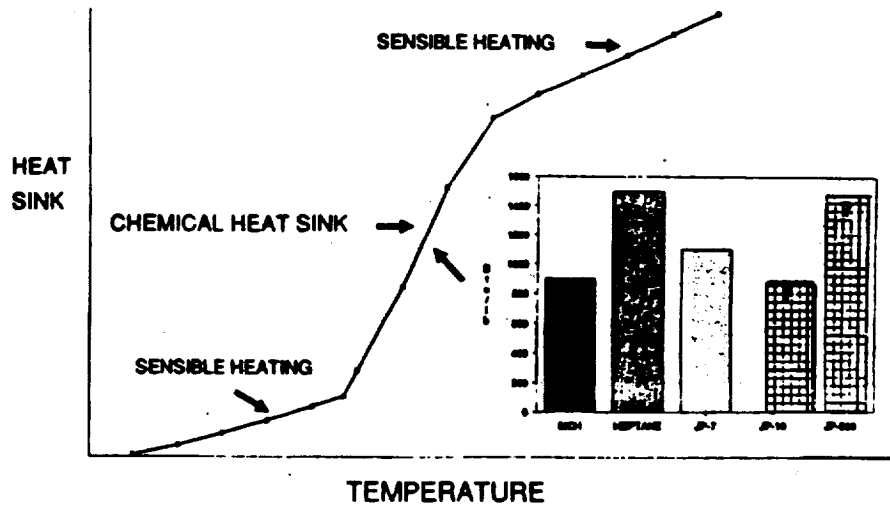

COMBINED CYCLE ENGINE APPLICATIONS

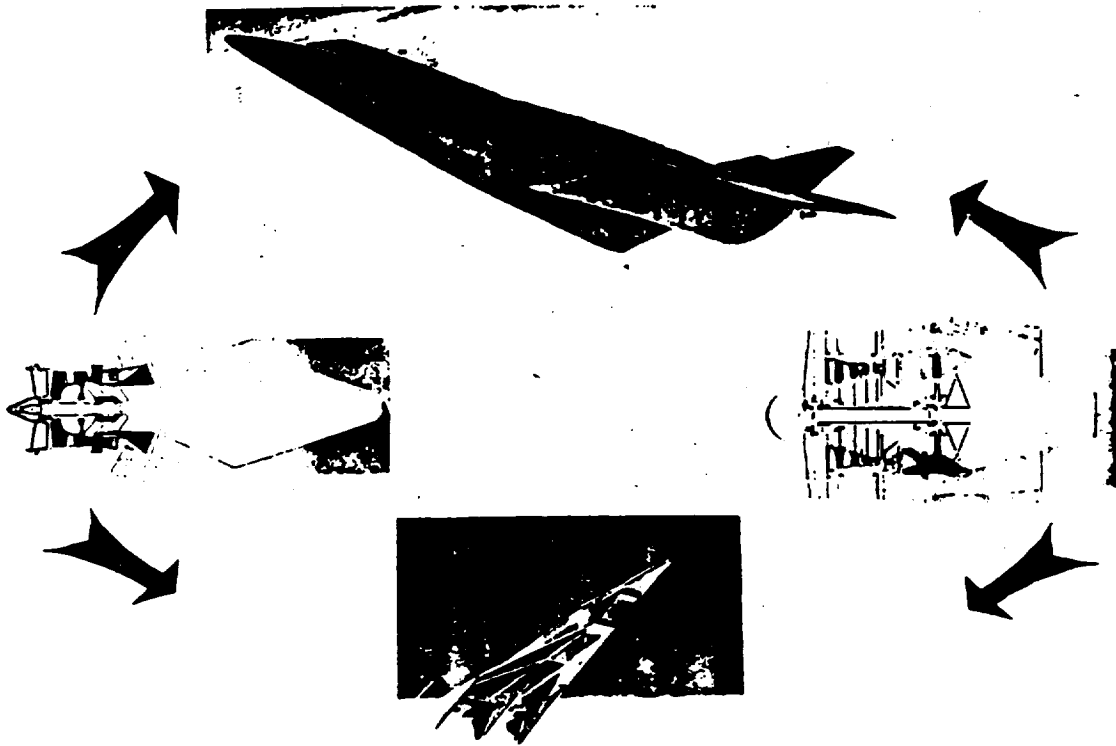

NASA/AF HIGH MACH TURBINE ENGINE

- OBJECTIVE: TO CONDUCT DESIGN STUDIES AND CRITICAL COMPONENT EXPERIMENTS OF ADVANCED TURBINE ENGINE SYSTEMS WHICH OPERATE IN THE MACH 4-6 REGIME

- STATUS: TWO (2) CONTRACT AWARDS

NA3-26051 - GENERAL ELECTRIC
NA3-26052 - PRATT & WHITNEY

TECHNICAL WORK BEGINS IN EARLY JUN 90
FIVE (5) YEAR TECHNICAL EFFORTS THRU JUN 95
113,000 MANHOURS OF EFFORT EACH

ORIGINAL PAGE IS
OF POOR QUALITY

CRITICAL ENGINE COMPONENT TECHNOLOGIES

Needed For Both TRJ and ATR Applications

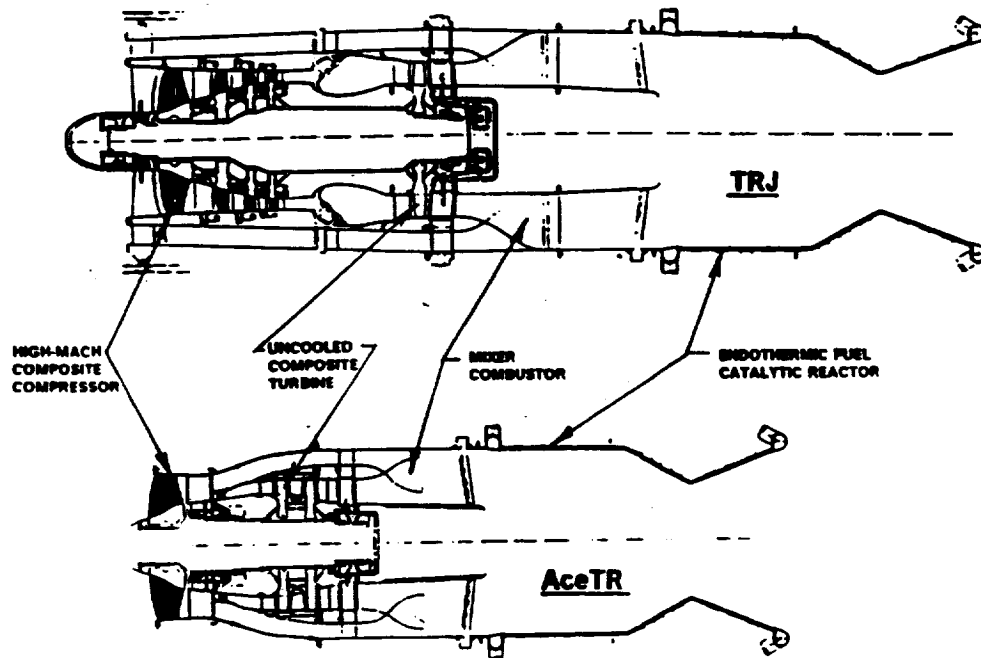

COMBINED CYCLE ENGINES RECENT ACCOMPLISHMENTS

DESIGN STUDIES

- DESIGN STUDIES COMPLETED ON MACH 5.5 TTFRJ & MACH 5.0 AceTR
- CRITICAL COMPONENTS IDENTIFIED
- NASA LANGLEY FUNDED MACH 5 WAVE RIDER USING OVER/UNDER TRJ

TURBORAMJET

- INITIATED MAN RATED HEAT EXCHANGER REACTOR
- INITIATED RAMBURNER FOR DEMONSTRATION IN WL TEST CELL 22

AIR TURBOROCKET

- INNOVATIVE COMPRESSION CONCEPT PERFORMANCE DEMONSTRATED WITH SIMULATED NORPAR 12 FUEL PRODUCTS
- INITIATED DEVELOPMENT OF FUEL COOLED STRUCTURE HEAT EXCHANGER/REACTOR

PSL-4 HYPERSONONIC MODIFICATION

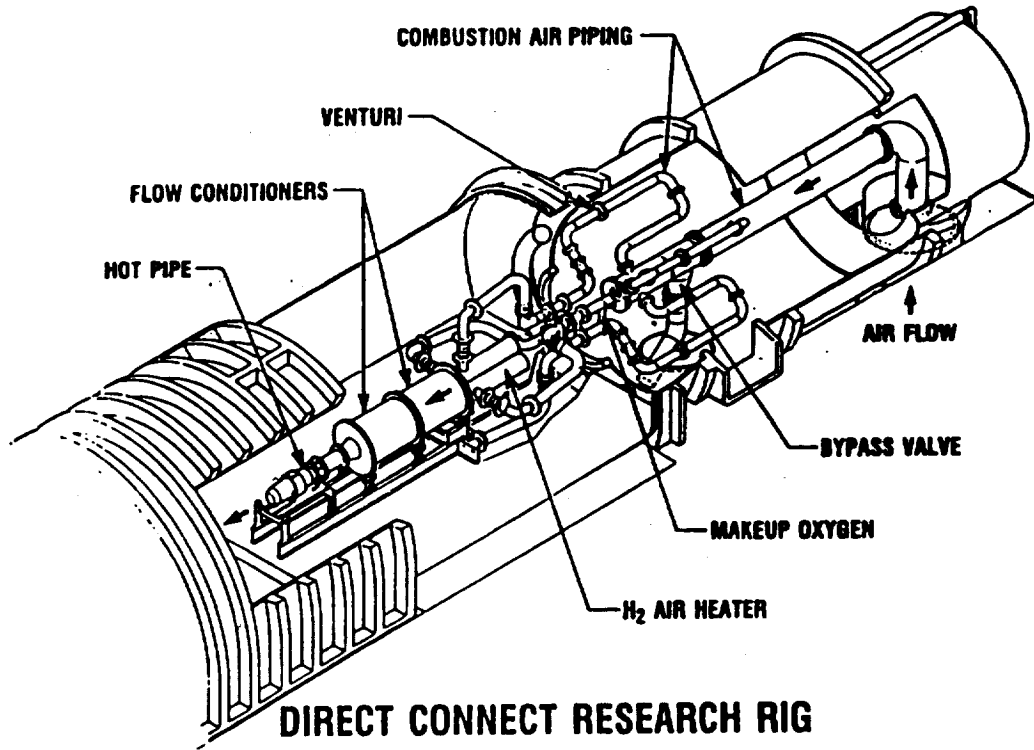

SUPERSONIC FREEJET INSTALLATION

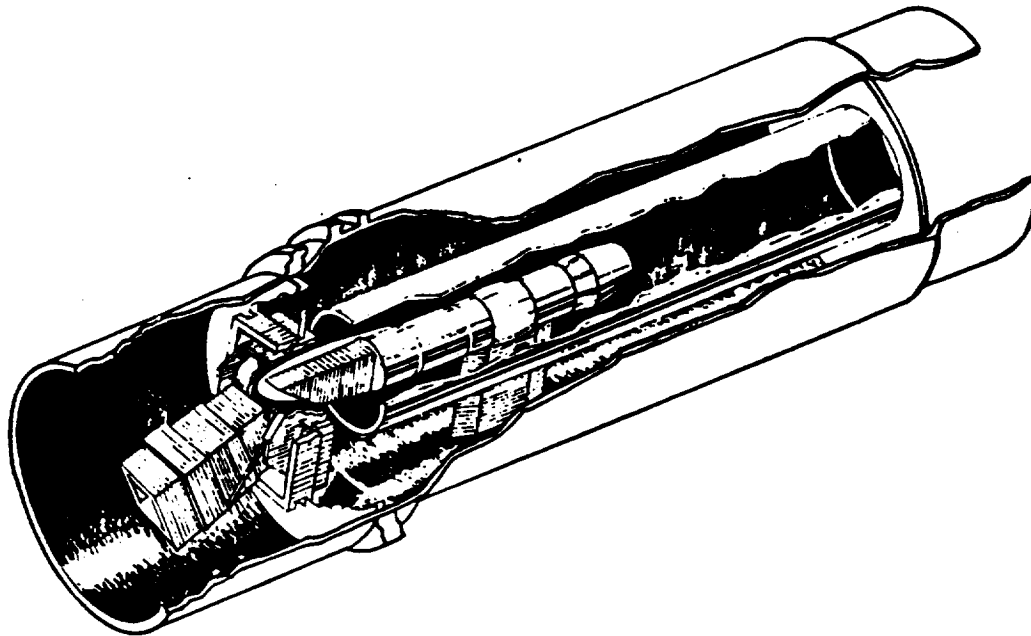

199201252

N 9 2 - 2 1 5 2 4

**AIR AUGMENTED CONVENTIONAL
ROCKET ENGINES**

628254
top.

**Shahram Fahahngi
Rocketdyne Division/Rockwell Int.
Canoga park, CA**

SYNOPSIS

An analytical study was conducted to assess and estimate the level of effectiveness of an ejector/rocket, or rocket engine nozzle after-burning concept for enhancement of a conventional rocket engine. Performance enhancement and thrust augmentation of an ejector/rocket system were evaluated for a National (or Advanced) Launch System (NLS or ALS) type engine, namely the Space Transportation Main Engine (STME), and its effects on the overall vehicle/propulsion system such as payload weight, gross lift-off weight, and propellant weight. The focus was on using a fixed geometry ejector and utilizing the otherwise wasted exhaust excess fuel of rocket engines and burning it with ingested atmospheric air to produce additional thrust. Limited analyses were also performed to determine effect of burning additional injected fuel with the secondary air on thrust augmentation.

Ideal flow analyses based on inviscid flow calculations with complete mixing and combustion of primary and secondary flow within the ejector length, estimated between L/D of 1 to 5, were conducted. The secondary flow was assumed to be choked ($M = 0.9$) at subsonic flight speeds and decelerated to subsonic flow through a normal shock at supersonic flight speeds ($M = 2$). A simple fixed geometry shroud configuration was optimized to operate as an ejector system in the flight speed range of Mach 0 to 2 to augment NLS rocket engine thrust. Parametric studies that were performed resulted in an ejector geometry with secondary inlet area of 80 sq ft. with area ratio of 1.63. This ejector produced substantial ideal thrust augmentation at all flight Mach numbers in the range of 0 to 2 with and without injection of additional fuel. The increased thrust was traded against increased ejector weight and external drag. This resulted in maximum payload increase in excess of 27% with NLS fixed vehicle size, or Gross Lift-Off Weight (GLOW) and propellant weight reduction in excess of 19 & 23% respectively with a constant NLS baseline payload of 120 Klbs. The gain is based on a closely matched flight trajectory for the ejector/rocket system determined for operation without any additional injected fuel. Based on calculated sensitivities to engine parameters, an increase of about 40 sec in I_{sp} would be required for an engine without after-burning to obtain the same (27%) payload increase for NLS.

The performance benefits and increase in payload were estimated assuming that the ejector shroud was jettisoned at flight Mach number of 2. A brief study that was conducted, indicated that the payload increase in excess of 50% would be realized if the ejector was to be used as an extension of the rocket engine nozzle beyond Mach 2.

This substantial improvement in performance (thrust and I_{sp}) indicates that an ejector/rocket propulsion system should be considered as candidate propulsion system for Single-Stage-to-Orbit application. The SSTO configuration greatly improves the launch operability of the boosters by reducing the number of systems and interfaces.

ASSESS EFFECTIVENESS OF ROCKET ENGINE NOZZLE AFTERBURNING CONCEPT

- EJECTOR/ROCKET COMBINED CYCLE ... SUPERSONIC COMBUSTION
- DEFINE FIXED EJECTOR GEOMETRY FOR MACH 0 TO 2
- DETERMINE EJECTOR THRUST & ALS ENGINE THRUST AUGMENTATION
- ESTIMATE SIZE AND WEIGHT
- IMPACT OF EJECTOR DESIGN ON OVERALL MISSION PERFORMANCE .. ALS TYPE VEHICLE & TRAJECTORY

ROCKET ENGINE NOZZLE AFTER-BURNING CONCEPT

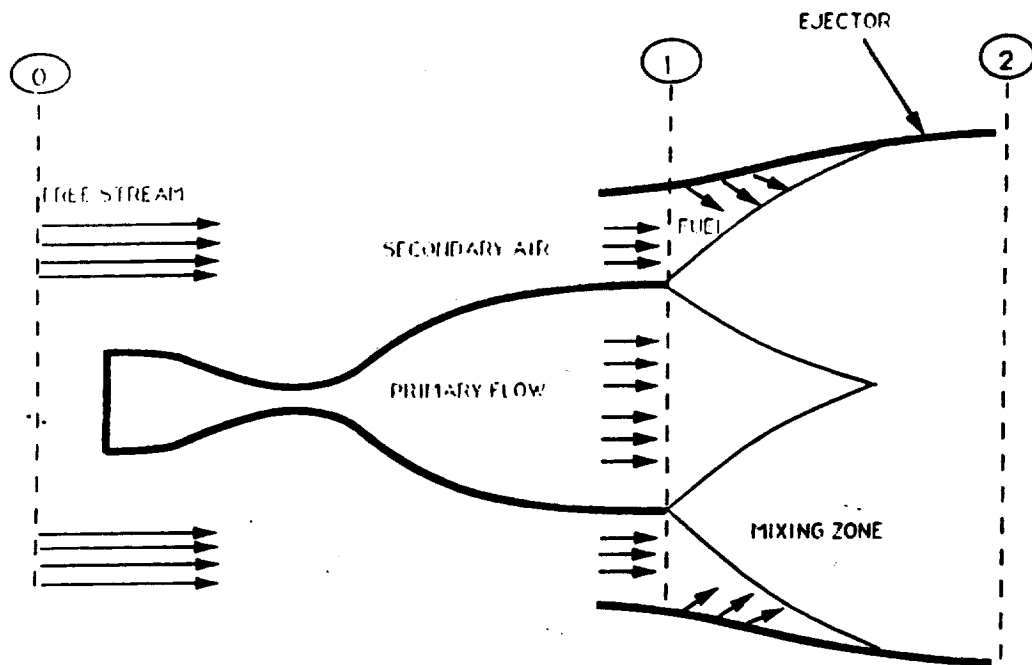

AUGMENTATION DETERMINED BY 1-D INTEGRAL METHOD

- COMPLETE MIXING WITH EQUILIBRIUM CHEMISTRY USED FOR THRUST CALCULATIONS
- AUGMENTATION IS BASED ON ASSUMED UNIFORM FLOW WITH NO HEAT, DRAG & VISCOUS, SHOCK(S), DIVERGENCE, AND KINETICS LOSSES
- INLET KINETIC ENERGY LOSSES INCLUDED
- CHOKED SECONDARY FLOW ($M=0.9$) AT SUBSONIC FLIGHT REGIME, AND RAM COMPRESSION TO SUBSONIC INLET FLOW AT FLIGHT $M=2$

Augmentation VS Ejector Area Ratio

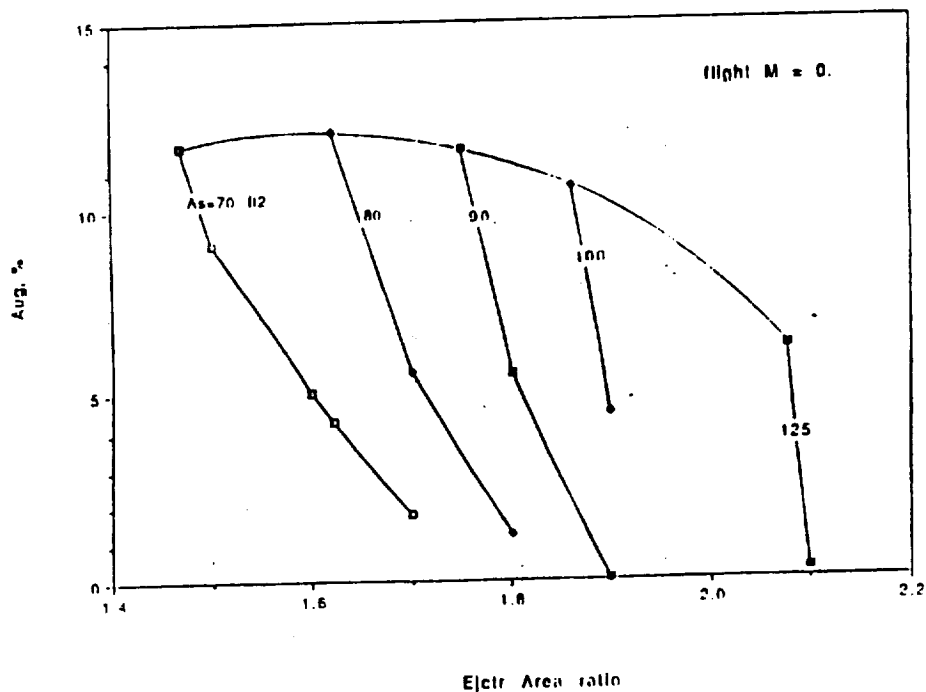

Thrust Augmentation VS Flight Mach

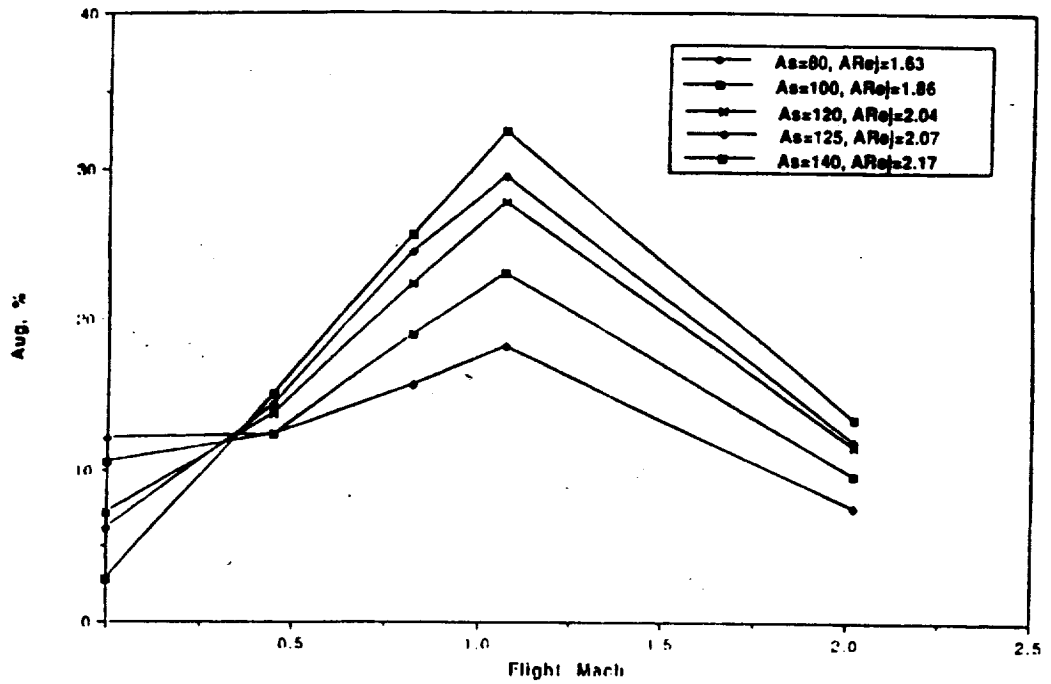

ALS PAYLOAD WITH EJECTORS ON STMEs

7/3 STMEs IN BOOSTER/CORE
ONE CORE ENGINE OUT

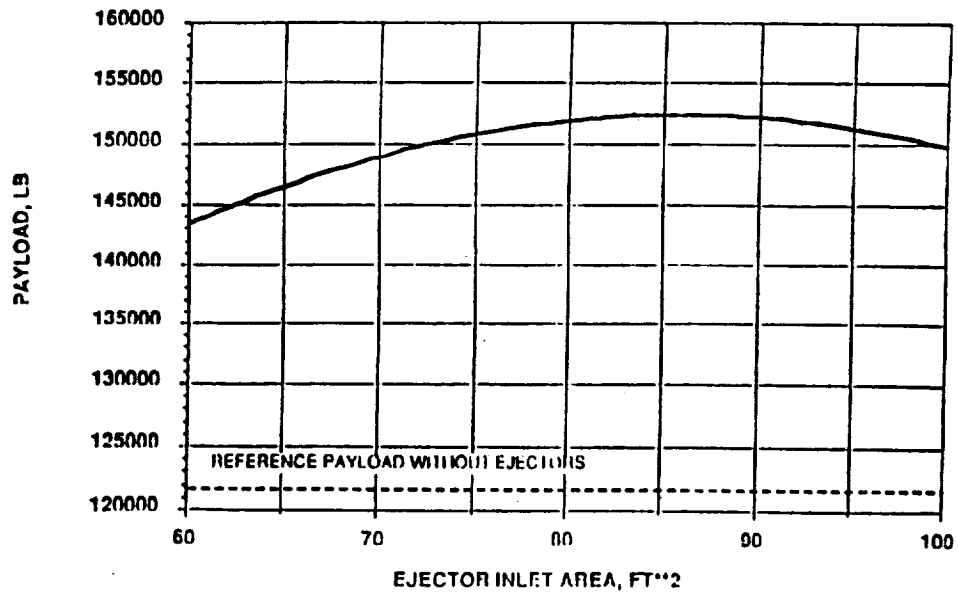

Thrust Aug. Comparison W & W/O Added Fuel

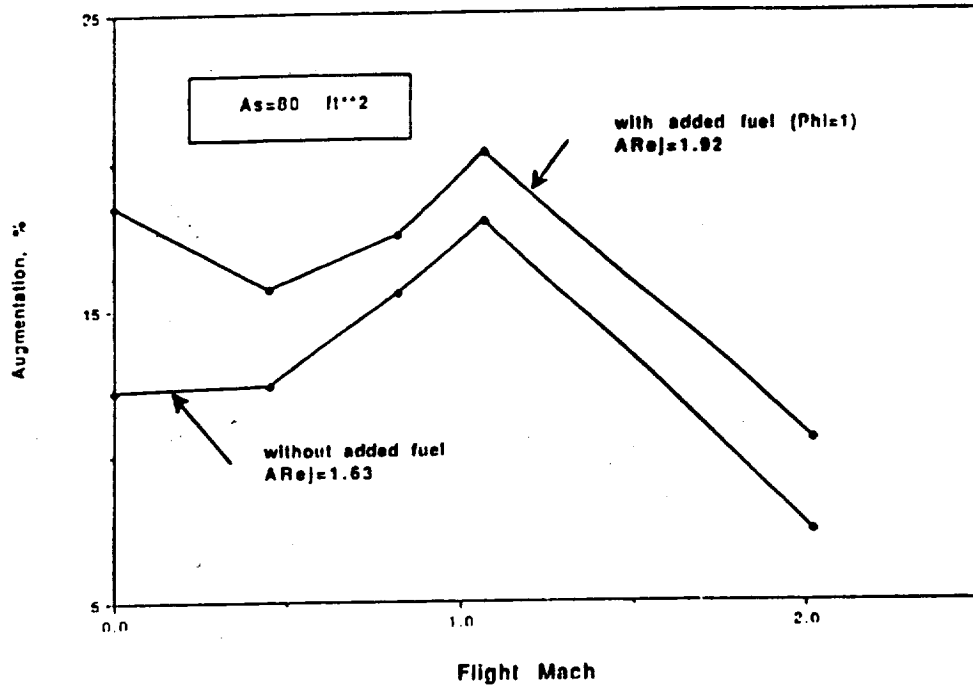

Latest GD Vehicle With & W/O Fuel Addition

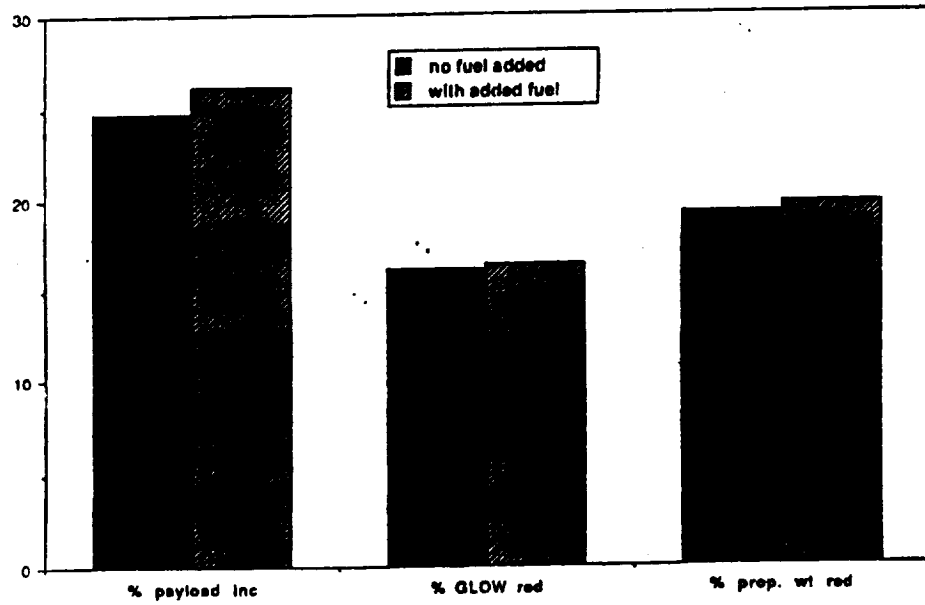

Note: As=80 ft², ARej=1.63, Ref p/L=120klb

First Trajectory Iteration, Increased Gain

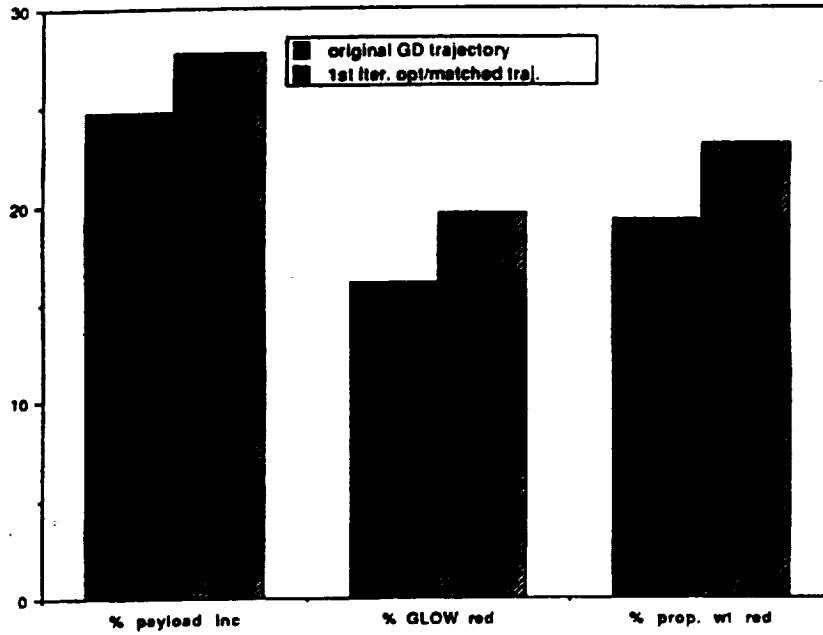

Note: $A_s=80 \text{ ft}^2$, $A_{Re}=1.63$, w/o added fuel, ref. $P/L=120 \text{ kibs}$

Payload Increase vs Ejector Length

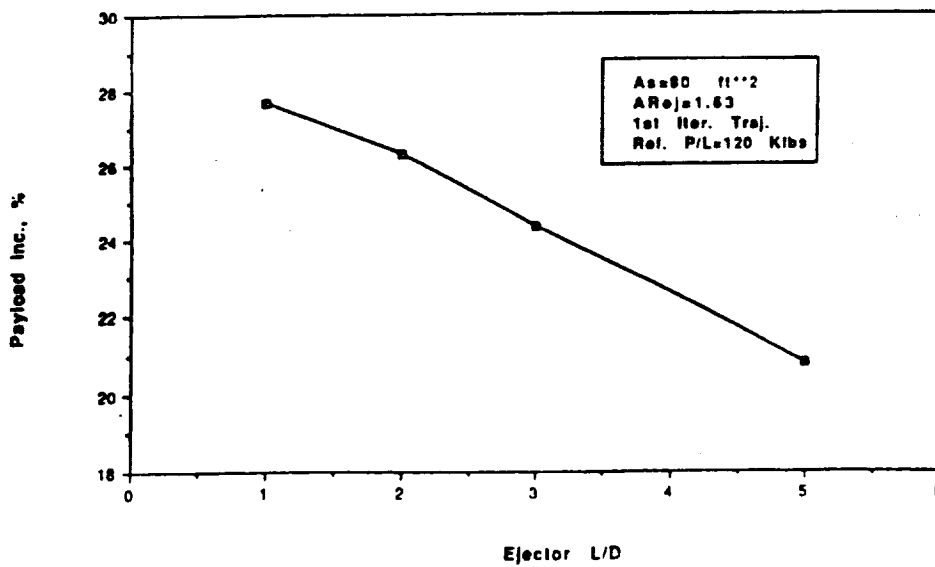

SIGNIFICANT IDEAL THRUST GAIN WITH EJECTOR/ROCKET

- SIGNIFICANT POTENTIAL I_{sp} INCREASE POSSIBLE WITH AIR AUGMENTATION OF CONVENTIONAL ROCKET ENGINES
- FOR BASELINE VEHICLE AND TRAJECTORY
 - In excess of 27% payload increase w/o added fuel
 - 30% payload increase with injection of additional fuel ... higher with optimum geometry/trajectory
- UTILIZATION OF EJECTOR AS NOZZLE EXTENSION COULD INCREASE PAYLOAD IN EXCESS OF 50%
- POSSIBILITY OF ELIMINATING A STAGE OR NUMBER OF ENGINES

EFFORTS REQUIRED TO ADDRESS MAJOR ISSUES

- EFFECT OF MIXING ON AUGMENTATION, USE OF MIXING AIDS ... EJECTOR LENGTH
- INLET FLOW / PUMPING CAPABILITY
- ENGINE/VEHICLE INTEGRATION
- VARIABLE GEOMETRY EJECTOR

BRIEF INTRODUCTION

**R. Rhodes
NASA KSC**

(Paper Not Received in Time for Printing)

N92-21525

LIQUID AIR CYCLE ENGINES
Jerry Rosevear
Kaiser Marquardt
Van Nuys, CA 91406

1492012283

628255

10p.

BASIC LACE

In the late 50's and early 60's Marquardt Company engineers devised a unique propulsion system referred to as LACE - Liquid Air Cycle Engine. (Figure 1). The cycle was predicated on improving the ISP above that of a rocket and be used for reusable space vehicle. You could envision this as an airbreathing rocket. The principle of operation is straight forward. Liquid hydrogen is pumped and is circulated through the condenser and through the precooler and is then used to cool combustion chamber prior to being injected into the combustion chamber. Air enters through the precooler and processed to saturated conditions at the condenser face. The air is condensed to a liquid and pumped into the combustion chamber. The hydrogen air combust at high pressure and exit through a nozzle to provide thrust. The Basic LACE requires an equivalence ratio of 7 to 8 and results in a specific impulse of about 1000 seconds. The Isp is low even though the air is free because of constraints of the heat exchangers and the liquid hydrogen heat capacity.

IMPROVED LACE

Operating the cycle near stoichiometric would lead to large improvements in the specific impulse. System mission requirements consisting of broad Mach number and altitude operability presented design challenges for the propulsion engineers. A single cycle is incapable of meeting these requirements. The Basic LACE was then expanded upon and advanced Liquid Air Cycles were defined. The evolution of Advanced Combined engine cycles is shown in Figure 2.

Modification to the Basic LACE Cycle are shown in Figure 3. These concepts were evaluated in 1966 for NASA. In a study of Composite Propulsion Systems for Advanced Launch Vehicle Application. Each concept was a step toward improving the specific impulse over a wide operating range, thrust to weight ratio and compact installation. A cryojet engine, one of those shown on the previous chart was a viable advanced thermodynamic cycle that offered high specific impulse, high thrust to weight ratios and an increased Mach number capability and increased complexity. Figure 4 shows two variations of the cryojet. The cryojets operational equivalence ratio varies from 1.5 to 1.0 for Mach number operation from 0 to 4. Specific impulses vary from 3,000 to 4,000 seconds and can have high thrust to weight ratios because of the very small relative size of the turbomachinery required in the liquid jet. An example of the speed range and specific impulse for the cryojet operation is shown in Figure 5 and Figure 5 also shows relationship with other propulsion phases that comprise a multi-mode engine. The cryojet makes use of many key technologies to improve cycle performance.

Key Technologies

1. Heat exchanger design and fabrication techniques
2. Liquid Hydrogen handling to achieve greatest heat sink capacities,
3. Air decontamination to prevent heat exchanger fouling

Heat Exchanger Design Heat exchanger designs have progressed a long way since the LACE concept originated. Heat exchanger matrices originally evaluated were tube bundles, plate and fin, and finned tube bundles. Heat exchangers were designed, fabricated and tested. Performance of various matrices were defined analytically and experimentally. Bare tube matrices were found to provide advantages for performance, weight and compact volume. System tests also provided insight to design. For precoolers, vertical bare tubes are preferred especially in the aft portion of the unit. Under some conditions the condensing front moves into the precooler and with bare tubes the liquid can run off the tubes. Fin tubes trapped the condensed liquid and freezing occurred. Bare tubes are also preferred in the condenser and tubes oriented in a vertical direction provides better condensing coefficient characteristics. At low condensing pressures tubes in the vertical position allows liquid to run down the tubes and wash off slush as freezing conditions are approached. Figure 6 presents a concept for fabrication that has advantages for fabrication, leak checking and assembly and provides a light weight configuration. Tube rows are fabricated then assembled to form a unit.

Today design concepts are continuing to be formulated that will considerably improve fabrication techniques and improve performance. Analytical results indicate that the volume of some units could be reduced by 50 percent with a significant weight reduction. Many materials are also being evaluated to reduce weight such as aluminum, thin wall stainless steel, beryllium.

Liquid Hydrogen Handling. The efficient operation of the heat exchanger system requires achieving the greatest heat sink capacities. The use of catalysts to speed conversion of para hydrogen to ortho hydrogen is required. The heat of conversion can be used to augment the amount of liquid air produced with smaller heat exchanger units. The metal ruthenium deposited on aluminum oxide has proven to be an efficient catalyst for the conversion process. The catalyst could be contained in a bed or within the tubes and manifolds of the heat exchanger. The problem is to get sufficient surface area for the conversion. Between 5 and 7 lbs of catalyst is required per lb per second of hydrogen flow rate for a 90% conversion. Catalyst evaluations were done in the 60's and are continuing today. Figure 7 shows the effects of conversion. Subcooled and Slush Hydrogen provides a significant improvement in

the system performance if the engine can be operated at equivalence ratios near 1.0. By recirculating the excess hydrogen back into a subcooled or slush hydrogen tank this can improve the Isp of the propulsion system. Slush hydrogen has two advantages. The higher density of the solid can increase the tank capacity or reduce volume of the tank and increase the low temperature heat sink. The slush provides 15 to 18 percent increase in the density and about a 20 increase in the low temperature heat sink. By the use of slush hydrogen in the tank we can also increase our hydrogen equivalence ratio from a 7.3 to 12.1 in the heat exchangers and reduce the volume in the condenser by as much as 15 percent and in the precooler by as much as 50 percent for a significant volume and weight reduction. Figure 8 shows effects of recycling and slush hydrogen. Another method of improving refrigerant effect of hydrogen as a coolant is hydrogen turbine expanders. Expanding the hydrogen reduces the temperature and can be useful in a cascading condenser system as in the liquid cryojet. An example of the use of turbine expanders is shown in figure 9. A problem associated with the LACE types propulsion systems is heat exchanger fouling due to water vapor in the atmosphere. This problem usually occurs at low altitudes, 0 to about 20,000 ft. These altitude conditions have a specific humidity range from 0.03 lbs of water per lb of air down to 0.001. As moisture is ingested into the heat exchangers, ice forms on the tubes causing an increase in pressure drop and a decrease in heat transfer. The ice can continue to build up until flow cannot be maintained. Considerable progress has been made to alleviate the affects of water vapor. Some of the alleviation techniques investigated are shown below:

- | | |
|--------------------------------------|-------------------------------------|
| 1. Tube Coatings | 8. Snow Formation |
| 2. Surface Finishes | 9. Cyclic De-icing |
| 3. Ultrasonic Tube Vibrations | 10. Liquid Air Injection |
| 4. Airstream Vibrations | 11. Ice Collection |
| 5. Pulsed Coolant Flow | 12. Glycol Injection |
| 6. Thermal Pressure Tube Distortions | 13. Liquid Condensation with Glycol |
| 7. Rotary Heat Exchangers | |

Glycol Injection was demonstrated as the most feasible for preventing icing on heat exchangers. Air pressure drop across the heat exchangers and heat transfer coefficient were selected as parameters to show effectiveness of decontamination. Figure 10 shows effects of water vapor on heat exchanger pressure drop. This was caused by water vapor freezing on the tubes. Also shown on figure are results with the prevention system of spraying glycol into the airstream to mix with the water vapor and reduce freezing point. The water vapor glycol mixture was then removed by a separator prior to going into the system precooler. This system was demonstrated in the 1960's. A requirement to fly the propulsion system on hot day atmospheric conditions with specific

humidities up to 0.030 lbs of water vapor to lbs of air required a modification to the glycol injection system. This system reduced the air specific humidity to 0.001 lbs/lb consistent with previous system tests. The system has demonstrated capability to prevent heat exchanger fouling for air specific humidities up to 0.043 lbs H₂/lb air with water injections up to 0.2 pps to simulate rain storms and ingested runway water. Cyclic glycol injection has been demonstrated as a technique to reduce glycol consumption and weight volume.

This brief report of the LACE (Liquid Air Cycle Engine) has defined LACE engines with the technologies existing. Technology needs to be extended in areas of design and fabrication of heat exchangers to improve reliability with weight and volume reductions. Catalysts need to improve so that conversation can be achieved with lower quantities and lower volumes. Packaging studies need to be investigated both analytically and experimentally. Recycling with slush hydrogen needs further evaluation with experimental testing.

BASIC LACE (LIQUID AIR CYCLE ENGINE) SCHEMATIC

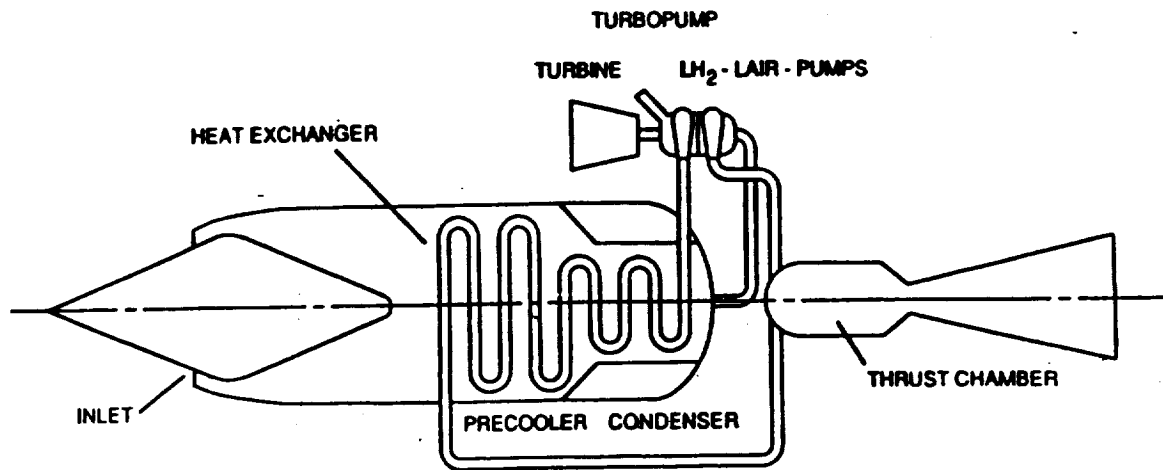

Figure 1

EVOLUTION OF ADVANCED PROPULSION SYSTEMS

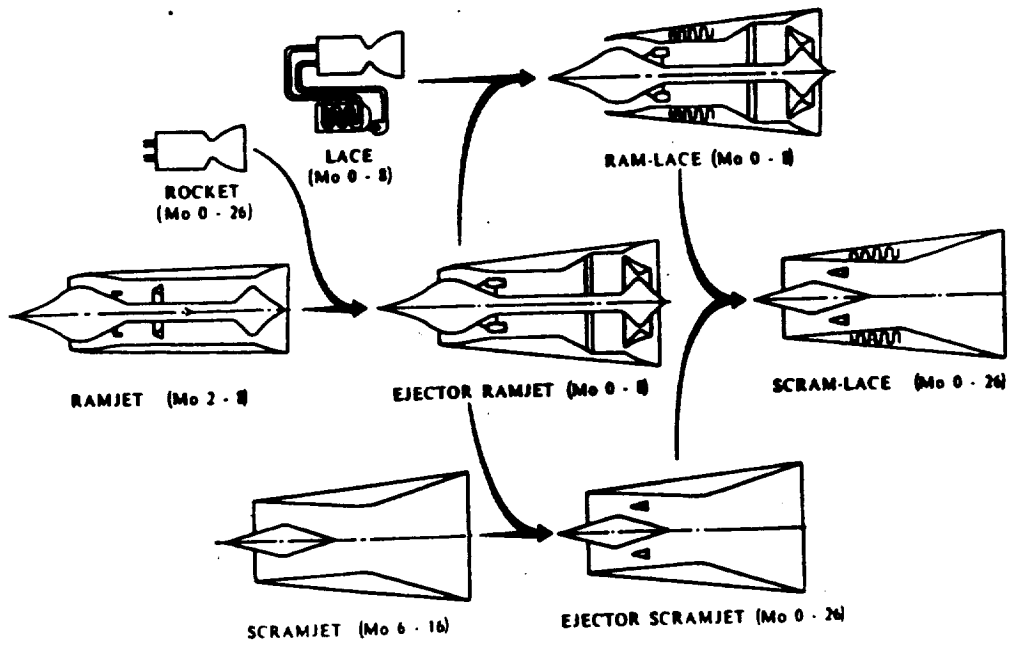
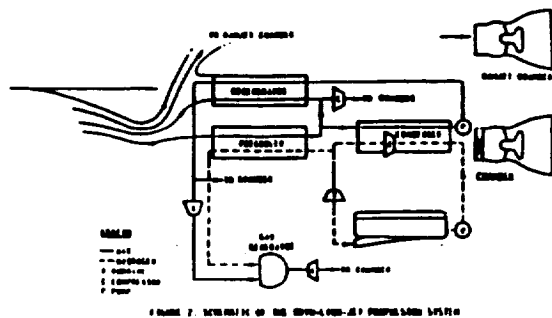

Figure 2

ADVANCED LIQUID AIR CYCLE ENGINES

CRYO JETS



LIQUIDIFICATION OF AIR

OPERATIONAL EQUIVALENCE RATIO = 1.5 TO 1.0
 MACH 0 - 4
 SPECIFIC IMPULSE 3000 - 4000 SECONDS
 HIGH THRUST TO WEIGHT RATION
 SMALL RELATIVE SIZE OF TURBOMACHINERY
 CONDENSER - CASCADING SYSTEM WITH EXPANSION TURBINE TO REDUCE TEMPERATURE OF H₂

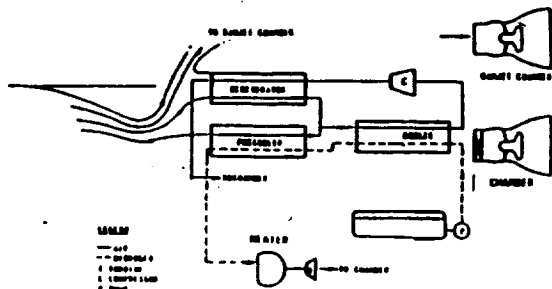

ELIMINATED LIQUIDIFICATION OF AIR

SINGLE FLOW PATH
 CYCLE LIMITED TO RELATIVELY LOW CHAMBER PRESSURES
 SPECIFIC IMPULSE 3000 - 4000 SECONDS
 LOWER THRUST TO WEIGHT RATIO THAN LIQUID.

Figure 4

LACE CYCLES EVALUATED FOR ADVANCED VEHICLE APPLICATIONS 1966

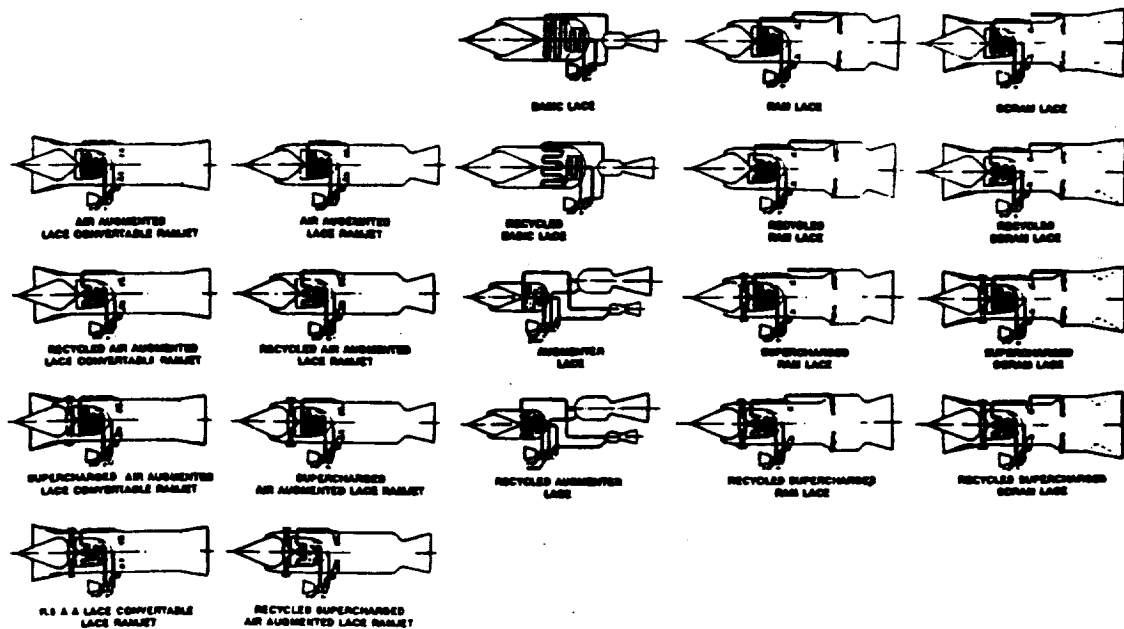

Figure 3

SPECIFIC IMPULSE VERSUS VELOCITY

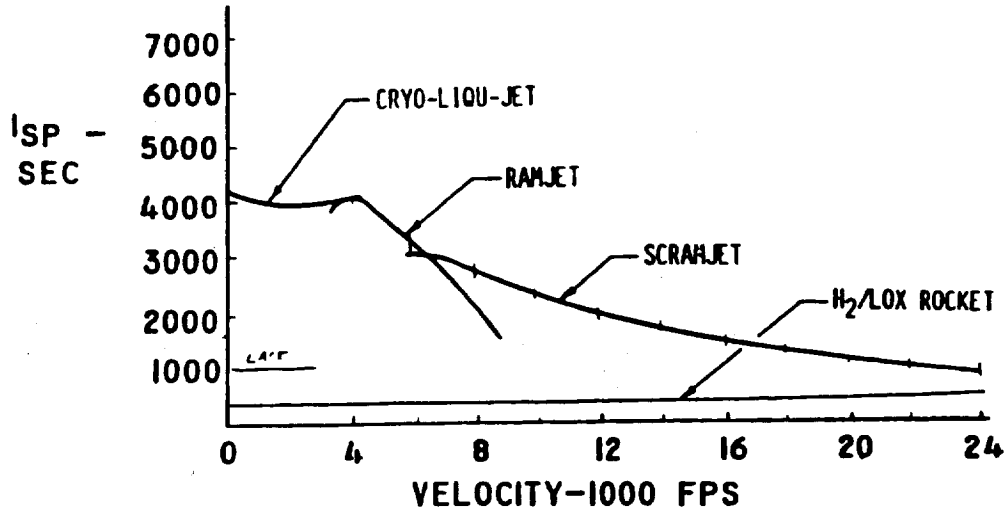

Figure 5

KEY TECHNOLOGIES HEAT EXCHANGER DESIGN & FABRICATION

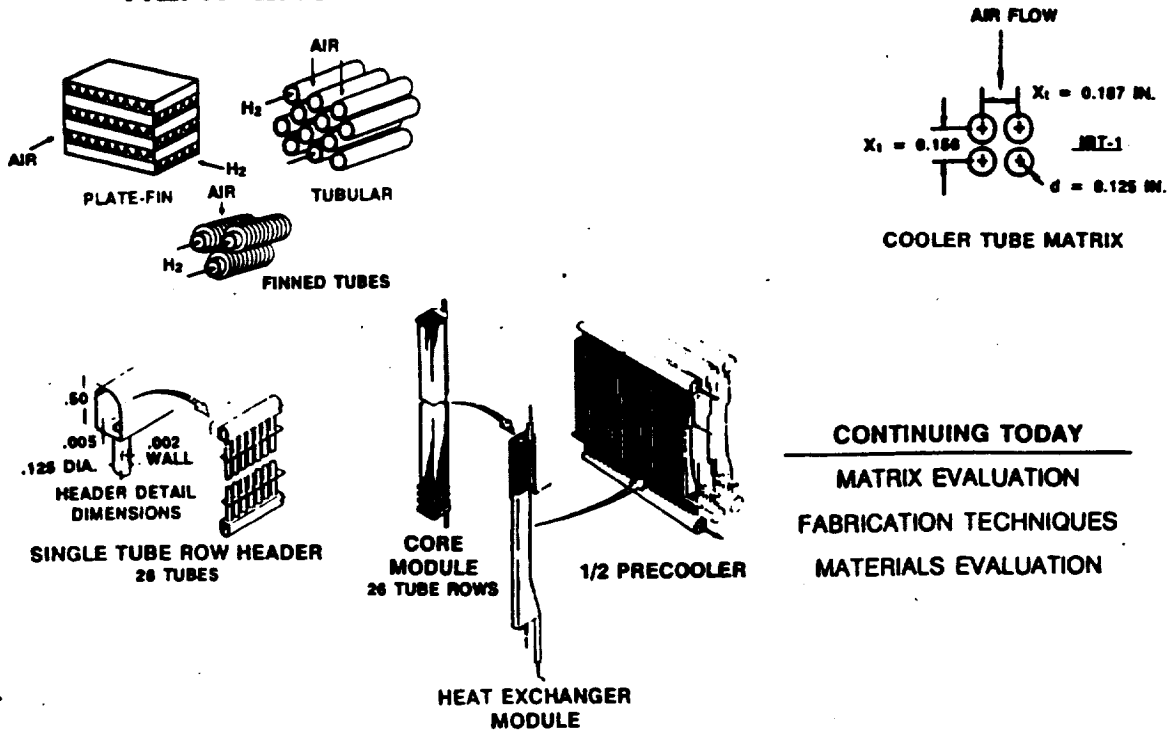

Figure 6

KEY TECHNOLOGIES LIQUID HYDROGEN HANDLING PARA/ORTHO CONVERSION

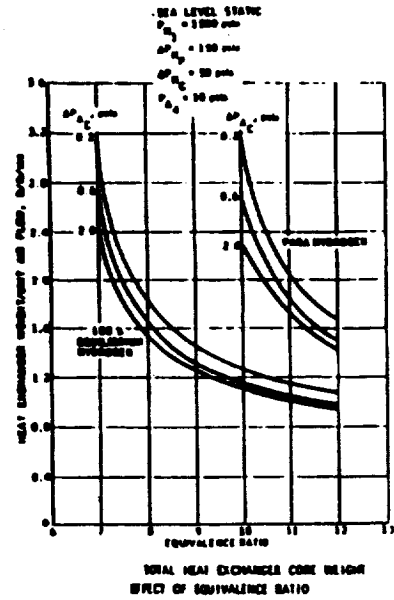
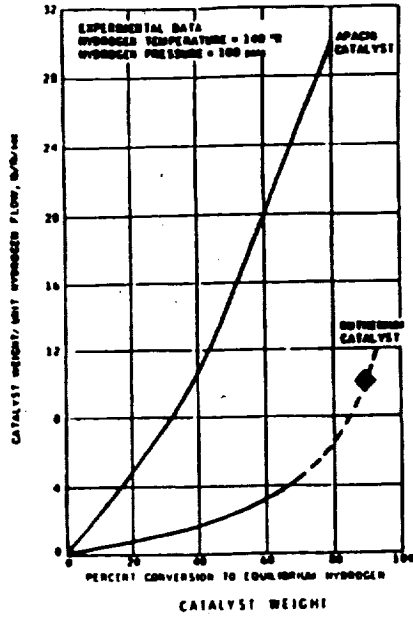

Figure 7

KEY TECHNOLOGIES SLUSH HYDROGEN

SLUSH HYDROGEN SCHEMATIC

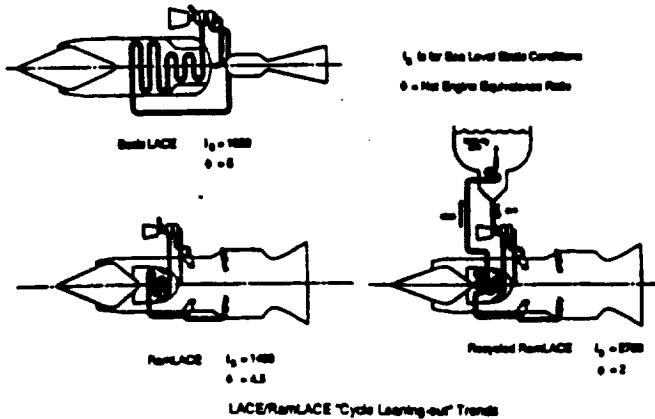
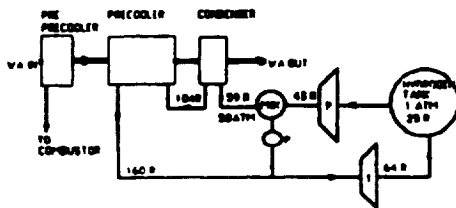

Figure 8

ADVANTAGES OF SLUSH HYDROGEN

HYDROGEN TANK CAPACITY GREATER DUE TO HIGHER DENSITY OF THE SOLID --- 10 PERCENT --- APPROXIMATELY THE SAME AMOUNT OF LIQUID IN THE TANK AFTER AS IF ORIGINALLY LOADED WITH JUST LIQUID

HEAT EXCHANGER SIZE AND WEIGHT 15-50 PERCENT LOWER

	PARA/ORTHO	PARA/SLUSH
CONDENSER		
HYDROGEN DENSITY RATIO %	7.3	12.1
VOLUME (ft ³)	6420	3700
PERCENT REDUCTION		43
PRE-COOLER		
HYDROGEN DENSITY RATIO %	7.3	12.1
VOLUME (ft ³)	16304	8800
PERCENT REDUCTION		46
ENGINE OPERATING %	15	1.0

KEY TECHNOLOGIES TURBO MACHINERY

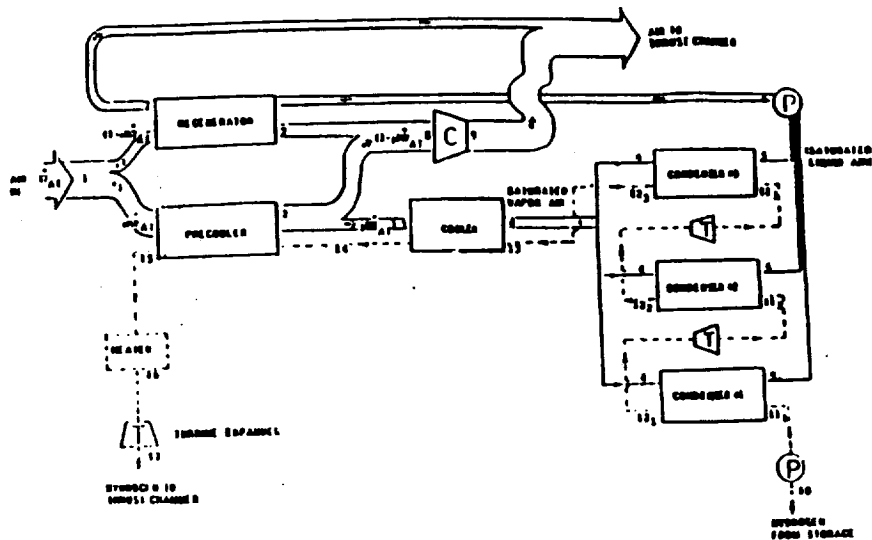

4. SCHEMATIC OF THE CRYO-LIQUID CYCLE

Figure 9

SUCCESSFUL CONTAMINATION ALLEVIATION TECHNIQUES

- ALLEVIATION TECHNIQUES INVESTIGATED
1. TUBE COATINGS
 2. SURFACE FINISHES
 3. ULTRASONIC TUBE VIBRATIONS
 4. AIRSTREAM VIBRATIONS
 5. PULSED COOLANT FLOW
 6. THERMAL/PRESSURE TUBE DISTORTIONS
 7. ROTARY HEAT EXCHANGERS WITH SUBLIMATION
 8. SNOW FORMATION
 9. CYCLIC DE-ICING
 10. LIQUID AIR INJECTION
 11. ICE COLLECTION
 12. GLYCOL INJECTION
 13. LIQUID CONDENSATION WITH GLYCOL

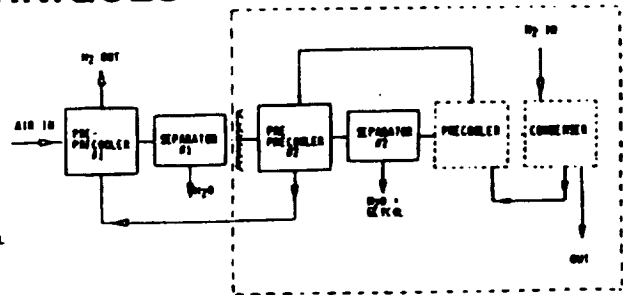

PRESSURE DROP CHARACTERISTICS

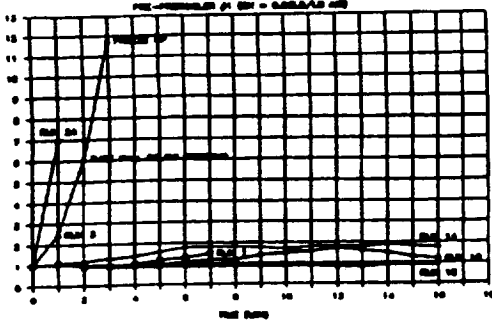

PRESSURE DROP CHARACTERISTICS

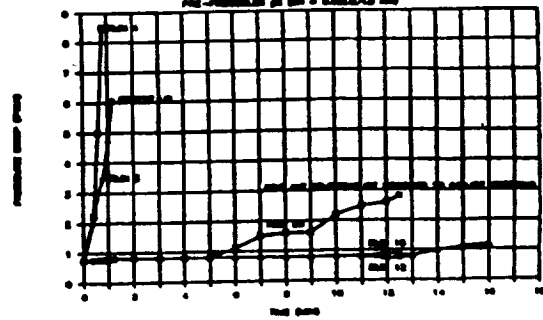

Figure 10

199201
625257
20p.

N 9 2 - 2 1 5 2 6

CRYOGENIC HYDROGEN-INDUCED AIR-LIQUEFACTION TECHNOLOGIES FOR COMBINED-CYCLE PROPULSION APPLICATIONS

William J.D. Escher
Transportation and Platforms Division
NASA Headquarters
Washington, DC

ABSTRACT

Extensively utilizing a special advanced airbreathing propulsion archives database, as well as direct contacts with individuals who were active in the field in previous years, a technical assessment of the realization of cryogenic hydrogen-induced air liquefaction technologies in a prospective onboard aerospace vehicle process setting, was performed and documented. This paper derives from, and summarizes this work specifically for an RBCC Workshop audience.

It reviews technical findings relating the status of air-liquefaction technologies, both as singular technical areas, and also as that of a "cluster" of collateral technological facets including: compact lightweight cryogenic heat-exchangers; heat-exchanger atmospheric-constituent fouling alleviation measures; para/ortho-hydrogen shift-conversion catalysts; cryogenic air-compressors and liquid air pumps; hydrogen recycling using slush hydrogen as heat-sink; liquid hydrogen/liquid air rocket-type combustion devices; and technically-related engine concepts.

With the advent of cryogenic liquid hydrogen as an operational aerospace propulsion fuel, roughly in the mid-1950's, propulsion researchers devised a unique propulsion cycle predicated on the unique cryogenic heat-sink qualities of this fuel, the Liquid Air Cycle Engine (LACE). This rocket-like airbreathing engine utilized its liquid hydrogen fuel flow to process atmospheric air, taken aboard the vehicle by a special air inlet, through a compact heat exchanger into its cryogenic liquid form. Using the thus produced liquid air (LAIR) in lieu of tanked liquid oxygen, this engine offered a specific impulse performance level more than double that of a comparable conventional rocket engine.

But, very significantly, this seemingly high level of performance is very substantially below that of an *optimal* hydrogen-fueled airbreathing engine, say a turbojet-cycle engine (which, however, would tend to be much heavier and more complex). The root cause for this shortfall in performance is mainly a technically daunting constraint associated with the basic hydrogen-induced air-liquefaction process: in Basic LACE *much* more than a unity equivalence ratio (stoichiometric) amount of liquid hydrogen is required to liquefy the air, typically a very fuel-rich factor-of-eight more.

Much of the subsequent technology development work in this field was dedicated to various innovative schemes to get around this intrinsic cycle limitation. Discussion of these technical approaches, in fact, provides a basic "theme" for the paper. Several propulsion system concepts, utilizing these advanced technologies (for performance improvement) are described. One of these,

"SuperLACE" was purported to achieve full obviation of this over-richness constraint by synergistically integrating a combination of those technical approaches to be described. SuperLACE was thereby offered as a candidate for integration into the aerospaceplane concepts being considered for advanced U.S. Air Force orbital missions at that time (early 1960's).

INTRODUCTION

This presentation summarizes the findings of a 1986 technology survey of work conducted in the U.S., mostly in the 1960's, related to "aerospaceplane" propulsion concepts of that time-period (Reference 1). This survey focused on numerous technological facets of in-flight/onboard air-cooling and liquefaction processes using liquid hydrogen fuel as the coolant in advanced concept Earth-to-orbit space transport vehicles. The present short paper summarizes this work as a tutorial contribution to the host Rocket-Based Combined-Cycle Workshop (please see Reference 2 or 3 for the fully developed technical paper versions from which the present short-form was developed).

TECHNICAL BACKGROUND

Basic Liquid Air Cycle Engine (Basic LACE)

The simplified schematic diagram of Figure 1 present the essential technical features of the original Liquid Air Cycle Engine, or LACE system, a concept dating to about the late 1950's originated by researchers at (then) The Marquardt Corporation. It is perhaps instructive to view Basic LACE as a true "airbreathing rocket" since the thrust chamber and turbopump subsystems are quite equivalent to those in used in liquid-rocket propulsion systems. What must now be added, of course, is an air-induction subsystem (inlet) and the cryogenic-hydrogen cooled air-liquefaction heat exchanger, which is required to convert ambient-condition air to its pumpable liquid form. The operation of the cycle can be inferred from the schematic presentation.

Quite important to note, with the two fluids involved (hydrogen and air) in a conventional heat-exchange process, it is not possible to operate Basic LACE at, or even near the normally desired *stoichiometric* (chemically correct) air/fuel ratio of about 34:1 by mass. Consequently, the cycle is operated very fuel-rich, i.e., in a highly overfueled operation. Even so, the sea-level static (SLS) specific impulse -- calculated on propellant flow from the vehicle tankage (the air is not counted) -- is of the order of 1000 seconds, almost triple that of an equivalent hydrogen/oxygen rocket (i.e., same chamber pressure, O/F of 5 - 6, sea-level backpressure).

Since operating the cycle more nearly stoichiometrically would lead to large gains in specific impulse (the order of 6000 seconds seems technically achievable near stoichiometric conditions), a series of follow-on focused efforts were targeted toward "leaning out the cycle", i.e., sharply reduce its inherent fuel-richness. Such derivative concepts as SuperLACE, NuLACE and ScramLACE ultimately were developed in the course of time, which explains why the modifier "Basic" is appended to the progenitor cycle, LACE. The engineering techniques evolved for this purpose constitute much of the technology development activities of the intervening period, as are sketched out below (and provided in further detail in References 1-3).

A Set of Inter-Related Technologies

With the fundamental cryogenic hydrogen-induced air liquefaction process conducted via a conventional heat exchanger (as shown in Figure 1) as a "technological centerpiece", a set or

"cluster" of adjunct technologies and system issues can instructively be considered. These are called out in a technically interrelated fashion in Figure 2. Several of these technical topics are directly associated with the cycle leaning-out strategy described above, e.g., para/ortho hydrogen shift-conversion catalysts, turbine expanders, and cryogenic air compressors. Some of these technologies address heat-exchanger interfaced adjunct devices and processes.

Still others of these technologies relate to operational considerations, for example avoidance of heat-exchanger fouling by atmospheric constituents, notably water vapor/droplet icing. Finally, innovative engine system concepts have been synthesized which encompass novel cycles and operating modes which go well beyond the air-liquefaction process itself (e.g., the family of Air Collection and Enrichment Systems, ACES). Several key items listed in Figure 2 will be touched upon below. It is noted that ACES, while covered in References 1-3, is not included in this shortened version presentation (i.e., of Reference 3).

LIGHTWEIGHT COMPACT CRYOGENIC HEAT EXCHANGERS

Physical Description and Operation

The simplified flow schematic of Figure 3 presents the thermodynamic essence of the compact cryogenic heat exchanger design typically considered for air-liquefaction systems in the 1960's, and relates the principal parameters of interest. A 2-step precooler/condenser configuration is usually considered in which different geometry and materials of construction may be used in each heat exchanger component. The airflow and hydrogen-coolant passages are generally arranged in a counterflow manner. The pressure and, particularly, the temperature profile of the two fluids in the direction of flow are of controlling interest.

The fundamental heat-exchanger stoichiometry problem discussed above (leading, as noted, to a situation of excessive fuel-richness) is directly related to temperature-profile effects. Specifically, a "pinch temperature" heat-transfer limiting condition occurs in the early stages of the air-condensing process, i.e., at the post-precooler "front" of the condenser unit. Here a minimum driving temperature difference between the condensing air and the warming-up hydrogen is to be established (usually of the order of 5 to 10 K), consistent with balancing heat-exchanger surface area requirements (weight, size) with the achievement of overall heat exchanger performance.

Figure 4 reflects the physical design makeup of typically selected heat-exchanger matrices, reflecting here both plate/fin and tube-in-shell configurations; the latter configuration was mainly focused upon in this work. Both bare-tube and finned-tube arrangements were investigated in test heat exchangers such as that layed out flow-wise as shown in Figure 5. Aluminum alloy and stainless steel thin-walled, small diameter tubes were focused upon in the early work conducted for the U.S. Air Force by The Marquardt Corporation (now Kaiser Marquardt) and Garrett AiResearch (now encompassed by Allied Signal). Small hydrogen passages were dictated by the need to achieve high specific surface areas (square inches per cubic inches). Tube diameters of one-eighth inches (about 3 mm) with wall thicknesses of 0.1 to 0.3 mm (i.e., as thin as four mils -- 0.004 in) were employed in this exploratory testing work.

Early Subscale Experimental Test Hardware

Such small-scale heat exchanger modules of the type just described were operationally tested in a cryogenic environment both as components (left-hand sketch of Figure 6) and as integrated air-liquefaction subsystems, sometimes connected with air/hydrogen combustors (right-hand sketch) at Marquardt's Saugas field laboratory facility in Southern California. The heat-exchanger

sections constructed by AiResearch were encased in sealed vacuum-insulated ducting, within which the hydrogen and airflow streams were controlled as diagrammed.

When such tests were conducted using ambient air, containing water vapor, rather than dry facility-supplied air, icing problems were met. In some cases the heat-exchange surfaces became sufficiently fouled with ice, sometimes in a matter of minutes or so, to terminate the test run. Thus, atmospheric-constituent (argon and carbon dioxide were also potential foulants) antifouling measures became, and remain today, a subject of high interest, but not one to be further discussed here. Suffice it to say that numerous alleviation approaches have been proposed, and several successfully tested.

This small-scale experimental research and demonstration effort culminated with hot-fire operation for several minutes duration of the Basic Lase engine using a square 4 x 4 in cooled combustor. Of possible interest to the reader is the 20-minute film report covering this work presented by Marquardt researchers before the Institute of Aeronautical Sciences in 1961 (Reference 4).

INCREASING THE REFRIGERATIVE EFFECT OF HYDROGEN AS COOLANT

Hydrogen Turbine Expanders and Cryogenic Air Compressors

One approach for enhancing hydrogen's refrigerative effect is to extract enthalpy from the hydrogen by causing it to perform work, e.g., by flowing it through a turbine expander. At the cost of a measurable pressure drop, the temperature level of the hydrogen can be significantly reduced, thus allowing it to liquefy more air than otherwise. A distinct advantage of the turbine-expander approach is the resulting shaftpower which can be used productively to drive pumps, compressors and other auxiliary devices.

One device which might be so-driven is a cryogenic air compressor as used in both air-liquefaction based systems, but also in systems referred to as "cryojets", in which air is cooled but not liquefied. Here, compressing the very cold gaseous air (vs. ambient temperature air) to combustor entrance conditions requires a very much smaller, simpler and lower-power compressor than would otherwise be the case. Also, the characteristic condenser pinch-temperature constraint discussed earlier can be partially obviated and the cycle thus leaned out to some degree.

Cryogenic air compression can also assist directly in air-liquefaction dependent concepts. In effect, more air can be liquefied once it is compressed because, both the condensing temperature is raised and the latent heat of condensation is reduced. Archival study references reveal that significant attention was given to this approach in which, usually, a hydrogen turbine expander was used to drive the cryogenic compressor.

Para/Ortho Hydrogen Shift Conversion Process (Use of Catalysts)

Continuing to pursue the paper's basic theme of "leaning out the cycle" for performance gains, another leading approach, borrowing from basic cryogenic engineering practice, is the incorporation of para-/ortho-hydrogen shift conversion catalysts into the air/hydrogen heat-exchange process. For this, an elementary understanding of the equilibrium makeup of hydrogen with respect to its two naturally occurring forms. These are discriminated in terms of the diatomic molecule's atomic nuclei spin orientation: *para*-hydrogen, where the spin directions are opposite one another, and *ortho*-hydrogen, where they are in the same direction, or have the same clockwise/counterclockwise sense. Of the two, the presence of ortho-hydrogen, the "higher energy" form is favored by increasing hydrogen bulk temperature. The para/ortho split for

equilibrium hydrogen is shown in Figure 7. Note that at, and above room temperature, the hydrogen is three-fourths ortho-form, the remainder being para-form (this is referred to as "normal" hydrogen).

Conversely, para-form hydrogen is the dominant low-temperature form; liquid hydrogen (at equilibrium) is essentially all para-hydrogen. In the commercial production of liquid hydrogen, the normal-composition ambient temperature feedstock (75/25 ortho-para ratio) is purposely shifted, by catalytic means, to all para-hydrogen during the refrigeration process. Since the ortho-to-para shift is exothermic, this shift requires additional refrigeration energy to be provided in addition to the installation of shift-conversion catalyst in the "coldbox". If this shift reaction were not done, and normal-composition hydrogen were to be produced, it would rapidly (over several hours) spontaneously convert itself to para hydrogen, releasing sufficient heat to boil off the liquid which would then, most likely, be lost as vented gas.

Now, given that liquid hydrogen is delivered as para-hydrogen, and that it is to be productively warmed up in the heat-exchange process with air, an opportunity arises to produce a matching endothermic effect by causing some of the para-hydrogen to convert to the ortho form. The amount would be limited by the equilibrium content as a function of temperature (Figure 7). But this, again, requires a para/ortho shift-conversion catalyst in view of the overly "slow kinetics" of the non-catalyzed self-equilibration process. Quantitatively, the potential refrigerative effect here is about half-again that gained in converting liquid hydrogen to gaseous form at the boiling temperature (i.e., extracting the latent heat of vaporization).

Achieving this shift conversion in a flightweight cryogenic heat exchanger entails added weight (catalyst and support) and otherwise complicates the design. Nevertheless, numerous systems studies have shown that the ortho/para- conversion approach is a desirable way of augmenting hydrogen's refrigeration capability. Consequently, fairly extensive experimental and design investigations have been pursued on this process over the years (e.g., as reported in Reference 1). For example, the platinum-family metal, ruthenium, as deposited on a refractory substrate, has been shown to be a leading candidate for this application.

Subcooled Hydrogen and Liquid/Solid Hydrogen Mixtures (Slush Hydrogen, SLH₂)

In Figure 8, density and enthalpy-difference ratios are presented for saturated (i.e., normal boiling-point, NBP) and subcooled hydrogen at its triple point of 13 K, where a liquid/solid mixture can be formed. This presentation relates to the potential use of so-called slush hydrogen (SLH₂). This is of interest to propulsion engineers from at least two standpoints: at the engine level, for performance enhancement of air-liquefaction-involved operating modes via the process of *hydrogen recycling* (to be covered subsequently), and at the aerospace vehicle systems level, for vehicle propellant mass-fraction improvements via fuel-densification effects. Taken together, the benefits of using slush hydrogen, in lieu of NBP liquid hydrogen as conventionally done, ramify into the potential for marked reduction of vehicle takeoff-condition weight and vehicle physical size.

In summary, as can be inferred from Figure 8, slush hydrogen provides for about a 15-percent (factor of 1.15) increase in fuel density and about a 20-percent increase in low-temperature heat sink. The fact that this added potential source of cooling is below the NBP liquid hydrogen temperature range is the key to obtaining recycling benefits which, for certain engine types operating modes can amount to the doubling of engine specific impulse through the resulting cycle leaning-out process of recycling (see later Figure 10).

LESS THAN FULL-AIRFLOW LIQUEFACTION BASED PROPULSION SYSTEMS

Several Distinct Technical Design Approaches Have Been Pursued

Yet another design approach for pursuing cycle lean-out strategies, this time one involving overall engine design considerations, effectively increase the refrigerative effect of the hydrogen by reducing the relative amount of air to be refrigerated to the point of liquefaction. This can be achieved in a multiplicity of ways by selecting other than 100-percent of the engine airflow to be liquefied, the remaining air then being cooled but not liquefied, or not cooled at all. Numerous design variations exist in this particular pursuit, including the following examples, taken here generically, with several specific engine types being noted:

(1) the cryojet family of engines, such as versions of "SuperLACE" and "PACE" (Precooled Air Cycle Engine), is one in which *none*, or only a small fraction, of the processed air is liquefied. The rest of the air is maximally cooled, and thereby densified, providing for much more compact, lighter weight, and lower-power-demand air-compression devices than conventionally required in, say, turbojet engines (see the above discussion of cryogenic air compressors). The net result is somewhat increased performance than typically achieved in true air-liquefaction systems in a lighter-weight engine than a conventional airbreathing system.

(2) Split-airflow engines have been conceptualized which fractionally divide the airflow into both a liquefied and a non-cooled airstream, the liquefied air being produced by cryogenic hydrogen heat exchange, pumped to pressure, and burned with hydrogen, under either fuel-rich or stoichiometric conditions, depending on the design. See later Figure 9 for a simplified schematic of the RamLACE engine concept which is based on this approach. This, in turn, provides the means of compressing the non-cooled airstream, following which, the remainder of the hydrogen is injected and burned in the compressed airflow. Examples include the Liquid Air Turbo-Accelerator (LATA) and the RamLACE/ ScramLACE family of concepts. The former uses a conventional mechanical compressor, the latter an air-augmented rocket type "jet compressor", which operates basically as an ejector .

(3) Precooled and/or Intercooled Turboaccelerators are basically conventional turbojet/ turbofan-based engines which use their limited available quantities of combustion hydrogen to cool the airstream somewhat, increasing its density to achieve advantages similar to those of cryojet systems. However, near-saturation cold-air conditions are not approached as they are in cryojets. In being compressed, the somewhat denser air allows for modest reductions in compressor hardware size and power extraction requirements, at the expense of the weight and airflow pressure-drop of the required heat exchanger.

(4) Hydrogen Expander, Regenerative Hydrogen Air Turborocket, Air Turbo Exchanger, and other such proposed engine types, are technically related to the above turbomachinery based systems, but they differ mainly through heat addition to the hydrogen from combustion processes, sometimes in addition to the heating provided by high-speed flight intake air (see, for example, the hydrogen-expander engine discussion in Reference 1). Larger quantities of compressor shaftwork can be extracted through subsequent turbine-expansion with such hydrogen heating, following which, the hydrogen is burned in the engine. These systems are not, however, usually viewed as "air liquefaction related" systems.

An Exemplary Split Airflow Combined-Cycle Engine Concept: RamLACE

One of the numerous cycle lean-out strategies, namely the second item in the above listing, involves a splitting of the engine-induced airflow into two or more streams, and liquefying only one of them. This approach is reflected in the RamLACE family of engines represented in Figure 9 in a simplified schematic. RamLACE was derived from the non-liquefaction Ejector Ramjet engine concept by researchers at Marquardt, sometime after the press of the original aerospaceplane predevelopment work subsided. This type of combined-cycle engine, while centering on the ramjet for operation in the Mach 3 to 8 flight-speed range, utilized an internal set of liquid rocket units ("primary rockets") which -- in effect -- were air-augmented in an ejector-like configuration. The resulting internal *jet compression* of the "secondary" air stream provides the opportunity to afterburn it in the ramjet combustor, and expand the combustion products through the nozzle, producing significantly more thrust than that of the rockets alone. At ramjet takeover the rocket unit would be turned off and ramburner operation continued. Thus was created a simple, lightweight bimodal supersonic/hypersonic engine not requiring any mechanical compression hardware, other than a set of compact, low-power-requirement propellants pumps. The Ejector Ramjet had reached a subscale ground-test status by the late 1960s, but RamLACE, though extensively addressed in conceptual design and application studies, is not known to have achieved such an experimental stage.

RamLACE as the Air-Liquefaction Variant of the Ejector Ramjet Engine

Whereas the Ejector Ramjet used conventional tanked bipropellants, e.g., hydrogen and oxygen, RamLACE uses liquid air (LAIR) directly processed through the now-familiar hydrogen-cooled heat exchanger and thus needs no tanked oxidizer. Nevertheless a fuel-richness problem remains, although it is considerably ameliorated since, typically, only about one-third of the air flowing through the engine must be liquefied, namely, that used in the primary rockets. It turns out that cycle- dictates require a *stoichiometric* primary rocket operation, so that the excess (over stoichio- metric) hydrogen is fed to the afterburner, which thereby operates considerably fuel-rich. At an overall engine fuel/air equivalence ratio of around 4 (half of Basic LACE's), the sea-level static specific impulse is about 1400 seconds, and this increases markedly with flight speed, according to the build-up of ram-pressure in the inlet diffuser. This marks the onset of high- performance ramjet-mode effects prior to the termination of the ejector (air liquefaction) mode, it being still required to achieve the required level of vehicle thrust, prior to full ramjet-mode takeover.

TECHNOLOGICALLY RELATED PROPULSION SYSTEMS CONCEPTS

Recycled RamLACE/ScramLACE

Recalling earlier Figure 8 which characterized the density and enthalpy nature of slush hydrogen, *hydrogen recycle operation* is yet another performance improvement avenue in the pursuit of the cycle leaning-out strategy. It is reflected in the *Recycled ScramLACE* engine concept represented in Figure 10; this is basically a scramjet-capable variant of RamLACE, covered in the previous paragraphs. Note that the vehicle hydrogen tank is brought into the picture, and that the heat

exchanger is now equipped with a hydrogen-return line positioned in between the condenser and the pre-cooler. In this arrangement, the amount of cryogenic hydrogen available for liquefying the air is substantially greater than that immediately to be consumed in the engine. The cycle is accordingly leaned out. The recycled hydrogen is returned as warmed up gaseous hydrogen which is to be *reliquefied* within the hydrogen tank. The fuel that is initially tanked *must* be slush hydrogen, or at least subcooled liquid; recycle cannot be performed with NBP hydrogen since there is no usable heat sink in the tanked fuel. Unacceptable boil-off effects would be encountered. Typically, as mentioned earlier, a 50/50 slush mixture is used at the triple point temperature (13 K, 25 R).

In operation, the amount of *liquid* hydrogen (ideally, slush is *not* removed from the tank) which is passed through the temperature-pinch-limited condenser can be well in excess of that passing into the engine's combustors, distinctly not the case in non-recycled air liquefaction engines. This means a larger quantity of air can be liquefied than otherwise, and the cycle thus made less fuel-rich -- the basic performance objective. The recycled hydrogen, now somewhat warmed up, but still a cryogenic fluid, is returned to the tank. In certain designs a turbine expander is placed in this return line, providing cooling and power extraction, as previously covered. The recycled hydrogen is then reliquefied by indirect (via a heat exchanger) and direct contact (i.e., hydrogen injection into the tanked fuel) with the remaining subcooled tanked hydrogen. This, in turn, adds heat to the tanked fuel, melting the solid hydrogen and in a relatively brief period, raising the bulk temperature toward NBP conditions (20 K, 36 R).

This recycling process is obviously constrained by finite stored-enthalpy considerations, hence it is operating-time limited. Accordingly, an assigned *recycle rate* is established for the air-liquefaction dependent ejector-mode operation such that the remaining tanked hydrogen just approaches NBP conditions, as the engine is to be shifted to ramjet mode where air liquefaction ceases. Thereafter, the non-liquefaction modes to follow, in this case ramjet and scramjet operation, continue in conventional fashion insofar as the fuel supply is concerned.

The recycle rate is taken to be the fraction (stated as a percent) of the total hydrogen flow entering the heat exchanger which is returned to the tank. The range of practical interest is about 25 to 50 percent, 0 denoting a non-recycled case. Hydrogen recycle operation, for realistic recycle ratios can, at best, *about double* the specific impulse of an equivalent non-recycle engine. For example the previously stated 1400 seconds for RamLACE would rise to about 2700 seconds in an optimal Recycled RamLACE engine. However, the heat exchanger condenser would now be larger, hence significantly heavier, to handle the augmented flows. The added fuel-circuit hardware required for recycling and reliquefaction adds weight and complexity as well. The most significant challenge, perhaps, is the proposition of producing, servicing and maintaining slush hydrogen in the vehicle propellant tank, and then providing a practical heat-exchange means for using this additional low-temperature heat-sink to cool and completely reliquefy the recycled warmed-up gaseous hydrogen.

SUPERLACE: SYNERGISTICALLY INTEGRATING SEVERAL CYCLE LEANING-OUT OPTIONS

Multiple-Process Makeup and Operation of a Representative SuperLACE Concept

Once again, proceeding from Basic LACE, the various technologies discussed so far were, by and large, integrated into a class of propulsion systems generically referred to as *SuperLACE*, one example being reflected in Figure 11. This involves as many as three of the cycle-lean-out strategies cited earlier, plus a fourth one not yet discussed: use of a LAIR regenerator/boiler as a pre-pre-cooler in the heat exchanger train. All four are integrated in this particular engine concept as reflected in the

simplified flow schematic of Figure 11. Starting with the vehicle fuel supply, it can be seen that slush hydrogen is initially tanked to provide for recycle operation, as just described. Secondly, as covered earlier, the pressurized and warmed-up recycle hydrogen is passed through a turbine expander for cooling and shaftpower generation (e.g., as needed to drive the various turbopumps).

Thirdly, a para/ortho shift conversion catalyst is incorporated into the cryogenic heat exchanger. It is shown here as an external unit located flow-wise between two portions of the condenser. Actual design practice would likely be otherwise; for example it has been suggested that the fairly bulky and heavy catalyst be placed in the air-header sections *throughout both* the condenser and the precooler elements to continuously catalyze the endothermic para/ortho shift, as the hydrogen progressively warms up.

Returning to the fourth avenue named above, the LAIR regenerator/boiler adds a non-hydrogen heat exchanger at the front end of the regular precooler. This uses high-pressure LAIR as coolant for initial cooling of the warm-to-hot air extracted from the inlet diffuser. This provides the double advantage of warming up the engine's oxidizer stream (thermodynamic advantage) while gasifying the LAIR (practical combustor design advantage), on the one hand, and providing augmented precooling of the air, reducing the cooling load of the hydrogen-cooled heat exchanger, on the other.

The SuperLACE features described here mainly apply to the initial acceleration mode for an engine which usually offers high-speed ramjet (but not necessarily scramjet-mode) operating capability. This system can be integrated with the Air Collection and Enrichment Systems (ACES). This distinctly complementary approach is described in References 1-3, but not in the present paper. Such a SuperLACE/ACES combination concept will be next described. Since the various cycle lean-out techniques (i.e., the four described) operate independently, their effects are productively compounded. Proponents of SuperLACE claimed near stoichiometric operating possibilities resulting in, as will be seen, specific impulse levels of that of an advanced hydrogen-burning turbojet cycle, ca. 6000 seconds at sea level static conditions.

SuperLACE/ACES for Single Stage to Orbit Applications (as proposed in the early 1960's)

As suggested in the previous discussion, the two advanced air-liquefaction based concepts covered earlier, SuperLACE and ACES, were combined into a single, integrated Earth-to-orbit propulsion system: *SuperLACE/ACES*. Its performance characteristics are presented in the specific impulse vs. flight speed plot of Figure 15, one which clearly reflects the principle of *multimode operation* in a single-stage-to-orbit system. A reference hydrogen/oxygen rocket specific impulse level is provided (dashed line at bottom of the plot). Also, Basic LACE is reflected over its maximally-assigned speed range of 0 to Mach 8. This is about 1000 seconds at sea-level static conditions, dropping off to half that at its upper speed limit. This is largely a consequence of the very large ram-drag force component sustained in a hypersonic inlet that must completely "stop" the airflow in order to liquefy it statically.

The two near-vertically running lines labeled "Hyperjet" refer to operating mode transitions in a convertible rocket/ramjet concept by this name created by Marquardt, sometimes alluded to as an inlet valved-off ramjet. This serves as a low chamber-pressure rocket from static conditions up to ramjet takeover speeds of about Mach 2. Here the inlet valve is open and the unit operates as a ramjet. Either hydrogen/oxygen or hydrogen/LAIR (i.e., Basic LACE) initial rocket operation can be considered (the two lines on the left). The descending line between Mach 4 and 8 marked "ACES" (as well as "Hyperjet") is simply what was anticipated as performance of a hydrogen-fueled subsonic combustion ramjet system. Ground testing of such a subscale, flightweight hydrogen-cooled ramjet engine was ultimately carried out by Marquardt for the Air Force ca. 1968.

High-Speed Operation - The hatched triangular area in the Mach 8 to 16 speed range marked "growth" represents a potential scramjet-mode extension of speed-limited ramjet operation. It should be noted that, at the time this SuperLACE/ACES approach was being considered (early-1960's), scramjet (*supersonic-combustion ramjet*) operation was only being analytically investigated by the propulsion research community. Hence it was not sufficiently mature, as a working propulsion choice, for assimilation into propulsion system concepts being readied for near-term development. It therefore was viewed, as alluded to here, as a "growth" performance enhancement measure.

Above Mach 8 then, ignoring this "growth" area for the moment, ACES involved rocket operation on LEA/Hydrogen using the Hyperjet (with inlet closed). The dashed line just below the oxygen/hydrogen rocket line reflects the slightly lower rocket performance predicted with the nitrogen-diluted oxidizer to be used (LEA). However, since oxygen "tanking up" takes place at supersonic/hypersonic flight speed and high altitude conditions, rather than on the ground at zero speed, a much higher *equivalent* specific impulse value can be calculated, as shown in the elevated curve ranging from about 1500 down to 1000 seconds. In effect, this is the payoff of ACES as related in terms of engine performance trends.

SuperLACE Operation - This leaves only the "low speed" operation of SuperLACE to be covered. It is as described in the previous chart, i.e., a design involving the compounding of several cycle- leaning-out measures. The objective was to approach stoichiometric operation, thereby achieving much higher specific impulse levels than are available from Basic LACE. As displayed here, in the pre-ramjet flight-speed range of Mach 0 to 3-4, this engine cycle (or set of cycles) is stated to provide 5500 to 6500 seconds of specific impulse statically, ranging down to 4500 seconds at ramjet takeover. As pointed out earlier, this is the level of performance which, from today's perspective, can be estimated for an optimal near-stoichiometric turbojet engine operating on hydrogen fuel. To the extent that SuperLACE is a credible concept, this same level of performance is (perhaps, better, was) seen to be provided by a relatively simple (no major rotating parts), lightweight engine.

FURTHER CONSIDERATION OF RAMLACE/SCRAMLACE

Some few years following the demise of aerospaceplane, new alternative air liquefaction based propulsion system concepts arose, still using much of the same technology which evolved through the earlier research and predevelopment activities previously described. Now, however, with much more analytical and testing background being available, the salient importance of the hyper-sonic hydrogen-fueled ramjet, including both sub- and supersonic-combustion variants, became a dominant factor in the design- selection process. The dual-mode or convertible ramjet/scramjet concept was born (and tested). Since this provided telling performance advantages, most of these intermediate-period alternative concepts focused on achieving maximum-performance ramjet/scramjet mode capability, as well as striving for minimal complexity and lightweight construction. Along with their non-liquefaction family members (e.g., Ejector Ramjet, Ejector Scramjet), such concepts as RamLACE and ScramLACE were proposed and explored analytically and at the conceptual design level. These concepts were introduced earlier in Figures 9 and 10. This conceptual design work was performed mostly by Marquardt and its contractor associates for the Air Force and later for NASA).

In Figure 13's representation of these engine types, it is shown how such propulsion systems, departing from the progenitor Basic LACE concept largely by incorporating various cycle-leaning-out strategies, have led to several high-performance ramjet-centered engine types which are comparatively simple and lightweight. As a direct consequence of their air-liquefaction related operation, these concepts can also achieve high *initial* levels of performance without recourse to large, heavy rotating machinery. RamLACE and its recycled (slush hydrogen) variant are shown here, but this applies equally well to the ScramLACE (scramjet capable) family of concepts.

In some cases this class of engine integrates a fan-supercharging subsystem which somewhat improves initial performance and operability, but mainly is proposed to provide a competent vehicle end-of-mission subsonic loiter and powered landing capability at very high levels of specific impulse. Although limited in thrust and speed range, the hydrogen-fueled high bypass ratio turbofan cycle involved can achieve specific impulse levels of the order of 30,000 sec. This ramifies favorably to a low loiter/landing fuel mass requirement.

SUMMARY AND CONCLUDING REMARKS

Summarizing this brief report of a survey of cryogenic hydrogen-induced air-liquefaction technologies as developed in the U.S. several decades ago, and which are evidently of renewed interest today, the following key observations can be offered in conclusion:

- Work began with the Basic LACE concept originated in the mid-1950s, which became the progenitor of numerous air-liquefaction related technologies, leading aspects of which have been discussed in this paper.
- Air liquefaction related concepts proliferated, many reaching the predevelopment hardware stage, in direct response to the technically ambitious goals of the original aerospaceplane program, of which the U.S. Air Force was the leading sponsor.
- A fundamental technological edict quickly emerged, one which was actively pursued through several different design strategies at the time, as a direct consequence of the inherent fuel-richness of the Basic LACE concept: *Lean out the cycle*.
- SuperLACE/ACES, perhaps, represented a culmination of advanced propulsion thinking of this era; SuperLACE combining a multiplicity of cycle-lean-out measures, and ACES extending "airbreathing" operation beyond the then-perceived ramjet flight-speed limit (Mach 8) all the way to orbital speed (recall scramjet, as a prospective means to thus extend airbreathing flight speeds, was then just on the technological horizon).
- Subsequently, in the mid-1960's, the development and demonstration in flight-hardware of hydrogen-fueled ramjet ground-test engines led to the Ejector Ramjet family of engine concepts. The air-liquefaction based variant was the RamLACE engine. Further research efforts on extending high-speed airbreathing operation beyond Mach 6-8 flight speeds led to a strong focus on the potential of supersonic combustion ramjet (*scramjet*) mode operation of a combined-cycle engine. Again, the air-liquefaction variant of the resulting Ejector Scramjet concept was the ScramLACE concept.

Renewed interest has been evidenced internationally, over the past five years or so, toward once again capitalizing on many of these same cryogenic hydrogen air-liquefaction technologies; this thrust may be particularly significant today, now that air-liquefaction basic process-enabling *liquid hydrogen* has been universally adopted as the staple fuel for rocket-powered space-vehicle systems (see Reference 5 for an authoritative technohistorical treatment of this specific subject). Liquid hydrogen fuel is now also under serious consideration for proposed hypersonic airbreathing-powered vehicles which may well be powered by combined-cycle engines of the type considered in this presentation.

REFERENCES

1. Escher, W.J.D. and Doughty, D.L., "Assessment of Cryogenic Hydrogen-Induced Air-Liquefaction Technologies", Astronautics Corporation of America final report under SAIC Subcontract No. 15-860020-82, under U.S. Air Force Prime Contract No. F33615-84-C-0100, September 1986 (limited/restricted distribution)
2. Escher, W.J.D., "Cryogenic Hydrogen-Induced Air-Liquefaction Technologies," NASA Headquarters paper presented at the NATO Advisory Group for Aerospace Research and Development (AGARD) 75th Symposium of the Propulsion and Energetics Panel on Hypersonic Combined Cycle Propulsion. 28 May - 1 June 1990, Madrid, Spain
3. Escher, W.J.D., "Cryogenic Hydrogen-Induced Air-Liquefaction Technologies," NASA Headquarters paper presented at the 1990 JANNAF Propulsion Meeting, 2-4 October, Anaheim, California
4. Anon., "Liquid Air Cycle Engine, film report by The Marquardt Corporation presented at the annual meeting of the Institute for Aeronautical Sciences, 1961
5. Sloop, J.L., "Liquid Hydrogen as an Aerospace Fuel 1945-1949," NASA SP-4404, 1978

Author's note: Reference 3 is a rewritten, somewhat references-expanded version of Reference 2. Reference 2 is basically a summary of the work reported in Reference 1. Finally, the present paper is a shortened version of Reference 3.

BASIC LACE (LIQUID AIR CYCLE ENGINE)

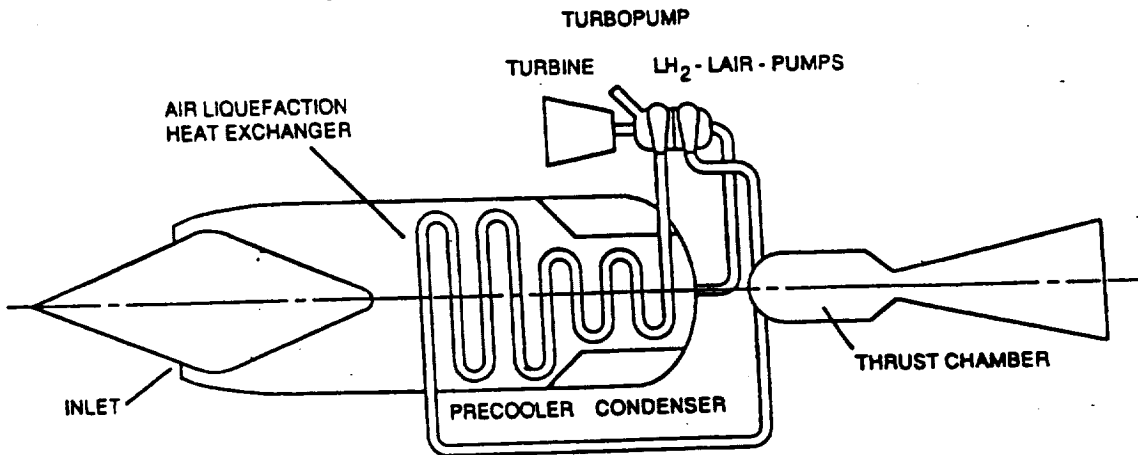

Basic LACE $I_s = 1000$ lb/lbm/sec
 $\phi = 8$

CRYOGENIC HYDROGEN-INDUCED AIR LIQUEFACTION: AN INTERRELATED CLUSTER OF DIVERSE TECHNOLOGIES

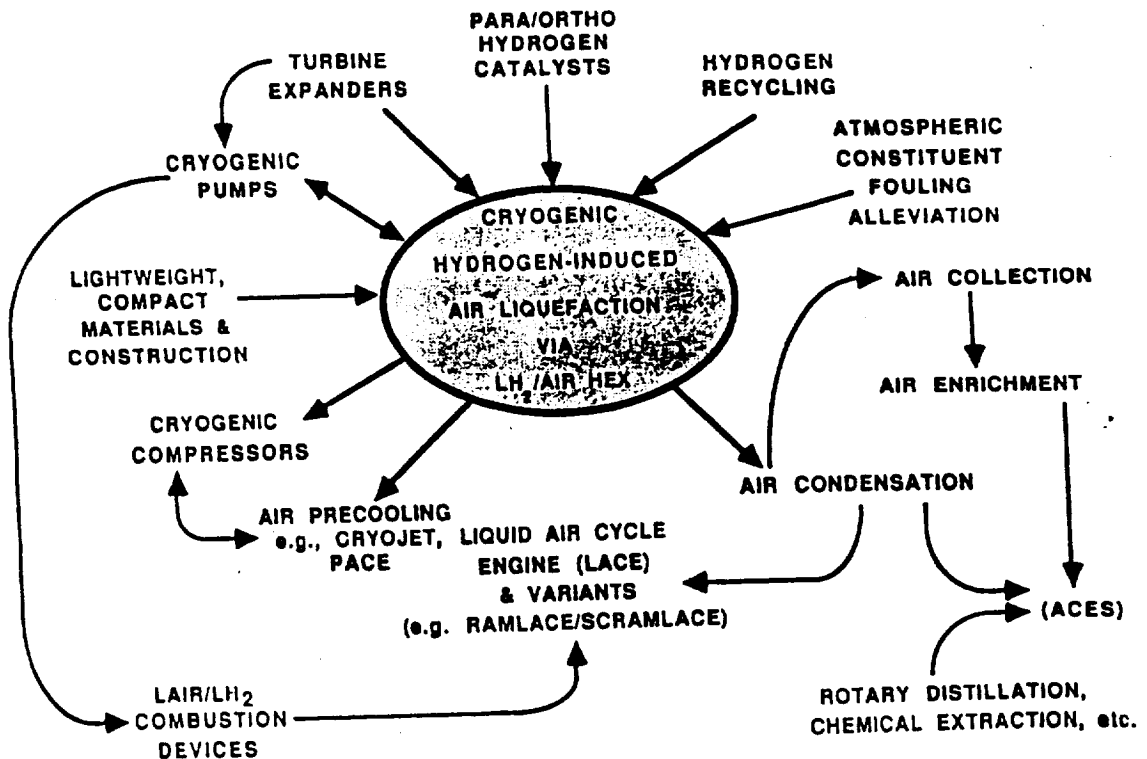

HEAT EXCHANGER SCHEMATIC & KEY NOMENCLATURE

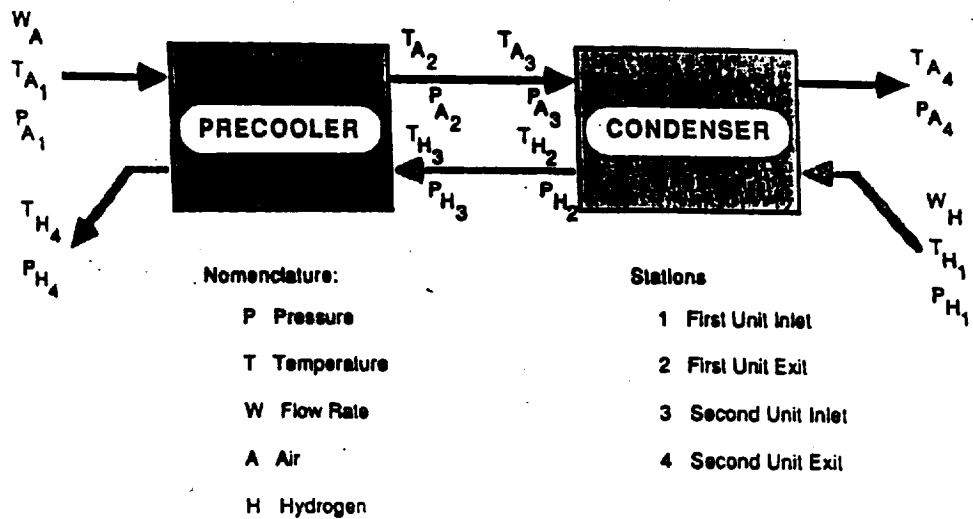

TYPICAL HEAT EXCHANGER MATRIX DESIGNS

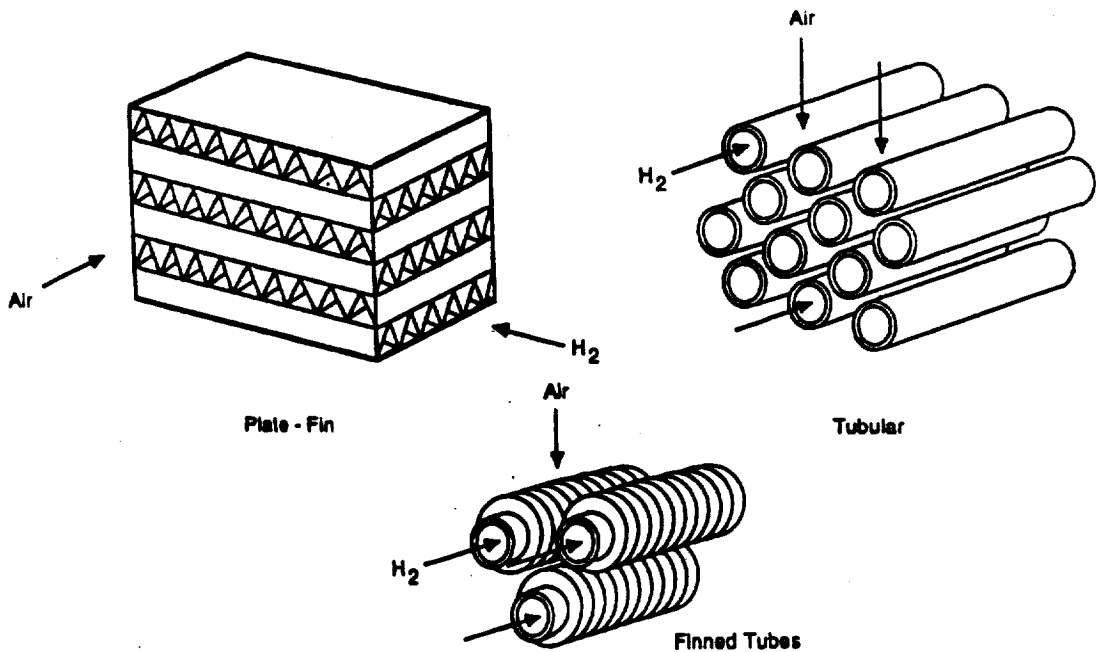

REPRESENTATIVE CROSS-COUNTERFLOW TUBE-IN-SHELL HEAT EXCHANGER DESIGN

Note: In Air Liquefaction Heat Exchangers
of this General Configuration,
Fluid 1 is Cryogenic Hydrogen and
Fluid 2 is Air.

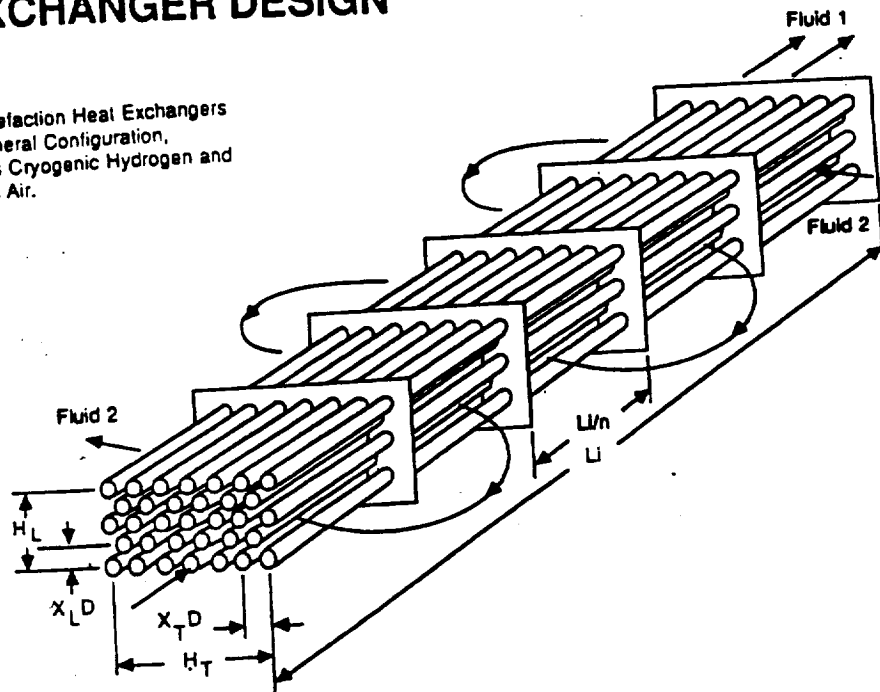

TYPICAL EXPERIMENTAL TEST SET-UPS

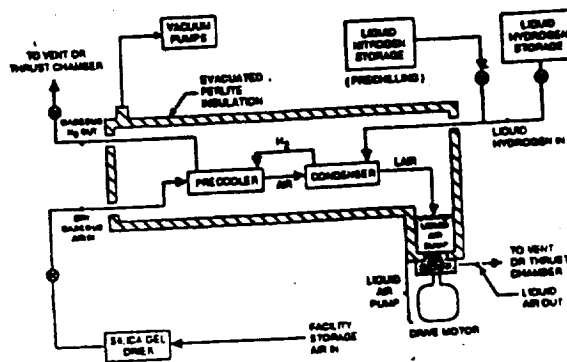
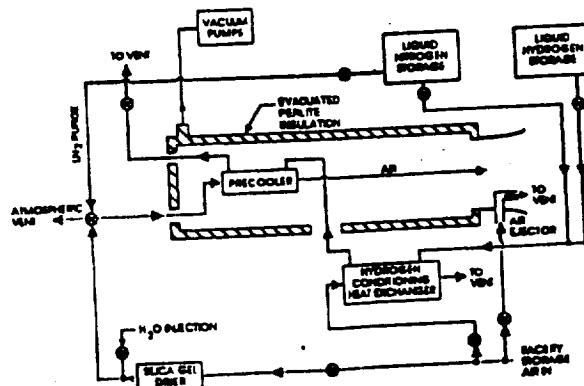

HYDROGEN PARA-FORM CONTENT vs. TEMPERATURE

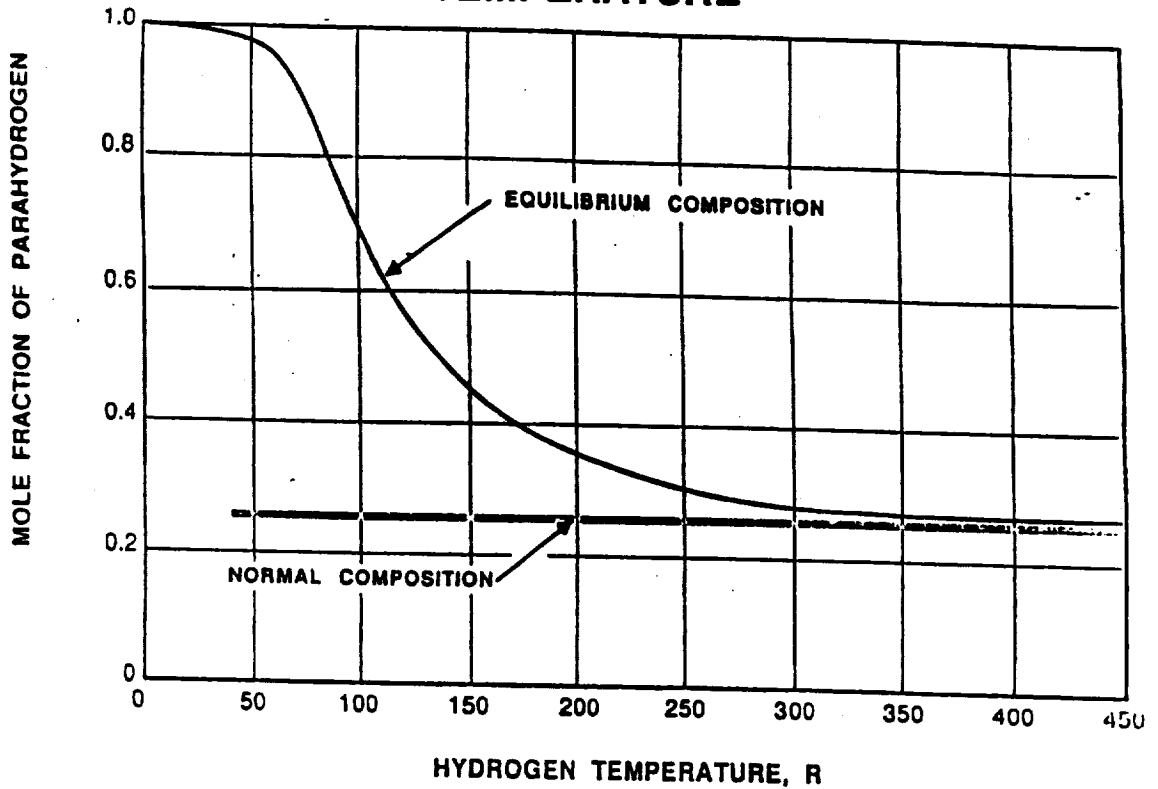

DENSITY AND ENTHALPY DIFFERENCE RATIOS vs. LIQUID/SOLID CONTENT OF SUBCOOLED LIQUID HYDROGEN

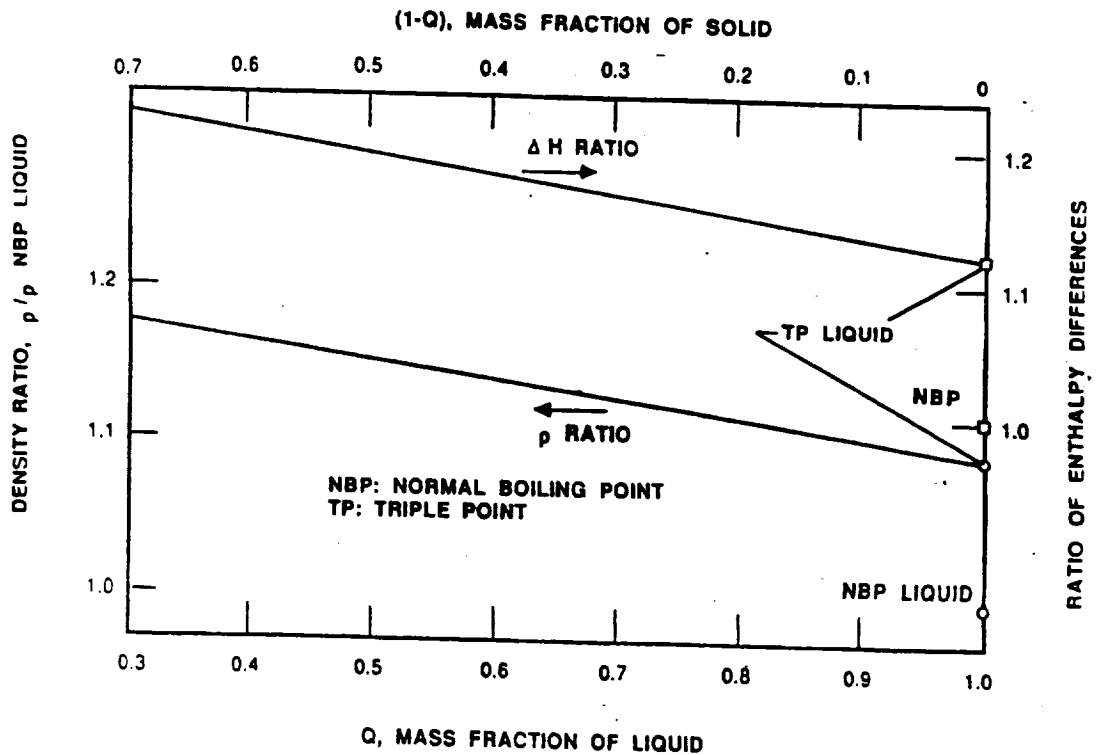

RAMLACE ENGINE

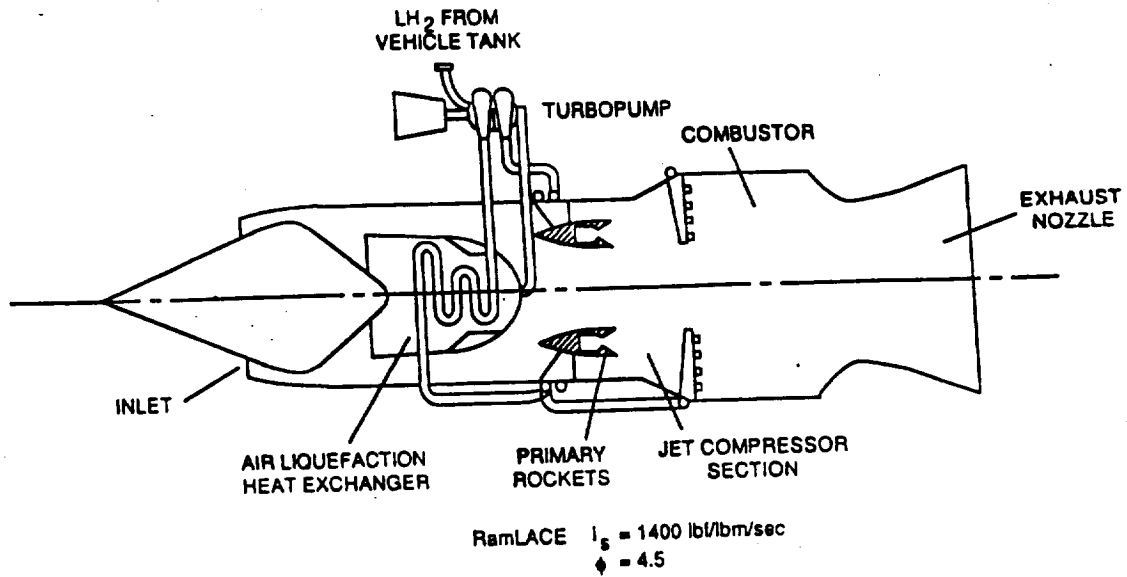

HYDROGEN RECYCLE OPERATION (IN SCRAMLACE ENGINE)

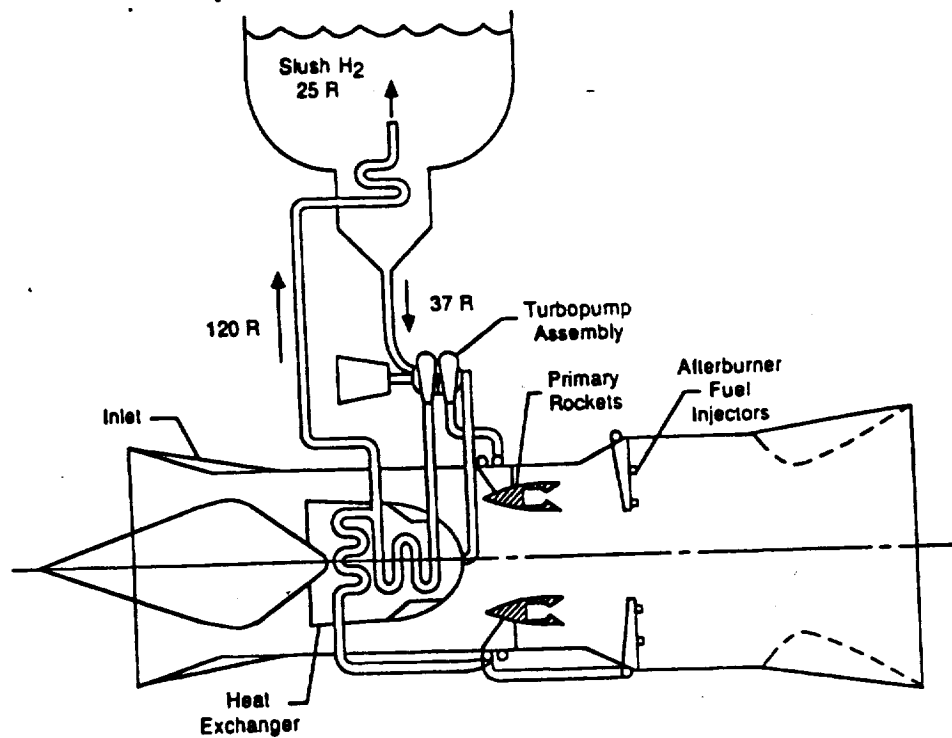

REPRESENTATIVE SUPERLACE SYSTEM

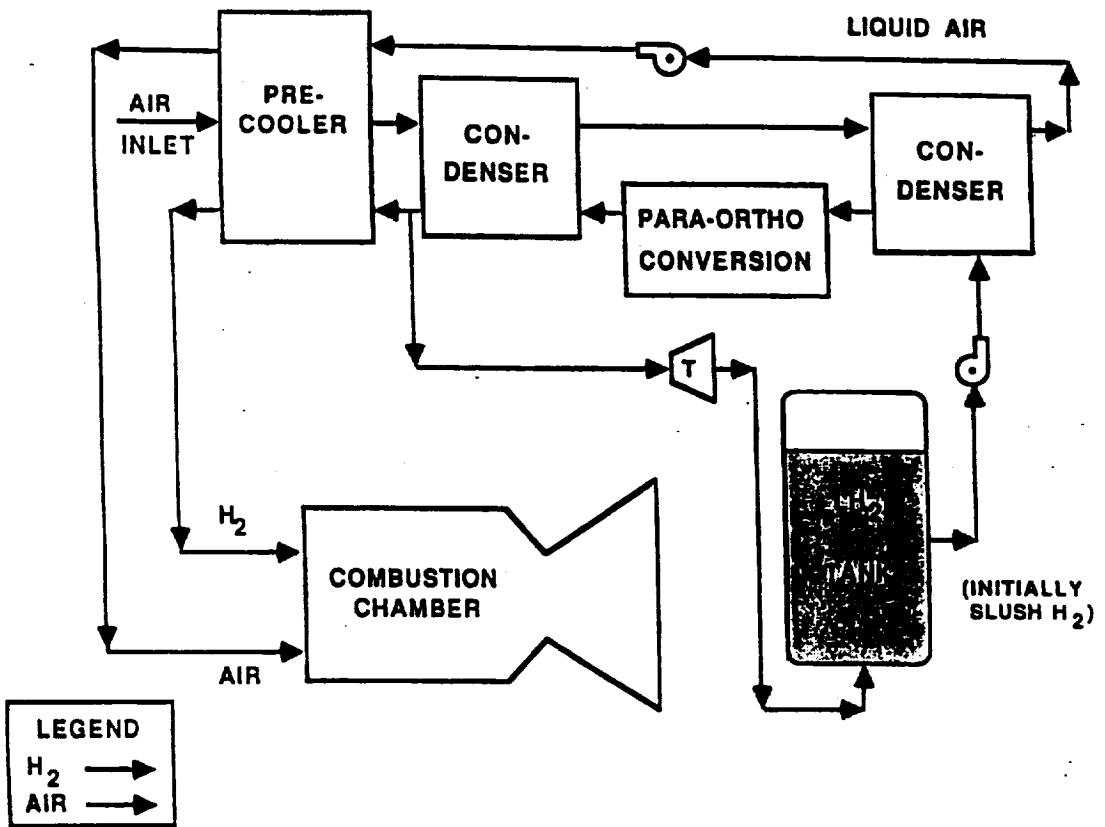

SUPERLACE/ACES SPECIFIC IMPULSE vs. FLIGHT VELOCITY

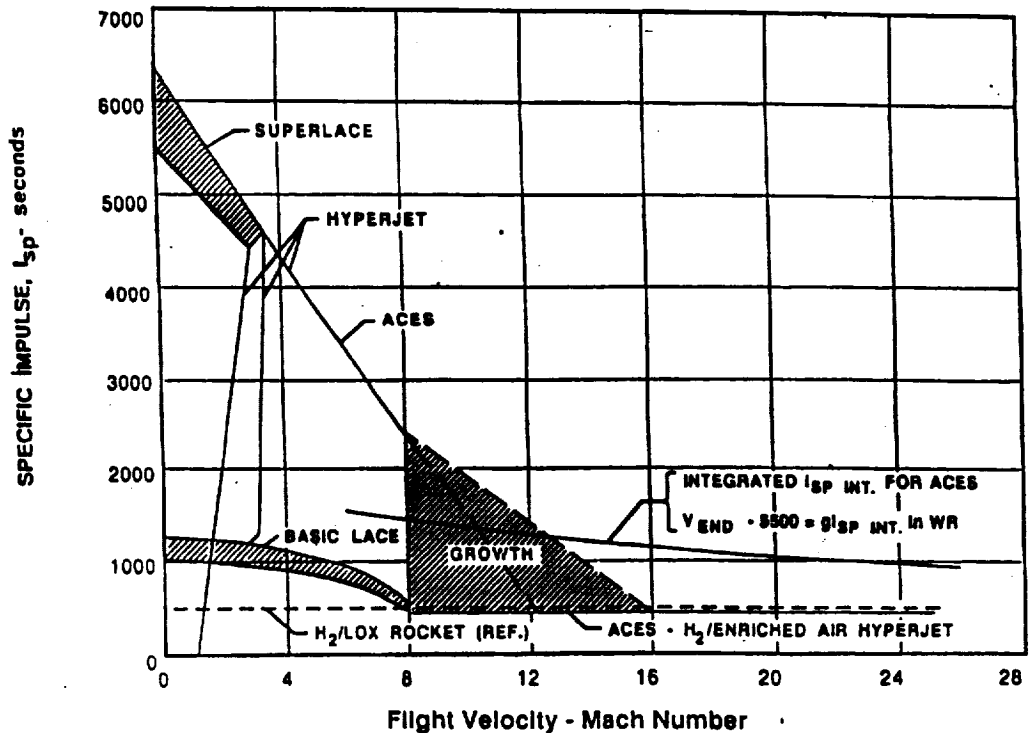

PROGRESSIVE "LEANING OUT" TRENDS: BASIC LACE/RAMLACE/RECYCLED RAMLACE

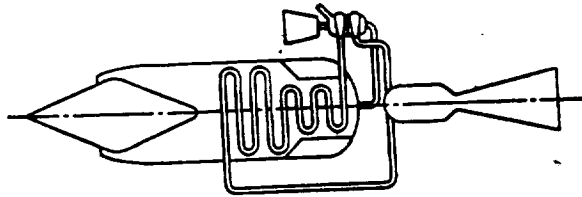

Basic LACE $I_s = 1000$
 $\phi = 8$

I_s is for Sea Level Static Conditions
 ϕ = Net Engine Equivalence Ratio

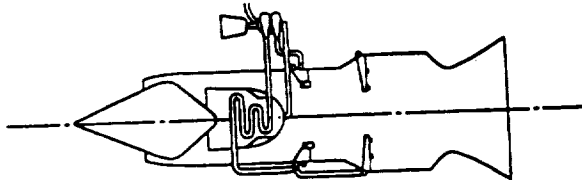

RamLACE $I_s = 1400$
 $\phi = 4.5$

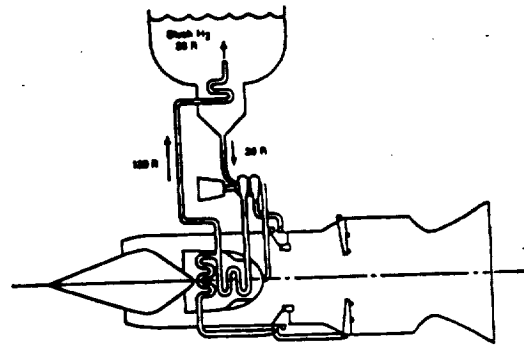

Recycled RamLACE $I_s = 2700$
 $\phi = 2$



N92-21527

SUPERCHARGED EJECTOR RAMJET

Jerry Rosevear
Kaiser Marquardt
Van Nuys, CA 91406

1992012285
628259
10p.

I. INTRODUCTION

System mission requirements consisting of broad Mach number and altitude operability impose severe and challenging demands on the propulsion system. A single thermodynamic cycle is incapable of satisfying these broad requirements. Therefore, it is desired to incorporate the best features of the appropriately selected propulsion elements, based on the mission requirements, into an integrated propulsion system. The Supercharged Ejector Ramjet (SERJ) is such a combined cycle. As reflected symbolically in Figure (1), the SERJ engine is comprised of three basic semi-independent subsystems: fan (compressor) supercharger system(s) driven by a small airbreathing gas generator, an ejector pumping system (E) and a ramjet (RJ) system.

Under Air Force Systems Command Sponsorship, significant exploratory development was achieved by Marquardt on a building block basis for the SERJ propulsion system. Following small scale rig testing of the basic cycle components in 1963, progressively improved 18-inch engine demonstrations were conducted on various propellants. These investigations have covered simulated flights from sea level to Mach 3. Fan, ejector and combustor tests continued through 1969 under IR&D, NAVAIR and USAF-APL sponsored programs.

The SERJ engine concept was experimentally evaluated in the supercharged ejector mode, the ramjet mode, the fan mode and the pure ramjet mode. The experimental results validated analytical performance predictions.

II. OBJECTIVES AND BENEFITS OF SERJ

The primary objective of a composite engine cycle, such as the SERJ, is to provide versatility of satisfying thrust requirements efficiently in a broad altitude-Mach envelope. This is accomplished by judiciously selecting one or more sub-elements of the engine without sacrificing their performance. High thrust levels for takeoff and climb-out is provided by the fan-ejector-ramjet operating mode. Efficient cruise performance is accomplished by the fan-ramjet mode for transonic and low supersonic speeds or by the ramjet for higher supersonic speeds. Super performance for high "g" maneuvers is instantly achievable by operating ejectors with the fan and/or ramjet.

With the multi-mode operating characteristics in mind, a typical engine operating envelope is presented in Figure (2). This chart shows the operating capability of the engine from zero to Mach 5 and from sea level to 140,000 feet altitude, operating with individual mode limits as indicated. As is shown at the various Mach number conditions, typically more than one operating mode is available depending upon the thrust demand and fuel efficiency (low specific fuel consumption) requirements.

The engine operational characteristics can be tailored to any specific system requirements. The inherent SERJ performance and operational flexibility makes it a superior propulsion system than one element engines such as a rocket or a turbojet.

III. GENESIS OF THE SERJ ENGINE

Integration of the ramjet and liquid rocket powerplants is fundamental to the concept of the composite propulsion system. The Ejector Ramjet engine is an elemental composite system which has been studied by Marquardt and found to be attractive for a number of high speed acceleration and cruise applications. Consideration of the practical aspects of aircraft flight profiles has led to the integration of a third element, the high bypass ratio lift/cruise fan. Inclusion of this component provides a capability for low speed, high efficiency aircraft loiter and intermediate flight speed operation. The Supercharged Ejector Ramjet, then, is a composite propulsion system integrating the three elements or subsystems as shown in Figure (3).

The individual technological bases for the rocket, the ramjet, and the fan components, insofar as the near term SERJ engine is concerned, exist at this time. Development problems then, are basically concerned with the integration of these subsystems to achieve an optimal aircraft powerplant.

IV. SERJ TECHNOLOGIES AND STATUS

The experimental component exploratory development and system feasibility level programs have been conducted by Marquardt since early 1960. In addition to company IR&D fundings, these programs were sponsored by Air Force-APL, Navy NAVAIR and NASA. These efforts continued to late 1960's and early 1970's. During this period component technologies were experimentally demonstrated. These components were later integrated into Ejector Ramjet (ERJ) and SERJ demonstrated hardware for concept evaluation and validation.

Typical component experimental programs are illustrated in Figure (4). Primary/secondary jet mixing (upper left) and afterburning following mixing and diffusion of the primary gases and the entrained air (lower left) were successfully performed. The results achieved in these early tests were highly favorable such that an 18-inch boilerplate engine was designed, constructed and operated in 1964.

Subsequently, hydrogen/oxygen rocket of boilerplate water-cooled construction were fabricated, individually tested (center picture) and installed in engine number 2, a freejet unit (right picture). This engine was tested in Marquardt's Cell 2 facility with freestream Mach number and altitude simulation. Hydrogen peroxide and hydrocarbon fuels were used as propellants.

In addition, the feasibility of a fan operation at high speeds including windmilling were demonstrated. The test results indicated the feasibility of windmilling fan at supersonic flight speeds with acceptable pressure losses. The feasibility of a wide operating range combustor concept was demonstrated over the anticipated engine operating envelope.

V. EJECTOR RAMJET ENGINE

The Ejector Ramjet is fundamentally simple in its physical make-up as shown in the schematic, Figure (5). Multiple primary chambers are located aft of the inlet diffuser at the forward end of the engine. High-energy primary exhaust gas is mixed with induced air in a constant area mixing section to increase significantly the air total pressure. The near-sonic mixed gases are then diffused to provide the highest practical static pressure at the afterburner inlet. Fuel is injected and burned in the afterburner section to consume the oxygen in the induced air. The resulting high pressure, high temperature gases are then expanded through an exit nozzle.

Cycle analyses, substantiated by experimental work, has shown that maximum performance is attained with stoichiometric (non-fuel rich) primaries to preclude combustion during the mixing process, with all combustion taking place in the higher pressure conditions in the afterburner.

The sea level static thrust and specific impulse of the Ejector Ramjet is significantly higher than the performance of a correctly expanded rocket engine, with the augmentation ratio increasing rapidly with increasing air speed. In general, the most effective operation favors gradual throttling or reduction of the primary flow between Mach 1.0 and Mach 2.0 to 2.5, after which the propulsion system operates on afterburner-only, as a conventional ramjet.

The engine was successfully tested in Marquardt's Cell 2 facility in 1966 with varying altitude and Mach number conditions.

IV. SUPERCHARGED EJECTOR RAMJET ENGINE

The SERJ engine is derived by integrating a fan supercharging system with an ejector ramjet engine. A conceptual SERJ engine design is depicted in Figure (6). The three major subsystems of the engine are the fan system, the ejector system and the ramjet system. The airbreathing gas generator and the ramjet are operated with JP fuel. Hydrogen peroxide was used for the ejector system.

The multiple nozzle ejector subsystem is located aft of the fan. High energy primary exhaust gases evolving from the decomposition of high pressure hydrogen-peroxide is mixed with induced air in a short mixing section to increase significantly the air total pressure and temperature, and to add additional free oxygen. The mixed gases are then diffused to provide the highest

practical static pressure in the ramjet combustor. Hydrocarbon fuel is injected and burned in the ramjet combustor section to consume the oxygen in the inlet air and that exhausted by the primary gas generator. The resulting high pressure, high temperature gases are then expanded through an exhaust nozzle.

The SERJ concept was demonstrated without the fan supercharger by simulating fan exit conditions (temperatures and pressures) at the ejector entrance plane.

VII. SERJ ENGINE CAPABILITY

Specific impulse for various thermodynamic cycles including the SERJ engine are compared in Figure (7). These individual cycles operate efficiently in a relatively narrow range of flight speeds. However, the SERJ cycle covers a much broader Mach number operating range as it can function efficiently in various modes depending upon the mission requirements.

At high flight speeds (Mach greater than 2), the ramjet cycle clearly indicates its superiority in specific impulse. However, at lower speeds its performance deteriorates very rapidly.

The SERJ cycle on the other hand covers this flight regime very efficiently. The engine provides a broad operational range in the ejector and the supercharged ejector ramjet modes of operation. As the thrust requirements decrease the specific impulse is improved at the specified flight condition by programmed throttling built into the engine. The fan/ramjet mode of operation provides the most efficient cycle resulting in very high specific impulse at low speeds.

The SERJ engine provides a versatile propulsion system to meet the mission thrust requirements most efficiently in a compact installation.

VII. CONCLUSIONS AND RECOMMENDATIONS

The SERJ engine is a highly flexible and promising composite propulsion system offering significant payoffs in high performance vehicle systems. Its basic subsystems such as fan, ejector and ramjet have been experimentally demonstrated. These components have also been integrated into engine demonstrators and tested in Marquardt Cell 2 facilities. This technical data base would result in a low risk and low cost propulsion system development program.

It is recommended that Marquardt's past SERJ related test data and studies be reviewed and updated by incorporating state-of-the-art technologies.

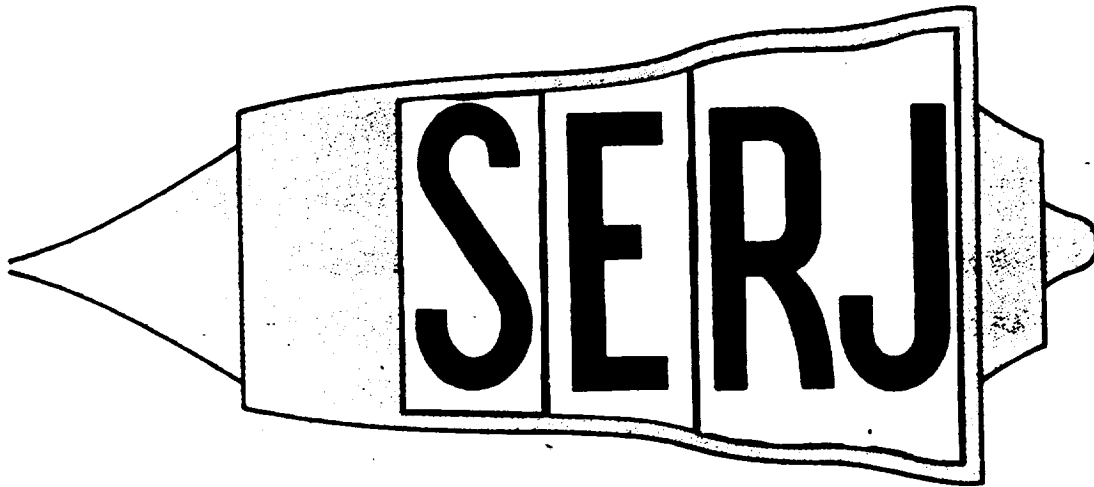

SUPERCHARGED EJECTOR RAMJET

Figure 1: Supercharged Ejector Ramjet (SERJ) is comprised of supercharger (fan), ejector and ramjet subsystems

TYPICAL ENGINE OPERATING FLIGHT ENVELOPE

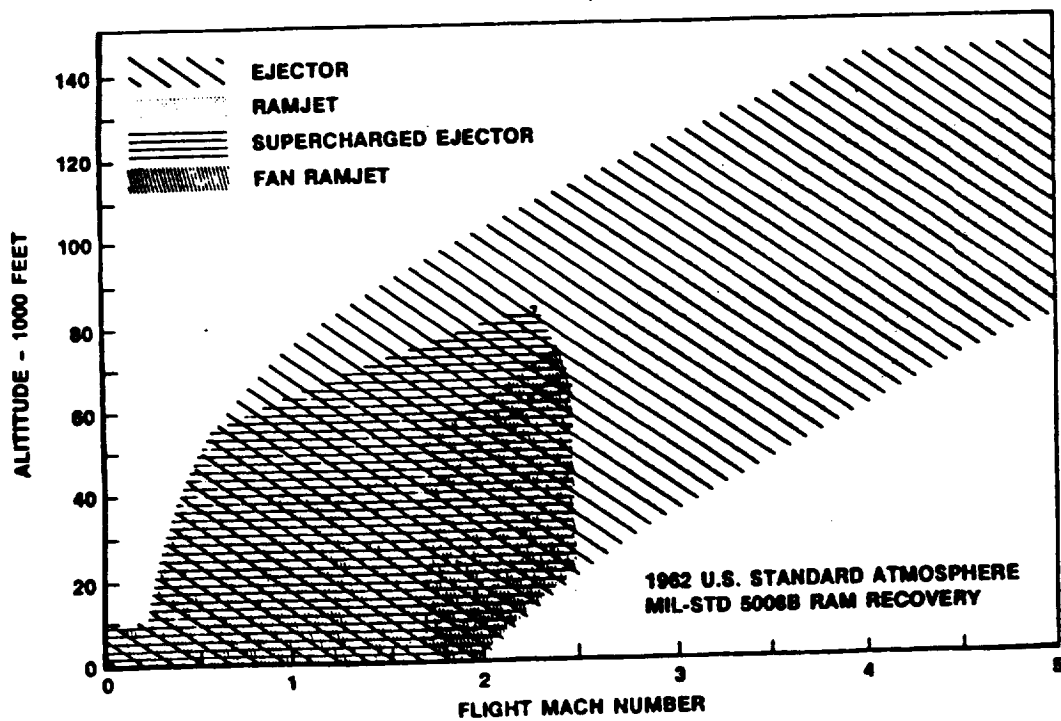

Figure 2: Typical SERJ engine operating flight envelope

GENESIS OF THE SERJ ENGINE

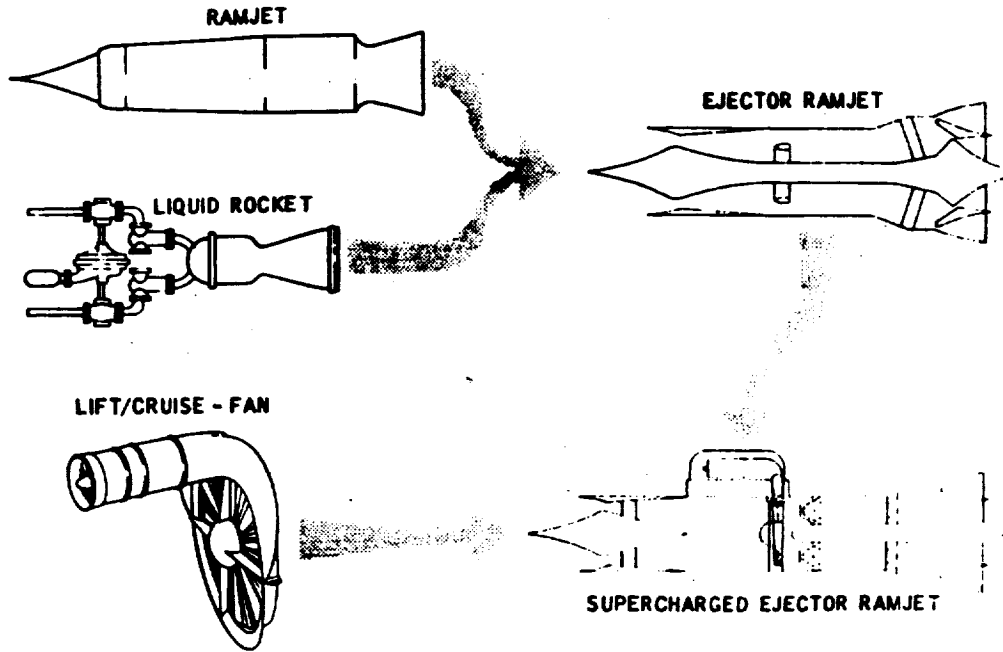

Figure 3: Genesis of the supercharged ejector ramjet engine

SERJ PREPARATORY EXPERIMENTAL PROGRAMS

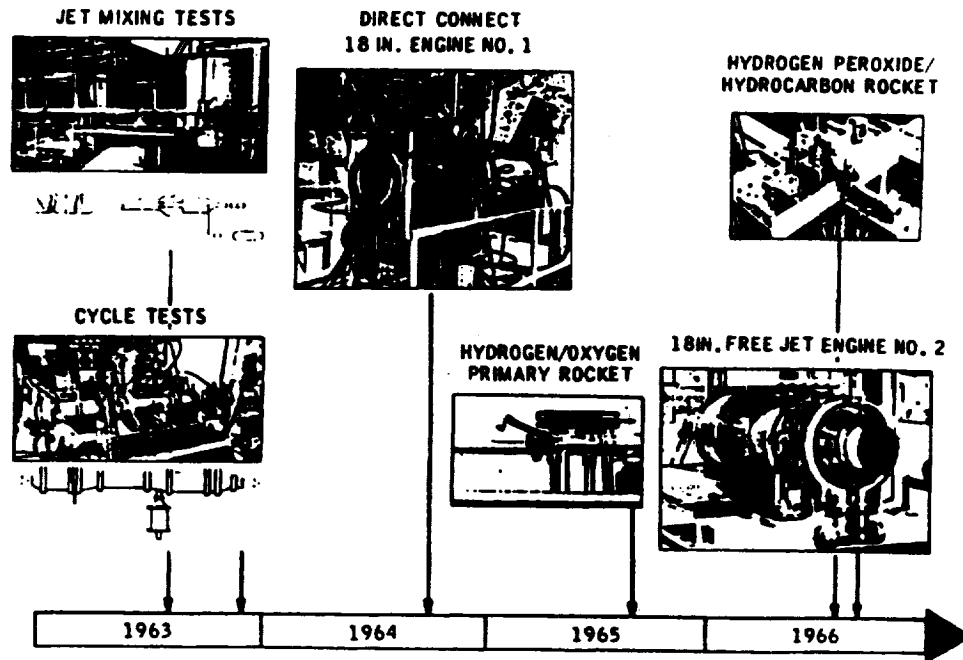

Figure 4: Examples of supercharged ejector ramjet component experimental programs

EJECTOR RAMJET ENGINE ELEMENTS

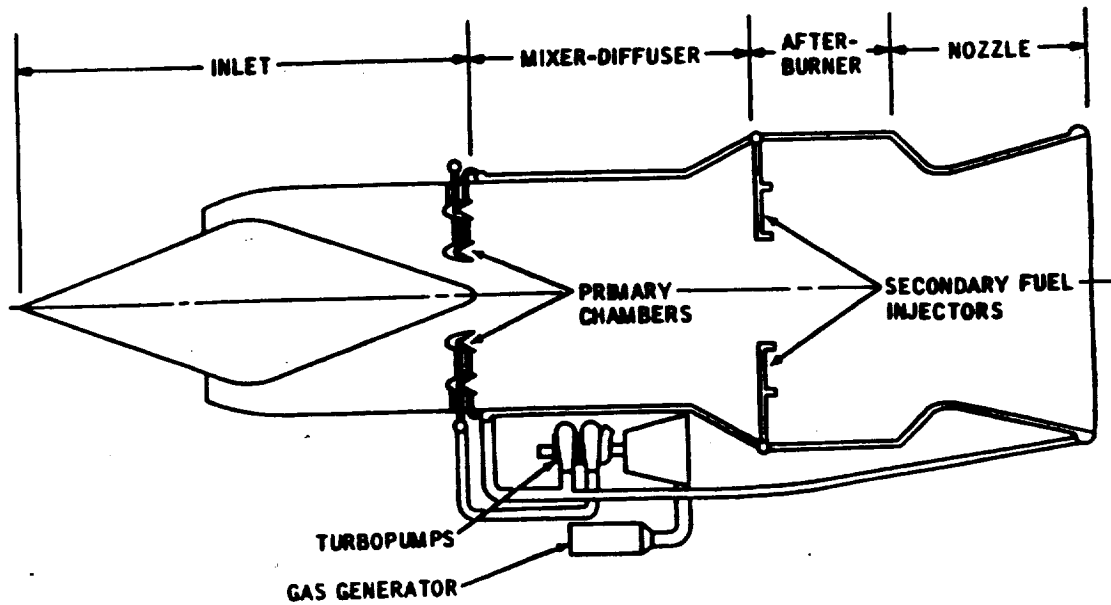

Figure 5: Typical ejector ramjet concept showing major subcomponents

PROPULSION SYSTEM SCHEMATIC (U)

SERJ - 176 ENGINE

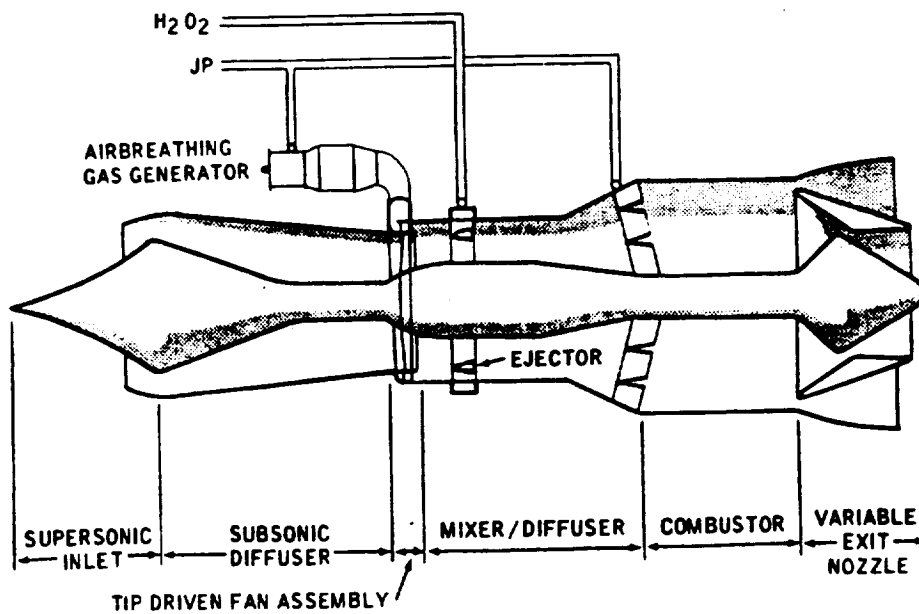

Figure 6: Typical supercharged ejector ramjet engine concept showing major subcomponents

TYPICAL PERFORMANCE TRENDS

HYDROCARBON FUELED ENGINES

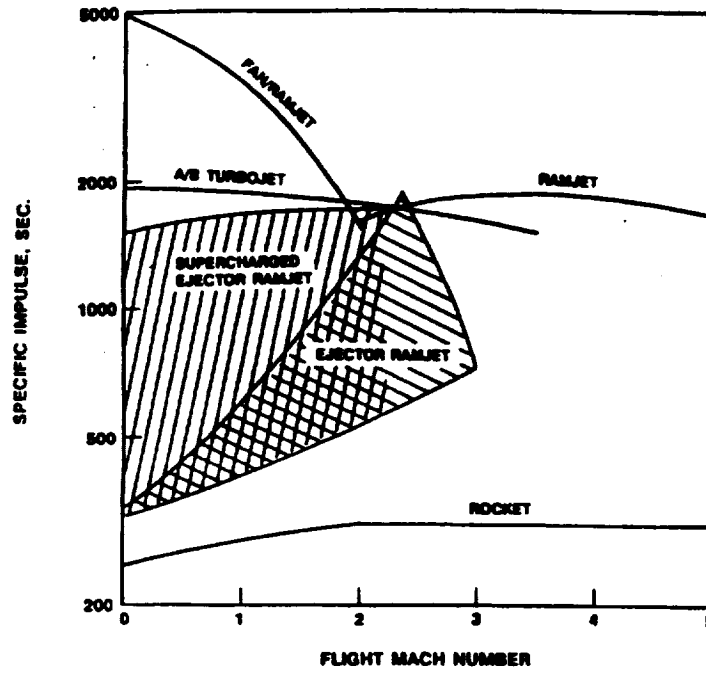

Figure 7: Typical engine performance trends with hydrocarbon fuel

RBCC Propulsion (Representative of Family Engines)

**R. Foster
Astronautics Technology Center
Madison, WI**

(Paper Not Received in Time for Printing)

N 9 2 - 2 1 5 2 8

INLET TECHNOLOGY

Paul Kutschenreuter
General Electric
Cincinnati, OH

1992012286
628260
6p.

At hypersonic flight Mach numbers, particularly above $Mo = 10$, the inlet compression process is no longer adiabatic, real gas chemistry takes on extra importance, and the combined effects of entropy layer and viscous effects lead to highly nonuniform flow profile characteristics at the combustor entrance.

At such conditions, "traditional" inlet efficiency parameters such as defined Figure 1 can be unnecessarily cumbersome and/or somewhat lacking in their ability to appropriately characterize the inlet flow and to provide insight into resulting implications on propulsion system performance. Recent experience suggests that use of Inlet Entropy increase as a hypersonic inlet efficiency parameter has much to offer.

Table 1 illustrates that for a specified value of the inlet efficiency parameter, that scramjet inlet "throat" properties such as are required for use in subsequent propulsion cycle calculations are somewhat easier to calculate when Inlet Entropy increase is used.

As used in high Mach number scramjet cycle calculations, Figure 2 illustrates that the derivative of propulsion system performance with inlet performance tends to be more linear with Inlet Kinetic Energy Efficiency and Inlet Entropy increase. This is helpful in design trade studies.

Figure 3 illustrates the use of Inlet Entropy increase in the Mollier diagram format of Figure 1, except that lines of constant contraction ratio rather than lines of constant static pressure are used. Consequently, continuity is satisfied, which is helpful in parametric studies.

Figure 9 displays a "window of opportunity" on the Mollier diagram as bounded by an upper and lower inlet contraction ratio levels and Inlet Entropy increase. Superimposed are the impact of inviscid shock losses for ideal 3, 4, and 5 oblique shock compression inlet systems. "Viscous & Bluntness Margin" then become the region to the right.

Figure 10 documents that the inlet shock losses are linear only with Inlet Entropy increase. Such linearity is helpful to inlet designers in evolving initial flowpath geometry for specific performance objectives.

Figure 11 illustrates how the previous 1-D approach can be extended to nonuniform scramjet inlet throat profiles by rewriting the conservation equations in boundary layer integral parameter format.

Figure 12 presents parametric hypersonic inlet performance based on this flow profile nonuniformity approach. Note in the first panel that the Inlet Entropy increase is also linear with friction and leading edge bluntness drag losses. Since the conservation equations have been

Table I. Calculation of Combustor Inlet Conditions Compared.

Kinetic Energy Efficiency %	Static Pressure Efficiency %	Process Efficiency %	Compression Efficiency %	Energy Increase $\frac{E_2}{E_1}$
<ol style="list-style-type: none"> 1 $U_2 = \sqrt{\eta_k} U_1$ 2 Guess T_2 3 $A_2 + \frac{U_2^2}{2} \rho_2 = A_1 + \frac{U_1^2}{2} \rho_1$ 4 Guess T_1 5 Guess P_1 6 $U_1 = \frac{U_2 A_2 P_2 \rho_2 T_1}{A_1 P_1 \rho_1 T_2}$ 7 $S_1 \rho_1 = S_2 \rho_2$ 8 $A_1 + \frac{U_1^2}{2} \rho_1 = A_2 + \frac{U_2^2}{2} \rho_2$ 	<ol style="list-style-type: none"> 1. Guess P_2 2. Guess T_2 3 $P_1 = \eta_s P_2$ 4 $U_1 = \frac{U_2 A_2 P_2 \rho_2 T_1}{A_1 P_1 \rho_1 T_2}$ 5 $A_1 + \frac{U_1^2}{2} \rho_1 = A_2 + \frac{U_2^2}{2} \rho_2$ 6. Guess T_2 7. $A_2 \rho_2 = A_1 \rho_1$ 8 $S_2 \rho_2 = S_1 \rho_1$ 	<ol style="list-style-type: none"> 1. Guess P_1 2. Guess T_1 3 $U_1 = \frac{U_2 A_2 P_2 \rho_2 T_1}{A_1 P_1 \rho_1 T_2}$ 4. $A_1 + \frac{U_1^2}{2} \rho_1 = A_2 + \frac{U_2^2}{2} \rho_2$ 5. Guess T_2 6 $\eta_{sp} = \frac{h_2 - h_1}{h_2 - h_{2s}}$ 7. $S_1 \rho_1 = S_2 \rho_2$ 	<ol style="list-style-type: none"> 1. Guess P_1 2. Guess T_2 3 $S_2 \rho_2 = S_1 \rho_1$ 4. Guess T_1 5 $U_1 = \frac{U_2 A_2 P_2 \rho_2 T_1}{A_1 P_1 \rho_1 T_2}$ 6. $A_1 + \frac{U_1^2}{2} \rho_1 = A_2 + \frac{U_2^2}{2} \rho_2$ 7. $\eta_s = \frac{P_2 - P_1}{P_2 - P_{1s}}$ 	<ol style="list-style-type: none"> 1. Guess T_1 2. Guess P_1 3 $U_1 = \frac{U_2 A_2 P_2 \rho_2 T_1}{A_1 P_1 \rho_1 T_2}$ 4 $\frac{S_1 - S_2}{R} = \frac{Q_2}{T_1}$ 5 $A_1 + \frac{U_1^2}{2} \rho_1 = A_2 + \frac{U_2^2}{2} \rho_2$

Figure 2. Specific Impulse versus Inlet Efficiency.

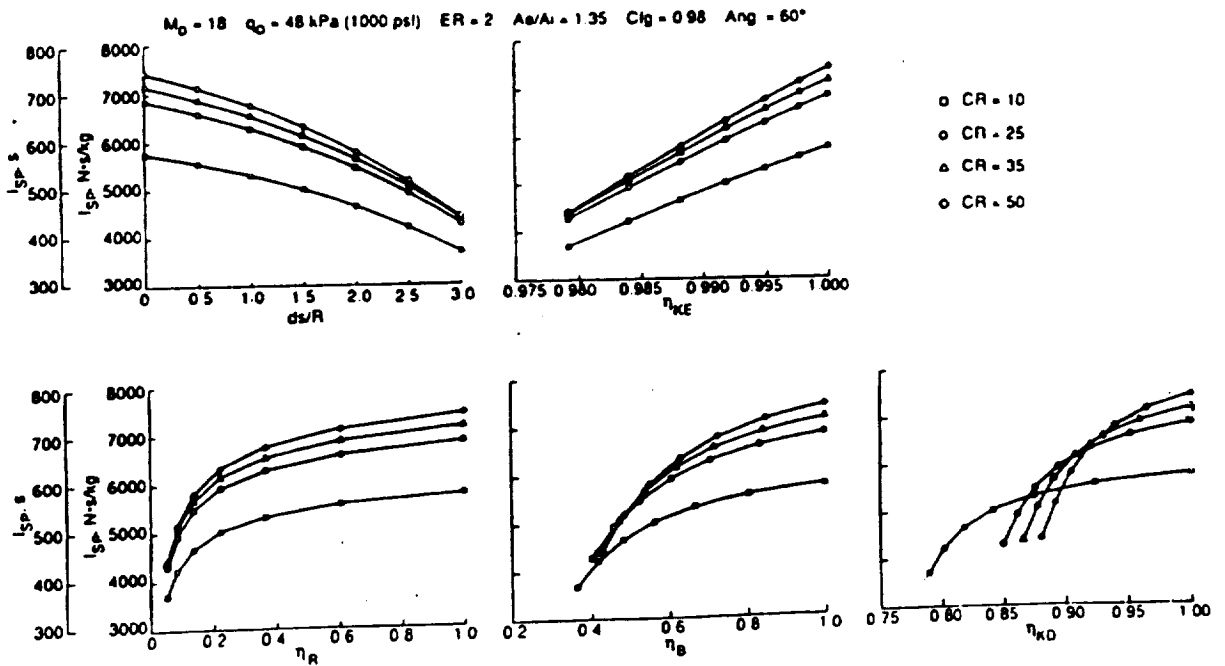

Figure 3. "Mollier" Diagram with Inlet Contraction Ratio Lines.

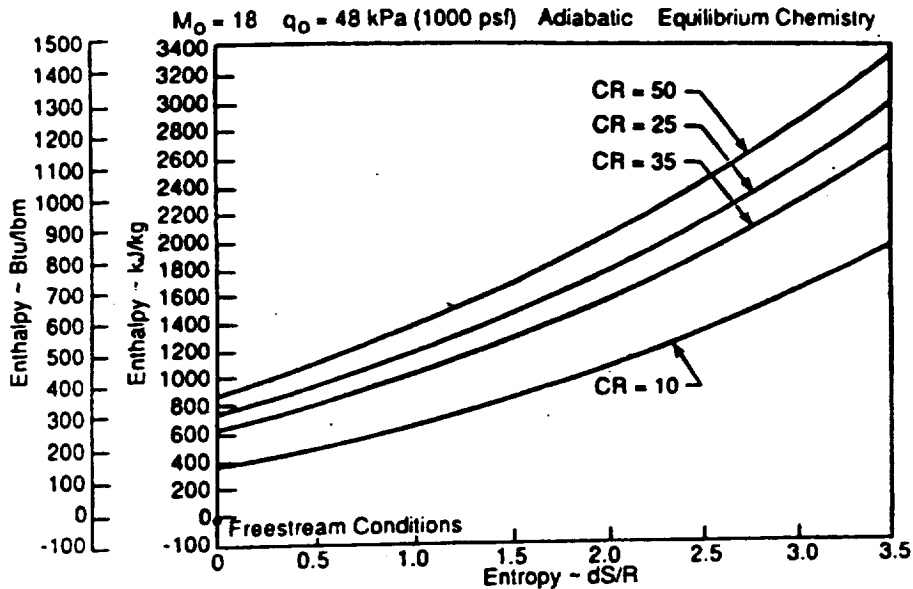

Figure 9. Optimum Shock Inlet Results.

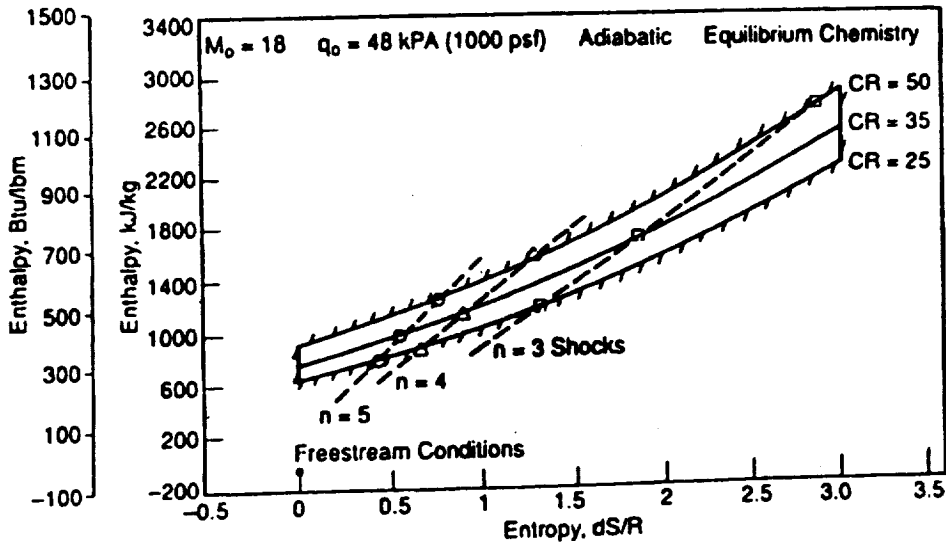

Figure 10. Inlet Parameter Shock Loss Comparison.

$M_0 = 18$ $q_0 = 48 \text{ kPa (1000 psf)}$ $CR = 56.8$ Equilibrium Chemistry
 4 Equal Strength Inlet Shocks
 Reqmi: $dS/R = 1.34$ $\eta_{KE} = 0.9975$ $\eta_R = 0.252$ $\eta_B = 0.653$ $K_0 = 0.92$

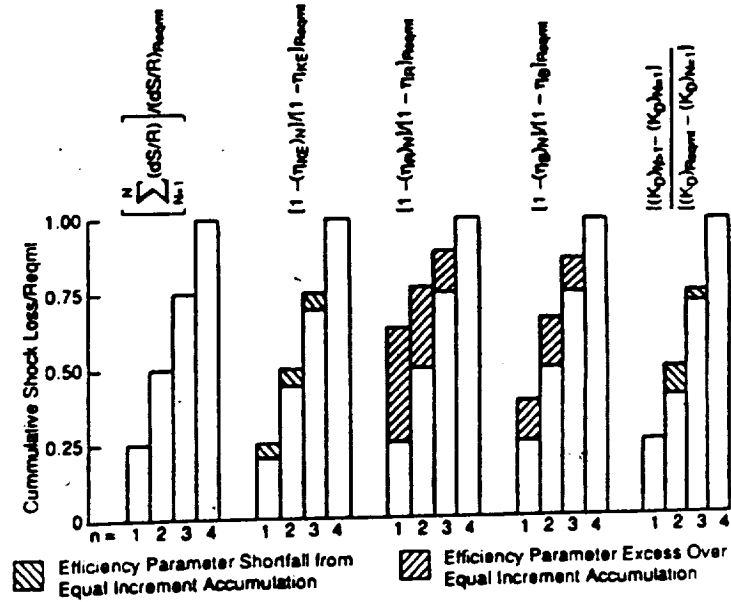
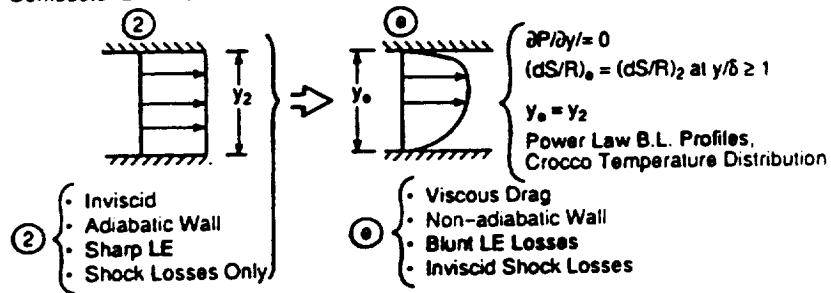

Figure 11. Nonuniform Profile Method with Viscous and Bluntness Effects.

Combusor Entrance Profiles:



Continuity:

$$\delta y_2 = \left[1 - \sqrt{\frac{\gamma_2 T_0}{\gamma_0 T_2} \frac{P_2 M_2}{P_0 M_0}} \right] / (\delta' / \delta)$$

Momentum:

$$P_2 (1 + \gamma_2 M_2^2) - \Sigma \left(\frac{D_{FR} + D_{BL}}{A_2} \right) = P_0 (1 + \gamma_0 M_0^2) - \frac{\delta}{y_2} P_0 \gamma_0 M_0^2 \left(\frac{\delta'}{\delta} + \frac{\theta}{\delta} \right)$$

Energy:

$$y/\delta \geq 1: C_{p_2} T_2 + \frac{U_2^2}{2} = C_{p_0} T_0 + \frac{U_0^2}{2}$$

$$y/\delta < 1: \frac{h_{Loss}}{h_{T_0}} = 1 - \left(1 - \frac{\delta}{y_2} \frac{\delta'}{\delta} \right) \left(1 - \frac{\delta}{y_2} \left[\frac{\delta'}{\delta} + \frac{\theta}{\delta} \left(1 - \frac{h_w}{h_{T_2}} \right) \right] \right)$$

Figure 12. Inlet Performance Nomograph.

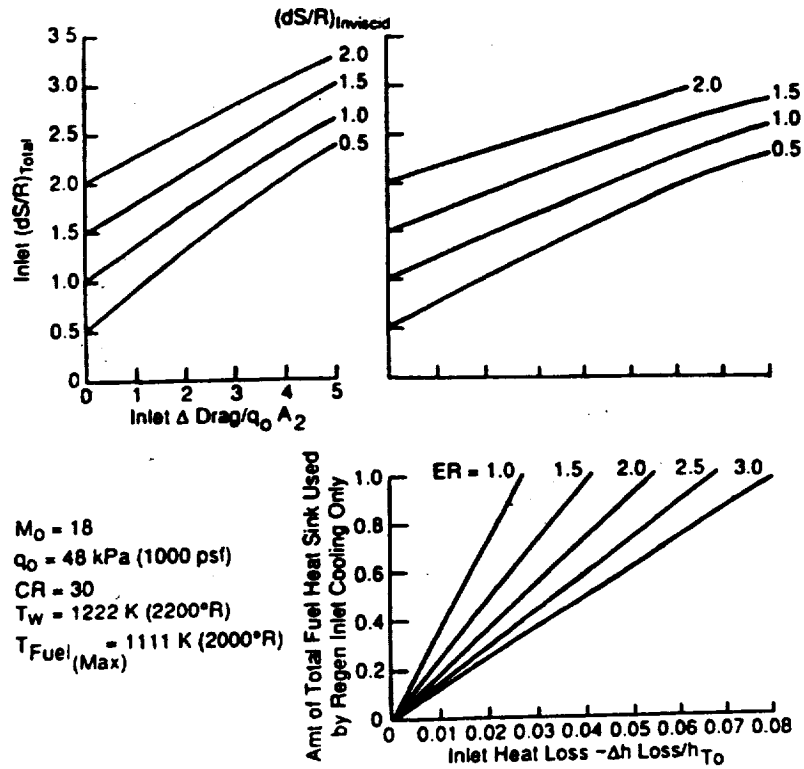
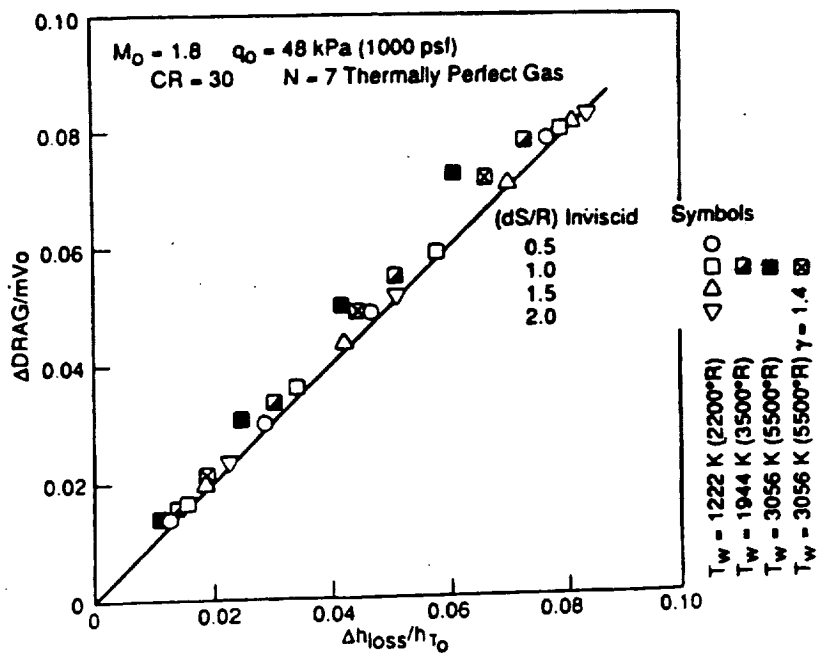

Figure 13. "Modified" Reynolds Analogy Comparison.



N 9 2 - 2 1 5 2 9

H₂-FUELED HIGH-BYPASS TURBOFAN

J. C. Ripley

AiResearch Los Angeles Division
Torrance, CA 90509-2960

1992012287

628262

12p.

INTRODUCTION

In 1976-77, the AiResearch Divisions of The Garrett Corporation,* under contract to the Lockheed-California Company, participated as team members in an effort to evaluate the potential of hydrogen fueled transport aircraft. The work was sponsored by the National Aeronautics and Space Administration, Langley Research Center, and is reported in full in the investigation final report, Brewer¹.

AiResearch developed design concepts and the preliminary design of a LH₂ fueled turbofan engine and of the significant components of the engine fuel delivery and control system. The resulting data were used in the assessment of technical feasibility, size, weight, performance, and direct operating cost. Also, the development which would be required to bring this technology to a state of readiness for design application was defined.

The studies made extensive use of previous work by Lockheed, in which various configurations of LH₂ fueled transports were investigated, Brewer². For the present study, the subject aircraft was a 400 passenger, Mach 0.85 transport, having a range of 5500 nautical miles. This particular aircraft is described in greater detail by Brewer¹.

ENGINE STUDIES

Engine studies were performed to establish a viable baseline concept for the turbofan engine for a LH₂ fueled transport and to assess technical feasibility and impact on aircraft direct operating cost. The investigation phases included:

- Feasibility investigation of various schemes to exploit the special properties of hydrogen, particularly the heat sink capacity.
- Parametric studies to select cycle variables and the engine configuration which minimized direct operating cost. The factors considered in evaluating direct operating cost were specific fuel consumption and engine weight.
- Detailed definition of the selected engine design; including determining engine performance throughout the flight envelope, weight and geometry, scaling laws, engine estimated cost, noise and emission levels, and operating limits and capabilities.
- Assessment of technology development required.

Hydrogen Exploitation

A study was made to determine how the unique properties of hydrogen could be exploited to provide engine performance and/or weight benefits. The concepts which were evaluated are shown schematically on the attached figure. The approach used

*Now divisions of the Allied-Signal Aerospace Company

was to select a turbofan cycle compatible with the aircraft requirements and to investigate the effects of the selected concepts on this baseline. Previous Lockheed work, Brewer², resulted in the definition of a turbofan cycle for a liquid hydrogen-fueled transport, and this cycle was used as a baseline for the hydrogen exploitation feasibility studies.

A summary of the results of the hydrogen exploitation study is included in the attached table. The concepts which yield the largest reduction in DOC are fuel heating and the expander cycle. The fuel heating concept was selected as it is less complex and provides an equal DOC benefit. Hydrogen cooling of the turbine cooling air is also attractive and offers advantages if higher turbine inlet temperatures are selected.

Cycle Definition and Configuration Studies

The cycle definition and configuration studies were accomplished in three phases:

- A review of recent studies of advanced turbofan engines, references 3, 4, 5, to identify and confirm the state-of-the-art, and to establish the technology level expected to be available in the 1990-1995 time period.
- Selection of a preliminary cycle for the LH₂ fueled turbo fan engine, based upon the results of the first phase study, plus other inputs.
- Optimization of the preliminary cycle based upon trade-off studies, including special consideration of a high temperature, high pressure ratio cycle.

The final cycle selected as a result of the hydrogen exploitation studies and cycle selection investigations has the following significant features at the engine design point (maximum cruise power, 10 668 m (35 000 ft) M 0.85):

- Fan pressure ratio of 1.7:1 and a bypass ratio of 10:1
- A booster pressure ratio of 1.45:1
- A compressor pressure ratio of 16.5:1
- A rotor inlet temperature of 1379°C (2514°F) [1482°C (2700°F) maximum rotor inlet temperature]
- A cycle pressure ratio of 40:1

The selected engine is a twin spool, direct drive, separately exhausted turbofan. A single stage fan and two booster stages are driven by a multistage, uncooled, axial turbine. The gas generator consists of a 10-stage axial compressor, a through-flow circular combustor and a single-stage cooled axial turbine. The spool shafts are concentric and the low pressure spool shaft passes through the high pressure shaft.

Four heat exchangers are included as part of the engine to provide (a) hydrogen cooling of the turbine cooling air, (b) engine oil cooling, (c) hydrogen cooling of the aircraft environmental control system air and (d) fuel heating.

Basic cycle and performance data are listed in the attached table.

Technology Development Required

The technology postulated for the LH₂-fueled engine is representative of that which would be incorporated in an engine entering service in the 1990 time period. Much of the technology is not, however, unique to use of LH₂ fuel and will be developed in existing programs. Aerodynamics, materials, mechanical design and manufacturing processes, while advanced, are equally applicable to future kerosene-fueled advanced transport engines. However, technology development is recommended for two items pertinent to the LH₂ fueled engine:

- Combustor
- H₂ cooling of the turbine cooling air

Combustor—Technology development is required to take advantage of the properties of hydrogen and to execute a combustor design which is smaller, provides an improved pattern factor, and is low in oxides of nitrogen emissions.

The design of hydrogen combustion systems is particularly amenable to analysis relative to conventional kerosene combustion systems. The kinetic schemes and reaction rates are well established except for turbulent flow. Therefore, a technology program to develop a hydrogen combustion system would consist of analytical design augmented by an experimental program to establish the turbulent flow kinetics and to verify the analytical design.

H₂ cooling of turbine cooling air—There are two problems introduced when hydrogen cooling of turbine cooling air is incorporated in an engine. The first is a design problem. Normally turbine cooling air is routed internally through the engine from the compressor to the cooled turbine. The routing is different when the turbine cooling air is hydrogen cooled. Complex design problems would have to be addressed but the task could be best undertaken concurrently with engine design.

The second problem is caused by the lower temperature of the turbine cooling air. Thermal gradients in the blades would be more severe than presently experienced for a similar blade heat transfer system. These high thermal gradients can result in low cycle fatigue damage. In order to realize the advantages of H₂ cooling of the turbine cooling air, it is recommended that parallel technology programs be undertaken to

1. Develop heat transfer systems which produce more uniform temperatures
2. Extend development of single crystal turbine blades which have higher cyclic fatigue strength.

ENGINE FUEL DELIVERY AND CONTROL SYSTEM STUDIES:

Three main items were investigated:

- The engine high pressure fuel pump: including preliminary definition of design requirements; identification and tradeoff study of candidate pump and drive systems; special consideration of the pump bearing problem; and selection of a final candidate, followed by further detailed definition.
- The engine fuel control system: including preliminary definition of requirements; identification of candidate systems, followed by a final selection; and preliminary consideration of engine starting and operating procedures.
- The development which would be required to bring this technology to a state of readiness for design application.

These items are illustrated in the attached figures.

Technology Development Required

The study of the engine fuel supply system identified and brought into focus various areas of risk in the technology where advances in the state of the art are either necessary or highly desirable to facilitate the timely and economic development of a flight system. The more significant of these items are:

Engine fuel pump—The engine high-pressure pump bearing system is a major technical risk item requiring advanced development. The current state of the art in advanced high pressure LH₂ pumps has evolved mainly from the development work which has been done on rocket engine turbopumps. As a result of this work, the problems of designing for pump performance (head, flow range, and suction performance), and also the problems of mechanical design and materials selection for cryogenic service, have been adequately resolved and may be considered state of the art.

However, all rocket engine components inherently have a very short mission duty cycle, while air transport equipment has a typical overhaul period of 5000 hours and service life of 40,000 hours. The most critical problem in the development of a high-pressure LH₂ pump suitable for airline service is the pump bearing system, and it is recommended that the approaches described in this report be investigated.

It should be noted that these comments apply only to the bearings of the high-pressure LH₂ pump, which are relatively highly loaded and which operate at high rotational speed. The very lightly loaded bearings of a LH₂ fuel boost pump, which run at lower rotational speed, can probably be developed adequately for airline service as a further evolution of the existing design approach, using rolling element bearings and separators having a dry lubricant capability.

Engine fuel control system—Operation of the cryogenic hydrogen fuel control system presents several new problems such as starting with the supply line full of vapor, the necessity for extremely rapid chill down of the engine high pressure pump, the

probable necessity to control the flow of fuel in both the vapor and liquid states, and the presence of significant volume capacitance in the fuel system combined with the use of the relatively compressible H₂ fuel. These problems make desirable analysis and computer simulation of the selected engine fuel delivery and control system, followed by fabrication and test of a breadboard system.

Overall system—It is desirable to make a preliminary investigation of systems interactions involved in utilizing H₂ as a heat sink for cabin air conditioning, engine oil cooling, engine stator vane and rotor blade cooling, in combination with the engine exhaust fuel heating concept. This may be done initially by computer simulation, and particular attention should be paid to identifying critical off-design conditions.

CONCLUDING REMARKS

The study developed preliminary design concepts for the exploitation of the properties of LH₂ in a turbofan engine intended for air transport use, and showed the benefits which accrue in reduction of aircraft direct operating cost. Design concepts for the engine fuel delivery and control system, including the engine high pressure fuel pump, were developed and general concept feasibility was shown. For both the engine and the fuel delivery and control system, recommendations were made for the advanced development which is necessary to bring the technology to a state of readiness for design application. The study was of necessity abbreviated in nature: more intensive study of both the engine and fuel delivery and control system is recommended.

REFERENCES

1. Brewer, G. D.; et al. Study of Fuel Systems for LH₂ - Fueled Subsonic Transport Aircraft. NASA CR-145369, Final Report Contract NAS 1-14614, Lockheed - California Company, July 1978.
2. Brewer, G. D.; et al. Study of the Application of Hydrogen Fuel to Long-Range Subsonic Transport Aircraft. NASA CR-132559, Final Report Contract NAS 1-12972, Lockheed - California, January 1975.
3. Neitzel, R. E.; et al. Study of Turbofan Engine Designed for Low Energy Consumption. NASA CR-135053, August 1976.
4. Gray, D. E.; Study of Turbofan Engines Designed for Low Energy Consumption. NASA CR-135002, April 1976.
5. Gray, D. E.; Study of Unconventional Aircraft Engines Designed for Low Energy Consumption. NASA CR-135065, June 1976.
6. Scott, R. B.; Technology and Uses of Liquid Hydrogen. Oxford, New York, 1964.
7. Bierman, A. E.; and Kohl, R. C.; Preliminary Study of a Piston Pump for Cryogenic Fluids. NASA Memorandum 3-6-59E, March 1959.
8. Bierman, A. E.; and Shinko, W. G.; Performance of a Piston Type Pump for Liquid Hydrogen, NASA Technical Note D-276, March 1960.
9. Goldsmith, J. S.; and Bennett, G. W.; Hydrogen-Methane Fuel Control System for Turbojet Engines. NASA-CR-121247, General Electric Company.

LH₂ FUEL SYSTEM STUDY FOR SUBSONIC TRANSPORT

- **PROGRAM OBJECTIVE**
 - **EVALUATE POTENTIAL OF HYDROGEN FUELED TRANSPORT AIRCRAFT**
 - **SELECTION CRITERIA AIRCRAFT D.O.C., AND ENGINE SYSTEM WEIGHT**

- **PARTICIPANTS**
 - **SPONSOR: NASA LANGLEY RESEARCH CENTER**
 - **AIRCRAFT STUDIES: LOCKHEED CALIFORNIA COMPANY**
 - **ENGINE AND FUEL SYSTEM STUDIES: GARRETT - AIRESEARCH**

- **TIME OF STUDY: 1976 - 1977**

STUDY APPROACH

- **ASSUME BASELINE AIRCRAFT: 400 PASSENGER, MACH 0.85, 5500 NM RANGE**

- **PERFORM PARAMETRIC STUDIES OF ENGINE CYCLE VARIABLES AND CONFIGURATION TO MINIMIZE AIRCRAFT D.O.C.**

- **IDENTIFY SCHEMES TO EXPLOIT LH₂ PROPERTIES. INVESTIGATE FEASIBILITY AND EFFECT ON AIRCRAFT D.O.C.**

- **ESTABLISH DETAILED DEFINITION OF SELECTED ENGINE DESIGN AND PERFORMANCE**

- **ASSESS TECHNOLOGY DEVELOPMENT REQUIRED**

CYCLE AND INSTALLED PERFORMANCE CHARACTERISTICS - SELECTED LH₂ FUELED BASELINE ENGINE

	SLS, STANDARD DAY	M 0.85 10,668 M (35,000 FT)
POWER SETTING	TAKEOFF	MAX. CRUISE
NET THRUST N, (LB)	135,587 (30,706)	29,100 (6542)
SFC, (kg/hr)/daN ((lb/hr)/lb)	0.1045 (0.1025)	0.2054 (0.2014)
BYPASS RATIO	10.25	10.0
FAN AIRFLOW, kg/sec (lb/sec)	483.7 (1066.4)	217.2 (478.6)
FAN PRESSURE RATIO (TIP)	1.594	1.7
FAN PRESSURE RATIO (HUB)*	2.26	2.466
COMPRESSOR PRESSURE RATIO	15.5	16.5
ROTOR INLET TEMPERATURE, °C, (°F)	1482°C (2700)	1379°C (2514)

*HUB PRESSURE RATIO INCLUDES BOOSTER STAGES

INSTALLATION DRAWING - SELECTED ENGINE

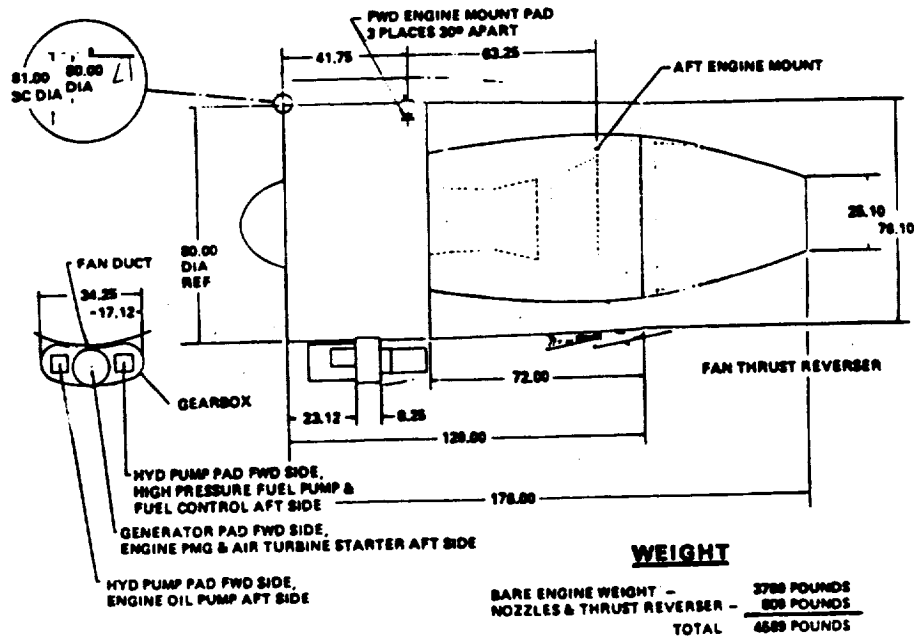

HYDROGEN EXPLOITATION CONCEPTS

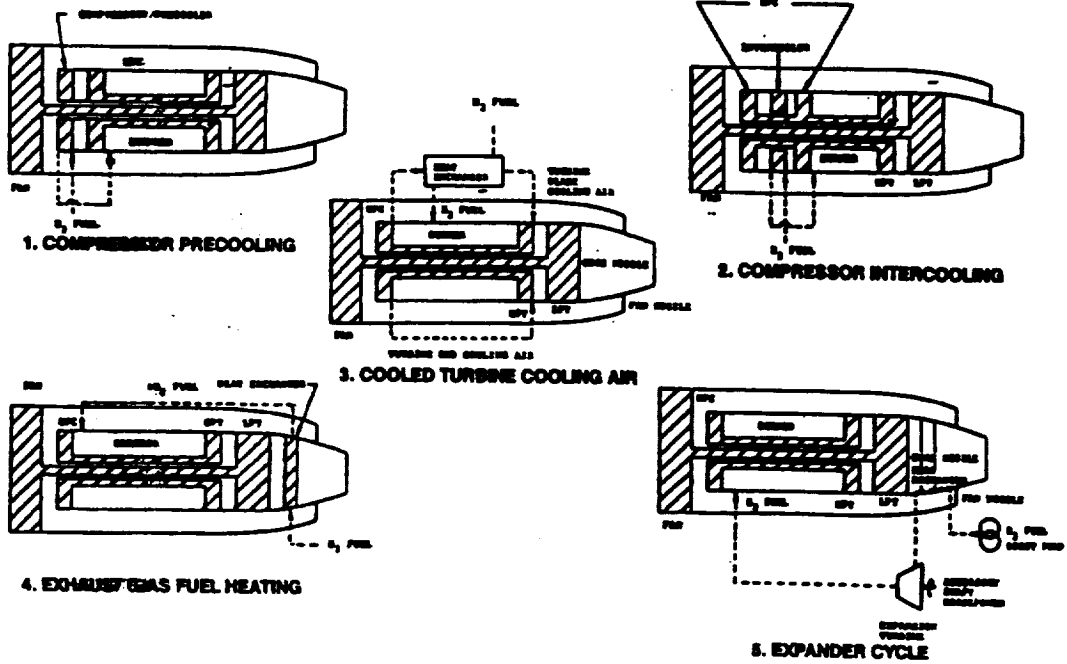

HYDROGEN EXPLOITATION SUMMARY

	η_{12}	ΔP P _{AIR}	ΔSFC^{**} %	ENGINE $\Delta WT, KG$	HX $\Delta WT, KG$	ΔDOC^* %
PRECOOLING	0.8	0.06	-1.86	-63	+75	-1.33
INTER COOLING	0.8	0.04	-0.93	-40	+100	-0.57
COOLED TURBINE COOLING AIR	0.8	N/A	-0.53	-27	+10	-0.41
FUEL HEATING	0.8	0.04	-4.31	+27	+112	-2.90
H ₂ EXPANDER CYCLE	0.8	0.04	-4.31	+27	+112	-2.90

**RELATIVE TO THE BASELINE SFC = 0.2042 ($\frac{LB}{HR}$)/LB

$$*DOC (\%) = \frac{\frac{7.75}{10^6} (\Delta WT) + 1.332 \frac{SFC}{SFC_{BL}} - 1}{DOC_{BASE}} \times 100$$

LH₂ ENGINE FUEL DELIVERY AND CONTROL SYSTEM

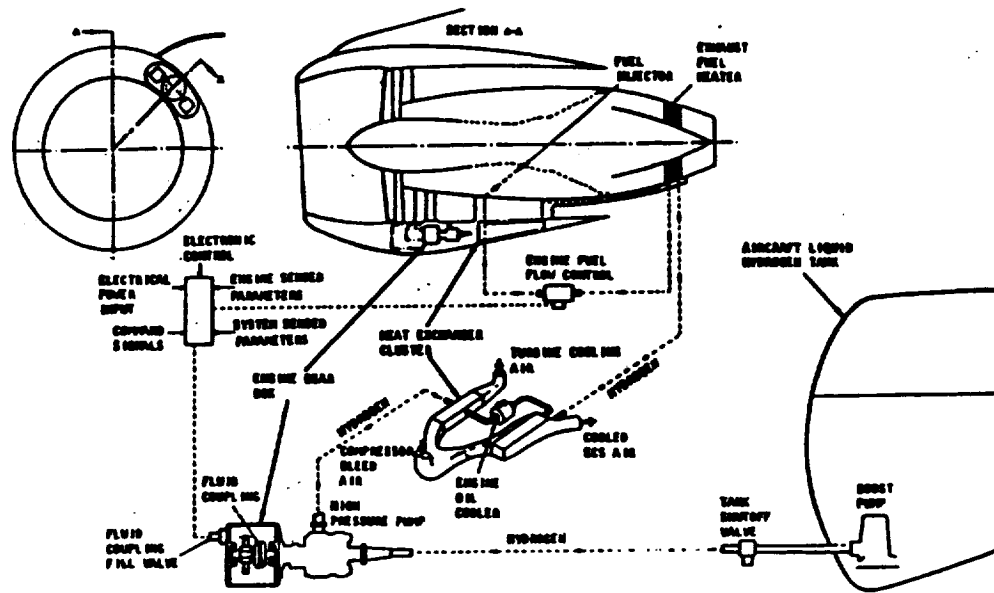

ENGINE STUDIES ENGINE EXHAUST GAS FUEL HEATER

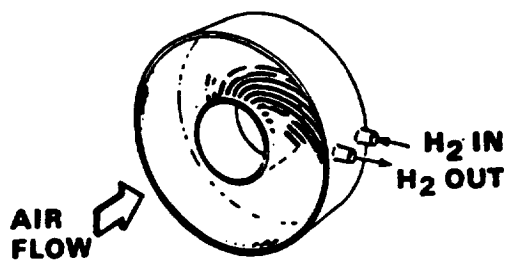

NO. H₂ PASSES _____ 8
 OUTSIDE DIA. _____ 49.8 IN.
 INSIDE DIA. _____ 22.2 IN.
 LENGTH _____ 7.5 IN
 TOTAL WEIGHT _____ 170 LB
 MATERIAL _____ 304 CRES
 TUBE O.D. _____ 0.188 IN
 TUBE WALL _____ 0.012 IN.

ALTERNATIVE ENGINE PUMP DRIVE CONCEPTS

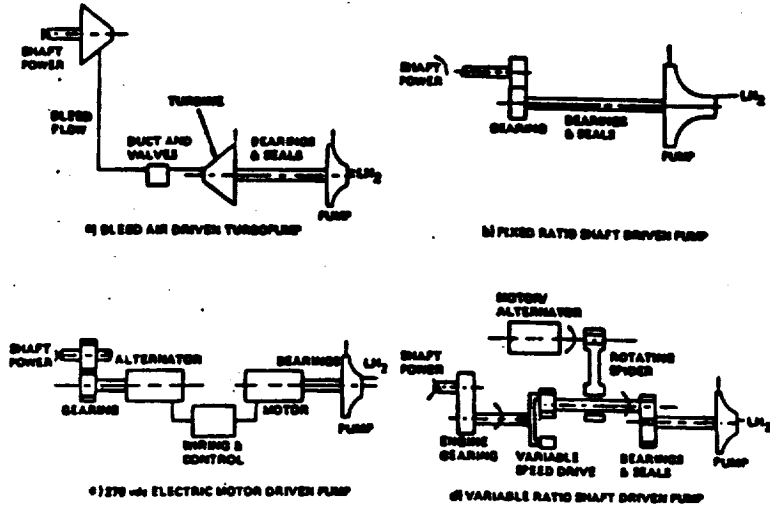

LAYOUT OF ENGINE HIGH PRESSURE LH₂ PUMP

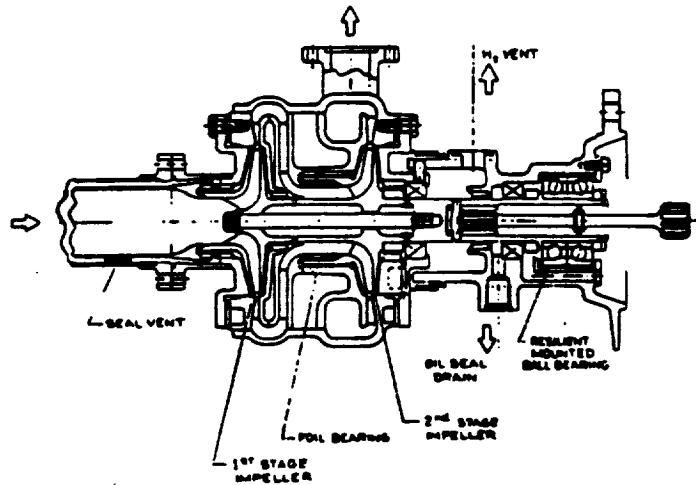

REQUIRED UNIQUE TECHNOLOGY DEVELOPMENT

- **COMBUSTOR DEVELOPMENT TO TAKE ADVANTAGE OF H₂ PROPERTIES**
 - **SMALLER COMBUSTOR**
 - **IMPROVED PATTERN FACTOR**
 - **LOW NO_x EMISSIONS**
- **H₂ COOLING OF THE TURBINE COOLING AIR**
 - **ROUTING OF H₂ THRU THE ENGINE TO COOL THE TURBINE**
 - **ADDRESS THE HIGHER THERMAL GRADIENTS PROBLEM**
- **ENGINE HIGH PRESSURE FUEL PUMP**
 - **BEARING SYSTEM**
- **FUEL CONTROL SYSTEM**
 - **POTENTIAL FOR 2 PHASE FLOW**
 - **SYSTEM VOLUME AND COMPRESSIBLE H₂**

CONCLUSIONS

- **EXPLOITATION OF H₂ PROPERTIES PROVIDES SIGNIFICANT IMPROVEMENT IN AIRCRAFT D.O.C. AND WEIGHT**
- **GENERAL FEASIBILITY OF THE DESIGN CONCEPTS WAS SHOWN**
- **REQUIRED UNIQUE TECHNOLOGY DEVELOPMENT WAS IDENTIFIED**

199201255
628263
N92-21530 10p.

ANNULAR NOZZLE ENGINE TECHNOLOGY

Al Martinez
Rocketdyne Division
Rockwell International
Canoga Park, CA 91303

DRIVER ROCKET SUBSYSTEM

The driver rocket for the combined cycle propulsion system is designed to be compatible with the air augmentation process and to serve as a key element in enabling several of the engine's operating modes: air augmentation, scramjet, and rocket.

For those engines utilizing the on-board air liquifaction process, the rocket subsystem must be capable of operating with liquid air as oxidizer as well as liquid oxygen for the in-space rocket mode.

The power cycle for the driver rocket subsystem could be the simpler and more reliable expander cycle. For cases where more power is required, the gas generator cycle may need to be used.

Annular nozzles are a key element of the rocket driver subsystem.

ANNULAR NOZZLE ENGINE TECHNOLOGY

The annular nozzle concept has been under study since the 1950's. Primary among its advantages is its effective gas expansion in a reduced nozzle length and its better utilization of vehicle base diameter. There are three prominent annular nozzle concepts: the annular bell nozzle, the annular expansion-deflection nozzle, and the Aerospike nozzle. The latter two are obtained respectively from the first through tilting of the throat plane. All three annular nozzles are shorter than the parent and reference circular bell nozzle. They can all be designed to deliver equal flow divergence nozzle efficiency as the circular bell nozzle with the Aerospike nozzle resulting in the shortest length. All three annular nozzle concepts require annular combustors for maximum delivered thrust and therefore require higher coolant flow rates and special design in achieving throat plane thermal stress management.

Extensive effort in design, fabrication and test at Rocketdyne in the years 1955 to 1976 has led to significant advances in the design characterization and utilization of these annular nozzle concepts. The Annular Bell is used in the LANCE missile, 2000 of which have been delivered to the field.

EXPANSION-DEFLECTION NOZZLE

The E-D annular nozzle as it is more commonly referred to has the capability of matching circular-bell design altitude nozzle performance in a nozzle length only 40 percent as long. This nozzle is also capable of providing altitude performance compensation at off-design altitudes through exposure of nozzle base to the prevailing altitude pressure and through gradual recompression on the nozzle surfaces. Seven cold flow models and three hot-firing test configurations have been designed, fabricated and tested at Rocketdyne to characterize the design altitude performance of this concept and its altitude compensating characteristics. Both cryogenic propellants (LOX/H₂) and storable (NTO, UDMH) have been utilized. In addition, the flight characteristics of the nozzle in subsonic and supersonic slipstream have been established. Over 300 tests have been conducted with this concept and numerous design studies completed. A recent design study included a discrete throat area segmented combustor design for the integrated modular engine (IME)

concept. Design applications of this concept project high nozzle expansion efficiencies and high combustion efficiencies traceable to the extensive data base for the annular E-D concept. Some performance penalties do accrue for the discrete throat modification.

AEROSPIKE-NOZZLED ENGINE BACKGROUND

Of the annular nozzles, the most extensively studied is the Aerospike. That is because this nozzle concept is capable of the largest savings in length and because altitude compensation and base thrust augmentation features are more pronounced in this nozzle concept. Circular and planar configurations as well as booster and upper stage configurations have been studied and carried from analysis, to design, to fabrication and test. Approximately \$100 million was spent from 1960 to 1975 to characterize most operational aspects of these nozzles and their application to missiles, space planes, and the Space Shuttle itself.

AEROSPIKE TESTING

Approximately 260 hot-fire tests and 4800 cold-flow tests have been conducted to characterize design point performance, altitude compensation and base thrust augmentation of the Aerospike Nozzle geometries for optimum expansion performance. Injector geometries to maximize combustion efficiency have been established as well as geometries required for combustion stability of cryogenic as well as storable propellants. Extensive combustor segment testing, full scale uncooled and tubular regenerative cooled nozzle testing has provided a wealth of heat transfer data. From this experience, chamber pressure level and thrust level guidelines for efficient cooling of annular reusable Aerospike configurations has been obtained.

Ideal spike nozzle contours were shown to provide excellent expansion efficiency, altitude compensation was corroborated, and the thrust enhancement from bleed flows into the base was proven. Variations of these characteristics with chamber pressure, propellant type, area ratio and nozzle length were established.

LINEAR AEROSPIKE

One more step in the technology demonstration of the Aerospike concept was the testing of a full-scale planar nozzle engine design with J-2 thrust capability and J-2 engine turbomachinery. This engine configuration demonstrated all ignition, combustion stability, injector performance and thrust chamber cooling required at J-2 system pressure levels. The Aerospike thrust chamber consisted of a channel wall segmented combustion chamber construction with tubular wall spike nozzle attachment. Over 73 tests demonstrated high nozzle efficiency, high combustion efficiency, altitude compensation and hardware durability.

THE COMBINED CYCLE ENGINE

The idea that rocket and airbreathing propulsion can be advantageously combined had been proposed since the early 1950's and found application in missiles such as BOMARC and NAVAJO. More recently the concept of combined-cycle integration of rocket/airbreathing engines (taking advantage of other processes such as ejector, air-augmentation, lace-air cycle, supercharging (fan), recycling (H₂), and afterburning) have been advanced to improve overall performance of the two-stage and single-stage-to-orbit vehicles. Rocketdyne has been active in a large number of these areas. The Annular Nozzle concept in the form of a Bell, E-D, or Aerospike has appeared frequently in the combined-cycle engine designs, especially the supercharged ejector ramjet (SERJ) and the scramlace concepts examined by Marquardt Corporation in the late 1960's. Rocketdyne has explored a number of innovative engine concepts in these areas and contributed its resources and understanding of the advanced nozzle design, fabrication, and test experience. Rocketdyne believes there is a promising potential for application of the advanced annular nozzles to the combined-cycle engine concept.

Driver Rocket for RBCC Engine

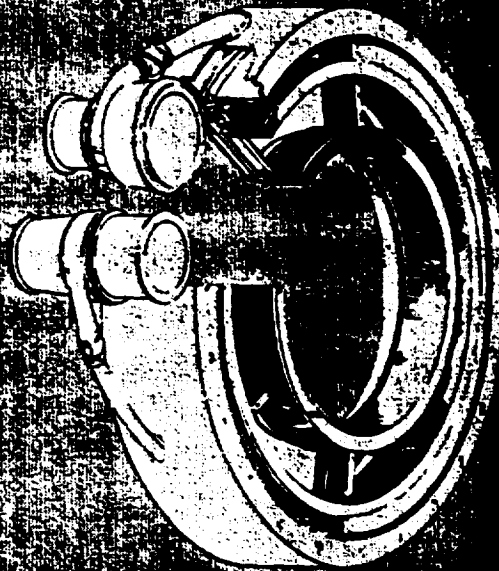

- Turbomachinery
- Hydrogen - high pressure
- LOX/LAIR - high pressure
- Zero NPSH oxidizer pump
- Thrust chamber
 - Annular concentric combustors
 - Annular concentric nozzles
 - LOX/LAIR - hydrogen injectors
 - Discrete axial combustors with annular exits
- Power cycle
 - Gas generator (or) expander

Annular Nozzle Concepts

Annular Bell Expansion - Deflection Aerospike

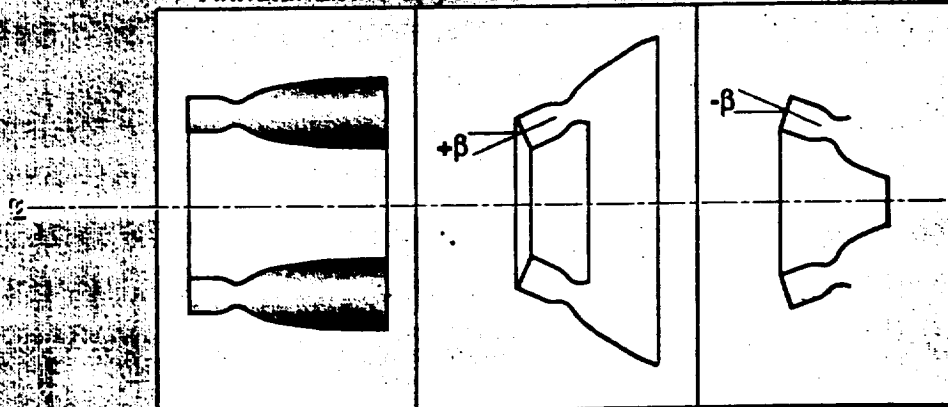

Performance	98.5	98.5	98.5
Length, %	80	40	25
Altitude compensation	Least	Some	Best
Base pressure augmentation	Some	Least	Best

Summary of Rocketdyne Expansion-Deflection Nozzle Experience

Hot Firing

Contract	Thrust	Design Parameters				Propellants	Tests
		α	ϕ	DPD ₁	% P_c		
AFO4811-0808	80K	20	17.00	1,000	20	HTO/MSB	10
AFO4811-0812	10K	20	15.4	3.0	20	O ₂ /H ₂	21
AFO4811-0809	10K	200	27.0	5	40	HTO/MSB	20

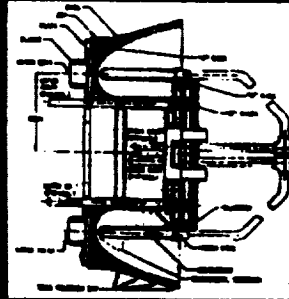

LOX/H2



NTO/A50

Cold Flow

Contract	Thrust	Design Parameters				Test Medium	Tests
		α	ϕ	DPD ₁	% P_c		
AFO4811-0814	67	04.0	3.0	21	100	Air	100
WDA 48-0016-B	25.0	20	3.00	20.7	100	Air	20
WDA 48-0016-C	25.0	24	3.00	20.7	100	Methanol	70
AFO4811-0805	25.0	24	1.291.0	40	20	Air	100
AFO4811-0806	200	200	7	20	1,200	Methanol	20
AFO4811-0870	20-200	200	5-10	10-20	1,200	Methanol	20
10400-4000	(variable)	27.0	2.0	100	100	Air	100



LOX/H2



Design Study



SC820-9-64

Summary of Rocketdyne Hot Fire & Cold Flow Aerospike Test Experience



H₂O₂ (OAK)
43 Tests at AEDC



O₂/RP-1 (OK)
8 Tests at PFA



NTO/A50 (OK)
61 Tests at AEDC



O₂/H₂ (OK)
24 Tests at PFA

Hot Firing

Contract	Thrust	Design Parameters			Propellants	Tests
		α	% P_c	DPD ₁		
APA NASB-10 NASB-200-09	200K	70	11.0	1,800	LOX/H ₂	8
ADP AFO4811-11000	200K	70	20	1,800	LOX/H ₂	14
ER&D-1000	40K	44	20	700	LOX/H ₂	24
AFO411-07-C-0110	20K	200	20	1,000	LOX/H ₂	8
AFO4811-0810	0.4K	20	20	300	NTO-0000	20
AFO4811-0808	0.4K	20	20	300	9% H ₂ O ₂	40
Linear test bed	to 200K	110	20	to 1,200	LOX/H ₂	70

These are selected cases out of a significant data bank (260 tests)



O₂/H₂ (OK)
15 Tests at PFA

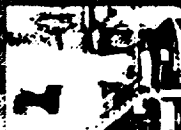

O₂/RP-1 (OK)
8 Tests at PFA

Cold Flow

Contract	Thrust	Design Parameters			Test Medium	Tests
		α	% P_c	DPD ₁		
NASB-0004	25	10	100		Air	100
AFO4811-0870	40.0	20	100		Air	100
AFO4811-0870	100	10	100		Methanol	20
ER&D	20	20	100		Air	100
NASB-0004	Linear 44	20	100		Air	20
SERV	407	5	100		(Methanol)	20
AFO4811-0810	Stochler 20	20-20	100-100		Air	100
SSTO-Rocketd	200	20-20	100		Air	20

These are selected cases out of a significant data bank (4,835 tests)



O₂/H₂ (OK)
44 Tests at PFA



O₂/H₂ (OK)
24 Tests at PFA

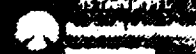

SC820-9-61

J-2 Linear Engine Segment

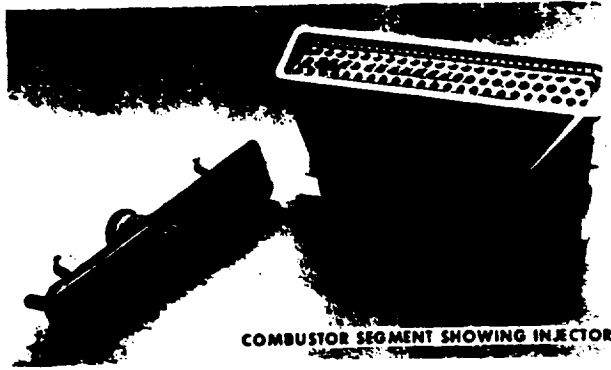
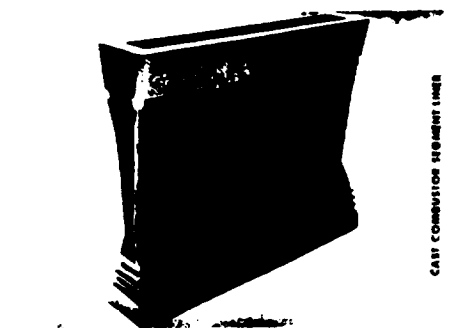
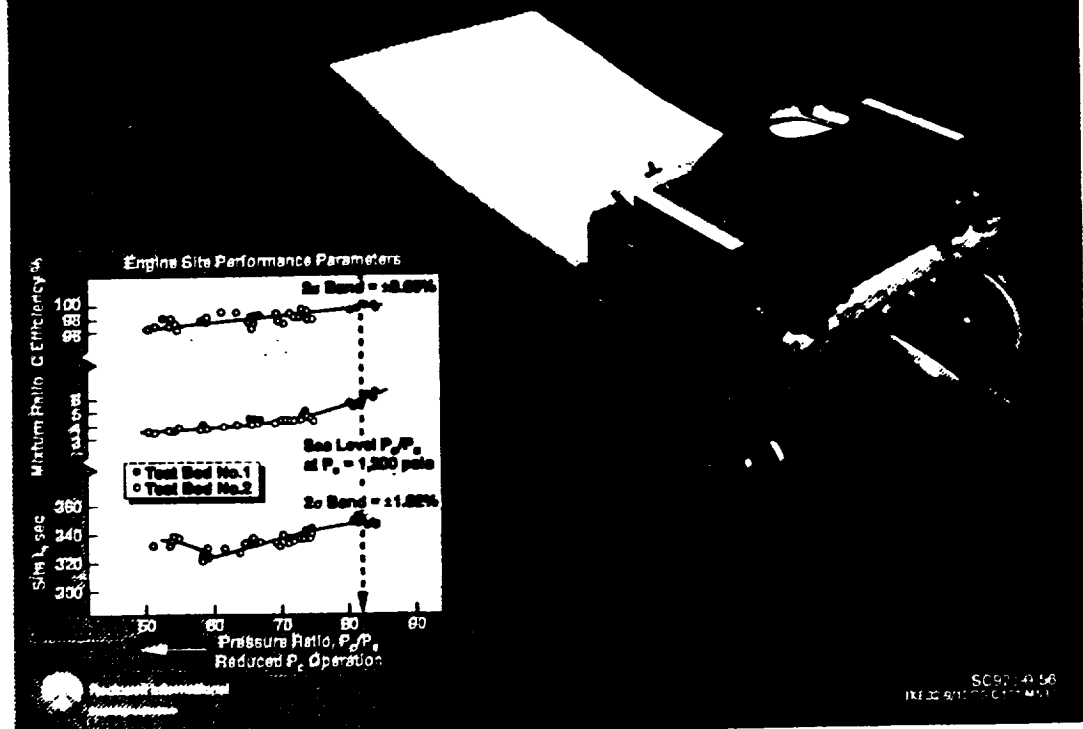

thrust chamber — combustor segment
COMPLETED COMBUSTOR SEGMENT

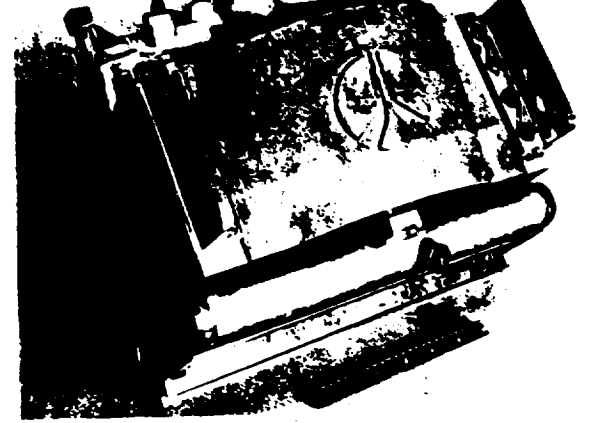
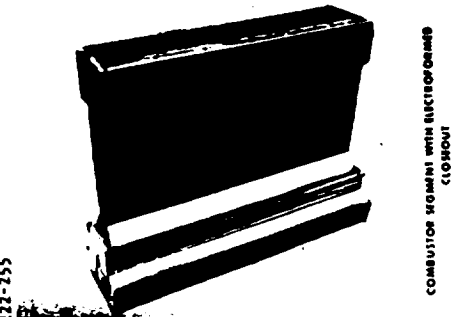

222-255

THRUST CHAMBER-NOZZLE ASSEMBLY

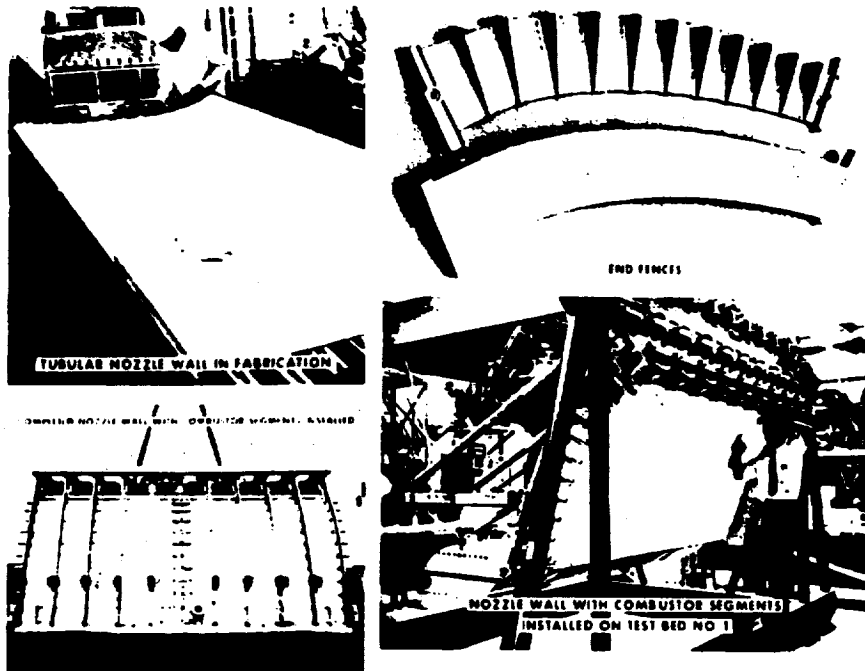

DOUBLE PANEL COOLING CONCEPT

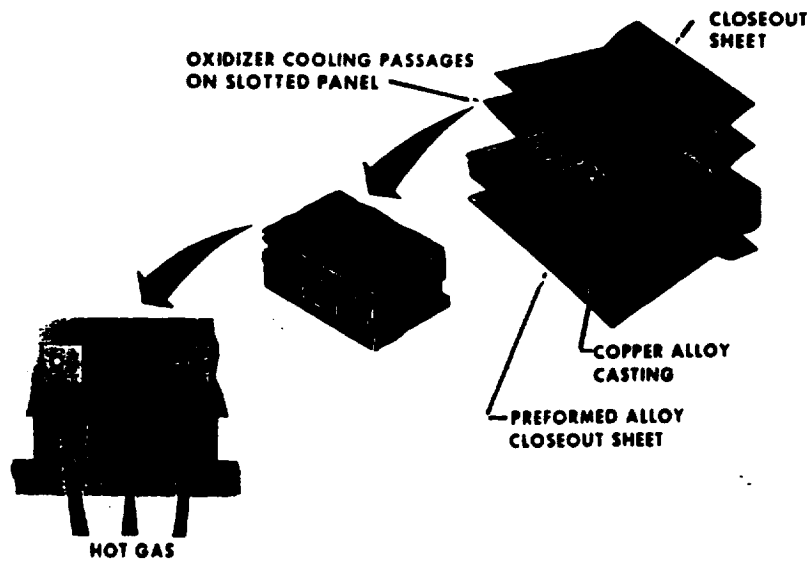

REGENERATIVELY COOLED LIGHTWEIGHT COMBUSTION CHAMBER

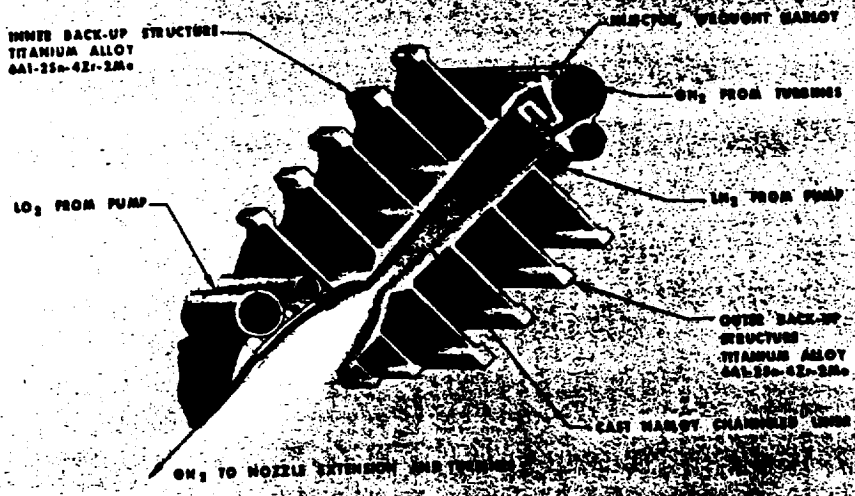

LC30-434A

Rocket-Based Combined-Cycle Engine

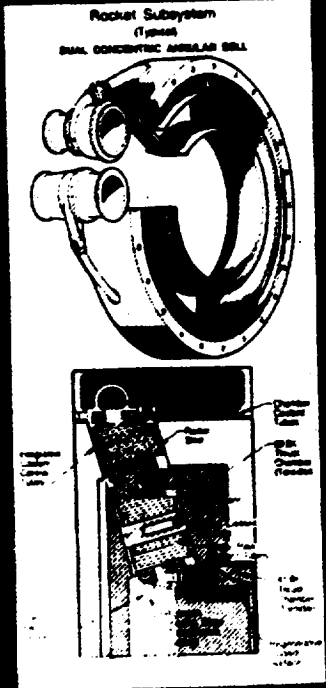
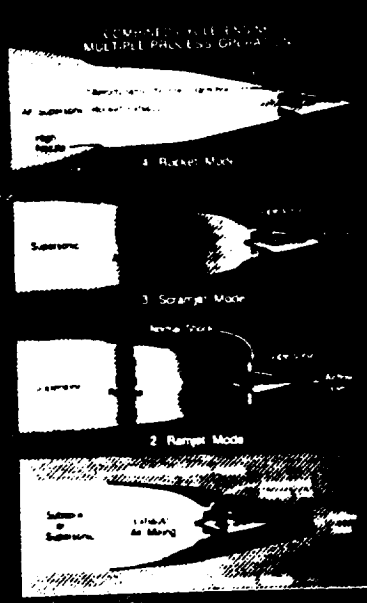

- Supercharged ejector ramjet
- Scramjet engine
- Ejector ramjet

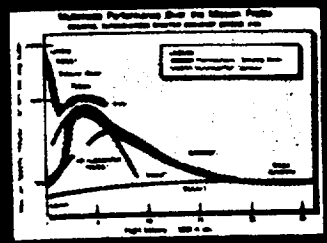

Research Department

SC87C-8-65
M52

ROCKET SUBSYSTEM (TYP.)

DUAL CONCENTRIC ANNULAR BELL

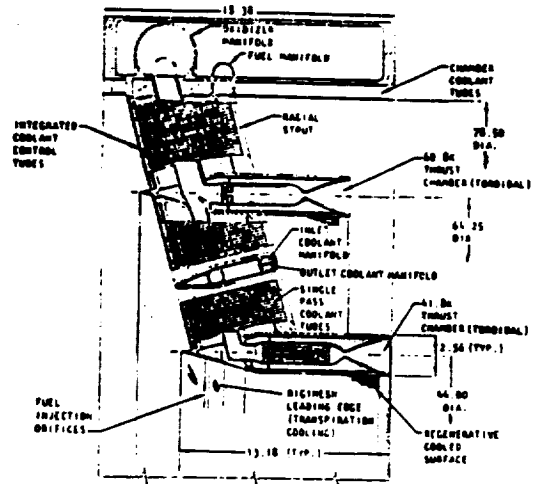
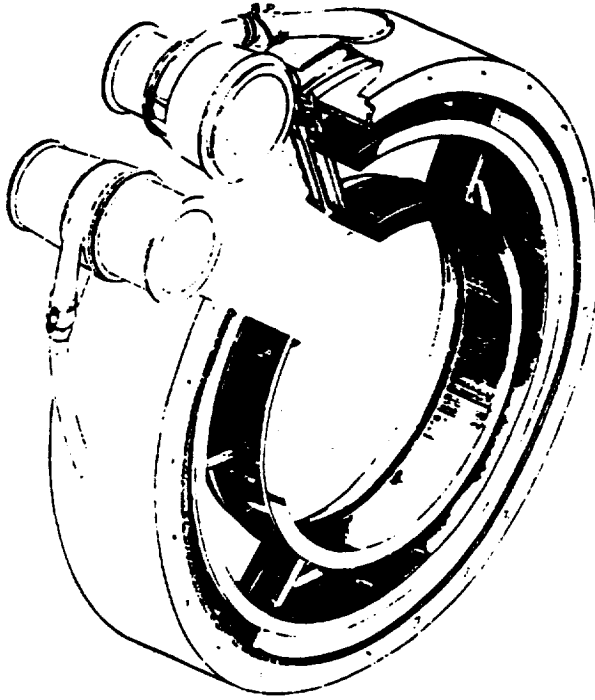

Jet Compressor R&T (Air Augmented)

**F. Herr
Consultant**

(Paper Not Received in Time for Printing)

N 9 2 - 2 1 5 3 1

H₂ Fueled Flightweight Ramjet Construction & Test

Albert Malek
Marquardt
Van Nuys, CA 91406-1739

1992012289
628265
12p.

HISTORICAL BACKGROUND

The "ACES" program began the investigation of regeneratively cooled ramjet engines for propelling aircraft at Mach 6 to 8 flight regimes while collecting and processing air for later use as oxidizer in rocket propulsion into an orbit flight mode. The Marquardt Company had as its prime task the design and demonstration of a ramjet capable of steady state operation using Hydrogen as regenerative coolant and with fuel flow limited to a $\theta = 1$.

Marquardt progressed from shell type combustors to advanced tubular combustion chambers in direct connect test rigs. The first tests were made with water cooled center-bodies and plug nozzles using a pebble bed air heater to simulate flight air temperatures. Later tests were made on completely H₂ cooled flight weight V/G assemblies direct connected to a "SUE" burner heater.

Design studies were also conducted on integrated systems for take-off capability using offset turbojets connected to 2D or axisymmetric inlets. An 18" Hypersonic Ramjet evaluation scale model was designed based on the hot test results using fully V/G inlet and exit nozzle. This thruster would provide 25000 lbs. of thrust with an estimated weight of 250 lbs. A V/G inlet would also incorporate an inlet seal for possible take-off thrust by rocket operation.

HYPERSONIC RAMJET CONSTRUCTION FEATURES

Tubular combustion chambers were built based on thermal fatigue sub-element tests of a variety of hot wall configurations and candidate materials. The final selected tube shape was "D" configuration in Hastelloy X selected for its superior oxidation resistance and fabricability.

Combustion chamber pressure containing structure evolved from strap banding to a Rene 41 wire wrap to utilize the very high strength of the Rene at high temperatures. Several methods were evaluated to optimize the helical wrapping technique. A spacing coil of wire laced with alumina beads was used very successfully on several chambers built.

An inlet seal ring was evaluated in support of V/G inlet sealing evaluations. No further testing was made to improve this device because program directives precluded a test design of the 18" hypersonic ramjet.

THRUST CHAMBER DEVELOPMENT

The initial challenge to successful chamber design was the need to function under the high temperature conditions existing in both the coolant and the structure. This chamber had to be cooled by 1500° R supply H₂ while maintaining a 2000° R hot wall temperature. A heatflux of 3

Btu/in²-sec. in the throat region was more difficult because the V/G nozzle shifted the throat location about 3" as operation ranged from Mach 3 to Mach 8.

Several different chambers were built and tested varying from cylindrical chambers with straight or corrugated hot wall tubes to contoured chambers of two lengths using smooth hot wall "D" tubes. A picture of the early test arrangement of a hybrid system using water cooled innerbody and centerbody with a cylindrical hydrogen cooled chamber as tested at the Marquardt Saugus Test Facility.

1961

Marquardt contracted with Rocketdyne to design and fabricate the first cylindrical thrust chamber. This subcontract was made to utilize their experience in regenerative cooled rocket engines and their proximity to Marquardt. This chamber was made of 1/8 diameter tubes furnace brazed with a strap banding to support pressure loads. This unit was needed for test system shake down operation and did not have a high temperature capability.

1963

Marquardt's initial chamber design was completed using straight corrugated "D" tubes brazed at 2100° F in Marquardt's cold wall vacuum furnace. The braze alloy was Ni-Au-Pd composition that exhibited base metal strength at high temperature. The tubes had a wall thickness of 0.010 and were shaped in a specially designed tool to form the buckles in the hot wall. The tube bundle was held by a closely wrapped wire coil. The tube material was either CRES 321 or Hast C (I can't be sure which). During hot testing analysis requested by WPAFB showed that hot wall bending stresses were excessive due to the outer wall fixity impact on section properties. The new chamber designs would not be subject to this condition because "D" tube with smooth wall and open wrap significantly reduced hot wall buckling and fatigue stresses by reducing the tube wall section dimensions.

1964

The first contoured thrust chamber was built for testing with the water cooled test hardware. It had a long cylindrical combustion section with contoured nozzle. The tubes were "D" shaped Hastelloy X with .010 wall thickness formed with rectangular ends for insertion into Rene 41 supply and discharge manifolds. The tubes were assembled to a Hastelloy X tool and brazed vertically at 2100°F. After the first braze, a Rene 41 Wire and spacing wire with threaded Alumina beads was wrapped together with braze alloy for a second braze at 1950°F using a Cr-Ni-Pd alloy. TIG welding the manifold closures and supply tubes completed the assembly.

1954

A second improved contoured thrust chamber was fabricated featuring a shortened combustion chamber length improved coolant tubes and an Alumina hot wall coating. This unit was destined for assembly into a newly designed V/G fully H₂ cooled ramjet to be tested at Marquardt's cell #2 altitude facility. Hybrid engine testing at sea level with finger injectors

located forward of the centerbody showed that chamber length could be shortened and injection moved aft to the centerbody exit. This reduced the overall heat load to the engine without affecting performance.

Contoured chamber coolant tubes were formed by a propriety process developed by the Lefiell Company of Santa Fe Springs, CA. This process called "Roto-Draw" was SOTA for CRES tubing used in large rocket thruster of that period. This tube of Hastelloy X was LeFiell's first experience into superalloy tube forming. "Roto-Draw" changes the tube circumference without changing its wall thickness. A contoured D tube can be made from a varying round tube whose perimeters exactly match the dimensions needed for a contoured shape. The D shape is made in a split die under very high hydraulic internal pressure. Metallurgical examinations showed that the forming introduced large intergranular cracks and surface discontinuities. Intensive metal processing finally corrected the deficiencies to result in a tube wall with almost perfect intergranular structure and surface finish.

1967

Other elements of the V/G ramjet were four (4) strut assemblies made of brazed INCO 718 structure and machined rib type coolant walls made of Hastelloy X. After brazing, the tree subassemblies were welded together. These struts carried the plug nozzle pressure loads and provided the access for internal cooling, control and instrumentation for the plug nozzle actuation.

Several plug nozzles were designed and fabricated:

1. A shell type nozzle with machined ribs to support a brazed hot wall shell.
2. A transpiration cooled nozzle with sub-surface compartments to control the flow of coolant.
3. The final nozzle design consisted of 0.010 thick Hastelloy X formed "U" channels brazed into machined grooves of the conic plug structure. This assembly was also given an Alumina insulating coating.

1966-1968

The partially assembled thruster called a "Component Development Rig" shows the center body, the two concentric fuel injector rings, the plug nozzle and the instrumentation hookup needed for the actuator and the plug closure.

A test at the Saugus facility is shown with an uncoated chamber showing a high temperature ring where separation occurs at sea level operation.

The test installation in the cell #2 altitude chamber is shown with the torus H₂ supply manifold to control coolant and fuel flow independently for development reliability only.

The completed Ramjet development engine is shown after testing with improved contoured chamber installed. This assembly weighed 170 lbs. dry and featured a controlled plug nozzle to operate between Mach 3 to 8. Maximum chamber pressure was 250 psia. with hot wall temperatures limited to 2000°R. This assembly had over 3 hours of test time with many tests exceeding 10 minutes duration. The engine is stored in Marquardt's museum.

1965-1966

Interest in Scramjet technology funded the evaluation of a 2D Scramjet-Inlet/Combustor model. Marquardt designed and fabricated the Scramjet shown with using the tube forming and brazing background developed for the hypersonic ramjet as the basic design approach. The unique feature of this design was the use of a newly developed high temperature Hafnium-Tantalum Alloy by Ken Marnoch of Marquardt's material group that demonstrated stability when exposed to rocket discharges of temperatures over 5000°F. Samples of this material had just been tested, when the decision time for a leading edge was required. This material generates an oxide surface that prevents further degradation of the base material. Samples were successfully tested in a simulation of the actual Scramjet installation. The leading edge radius was 0.060" with a taper angle of 30°.

SUMMARY

Technologies developed and laid to rest include:

1. High temperature brazing methods and the importance of a cold wall vacuum furnace for temperature control.
2. Hastelloy X tube material processing & treatment.
3. The use of a Plasma sprayed metal-ceramic insulating hot wall coating to reduce the effects of localized overheating in nozzle throats.
4. High strength open helical wire wrap to reduce the thermal compressive stress on hot walls and thereby increase fatigue life.
5. "D" tube hot walls especially in high heat flux regions to reduce thermal stress and increase tube fatigue life.
6. Hot wall static pressure and thermocouple instrumentation techniques.
7. Very high temperature small radius leading edge potential.

REGENERATIVELY COOLED COMPONENTS

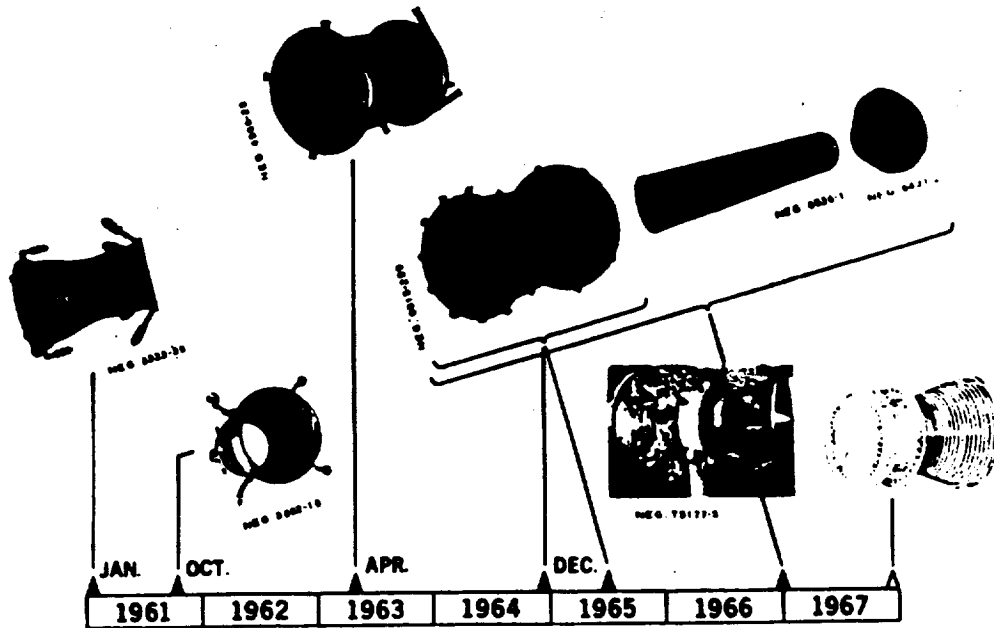

HYPERSONIC RAMJET STRUCTURES

THE STRUCTURAL EVALUATION OF COOLANT TUBES WITH SIMULATED STRESS TO BUCKLING UNDER THERMAL FATIGUE LOADING IN THE PLASTIC RANGE.

- EVALUATION OF- CORRUGATED VS STRAIGHT TUBING
 "D" SHAPES AND ROUND CONFIGS.
 EFFECT OF R/t RATIOS (10-50)
 COMPARISON OF HIGH TEMP ALLOYS
- SIMULATION OF ENGINE ENVIRONMENT
 MAX. HOT WALL TEMP.
 ΔT - HOT AND COLD TEMPS.
 SIMULATED BENDING RESTRAINT/CLASSICAL BUCKLING
 THERMAL CYCLING FATIGUE LIFE

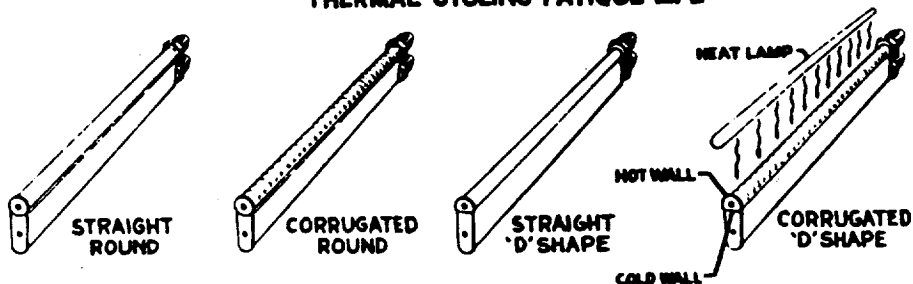

HYPERSONIC RAMJET STRUCTURES

RESULTS OF STRUCTURAL THERMAL TEST OF COOLANT TUBES

TYPICAL TEST PRODUCTS (AVERAGE)

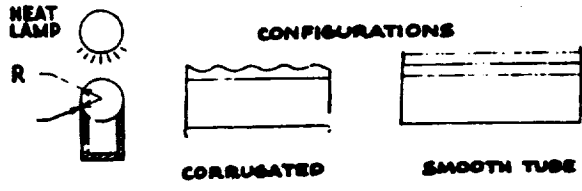

MATL.	CONF	R/t	TIME	ΔT	CYCLES	MODE
321SS	S/C	16.5	1200	1000	260	NONE
321SS	S	25	1200	1000	68	BUCK-FRT.
HAST C	S/C	16.5	1200	1000	260	NONE
321SS	S	10	1700	1400	260	NONE
321SS	S	16	1700	1400	170	BUCK-FRT.
321SS	S	25	1700	1400	14	BUCK-FRT.
321SS	C	16.5	1700	1400	95	FATIGUE
HAST C	S	16.5	1700	1400	125	FATIGUE
HAST C	C	16.5	1700	1400	60	FATIGUE
RENE'41	S	16.5	1700	1400	60	FATIGUE

CRITICAL BUCKLING TEMPERATURE GRADIENT VS. COOLANT TUBE RADIUS THICKNESS RATIO

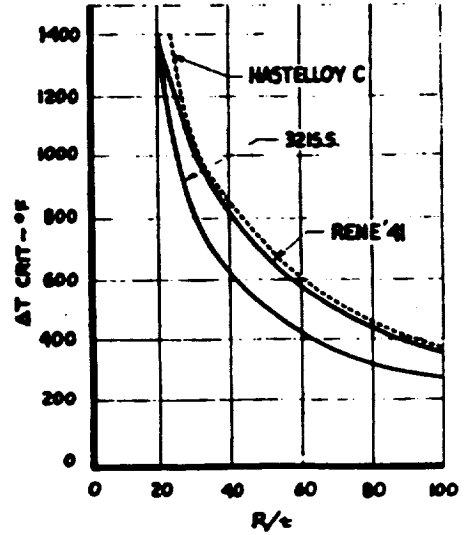

HYPERSONIC RAMJET STRUCTURES

THE DESIGN MFG & TEST OF A THERMALLY ACTUATED INLET VALVE SEAL FOR H/J TRANSITIONAL MODE CAPABILITY

- SEALING - THERMAL RESPONSE - PRESSURE FRICTION - LIGHT WT. - FLEXIBLE - OB ROUND & ECCENTRIC COWL
- CONTROL - STRAIN SENSING - COOLANT TEMP CONTROL

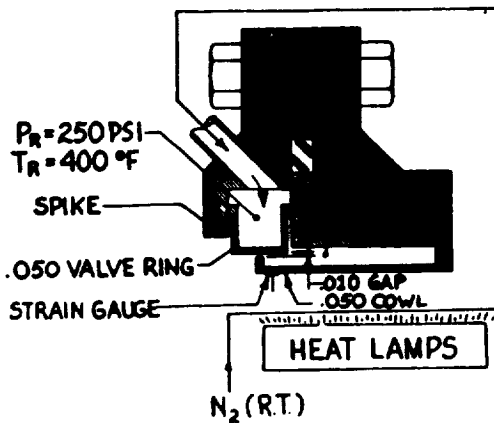

OBJECTIVES

- DETERMINE μ
- ΔR vs P_R
- ΔR vs $P_R + T$
- RING CENTERING CAPABILITY

RESULTS

- μ - .132
- .002 PER 100 PSI
- .008 PER 100 PSI + 100°
- ACCOMPLISHED
- FRICTION NOT RESTRAINT

RECOMMENDATIONS

1. IMPROVED SURFACE MATL. & FINISH
2. HEATING TECHNOLOGY
3. CONTINUED DESIGN & EVALUATION

HYPERSONIC RAMJET STRUCTURES

THE DESIGN / MFR. OF A FLIGHT WEIGHT, REGEN-COOLED, 18" DIA THRUST CHAMBER FOR COMBUSTION TESTING - WITH COOLANT TEMP. CYCLING CAPABILITY, USING RENE 41 PRIMARY STRUCTURE

- TEST CONDITIONS
 - GAS FLOW 40 PPS
 - CHAMBER PRESSURE 150 PSIA
 - GAS TEMP. 4,500°R
 - H₂ COOLANT FLOW 4 PPS
 - H₂ COOLANT PRESS. 500 PSIA
 - H₂ COOLANT TEMP. 570°R
 - HEATFLUX $\frac{3}{2}$ BTU/IN² SEC. } THROAT
 - MAX. HOT WALL 2,000°R
- STRUCTURAL DESIGN LIMITATIONS
 - 250 P_c
 - 2000°R MAX. WALL TEMP.
 - 1500°R H₂
 - 600 PSI H₂
- ADVANCED TECHNOLOGY
 - TUBE DESIGN FOR INCREASED LIFE + MULTI-MODE FUNCTION
 - STEP BRAZING TECHNIQUES-ADVANCED ALLOYS
 - MFG. DEVELOP. - "D" TUBES/RENE 41 WRAP
 - LIGHT WEIGHT FLANGE + MANIFOLD CONCEPTS

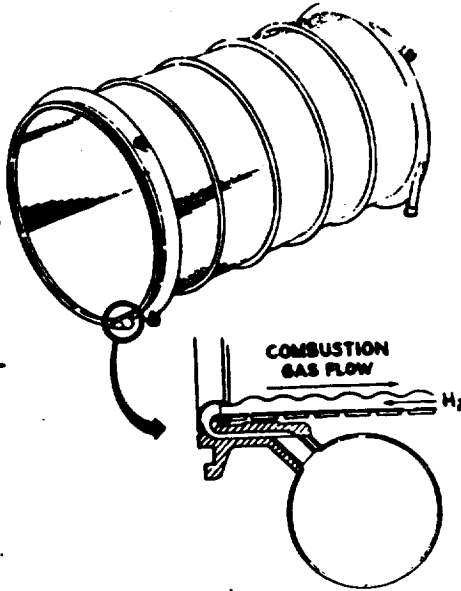

HYPERSONIC RAMJET STRUCTURES

LT. WEIGHT 18" DIA. THRUST CHAMBER

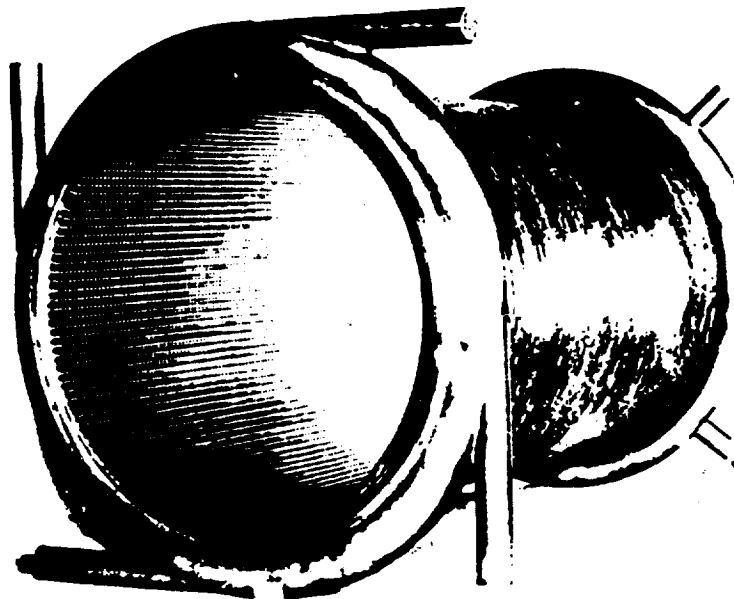

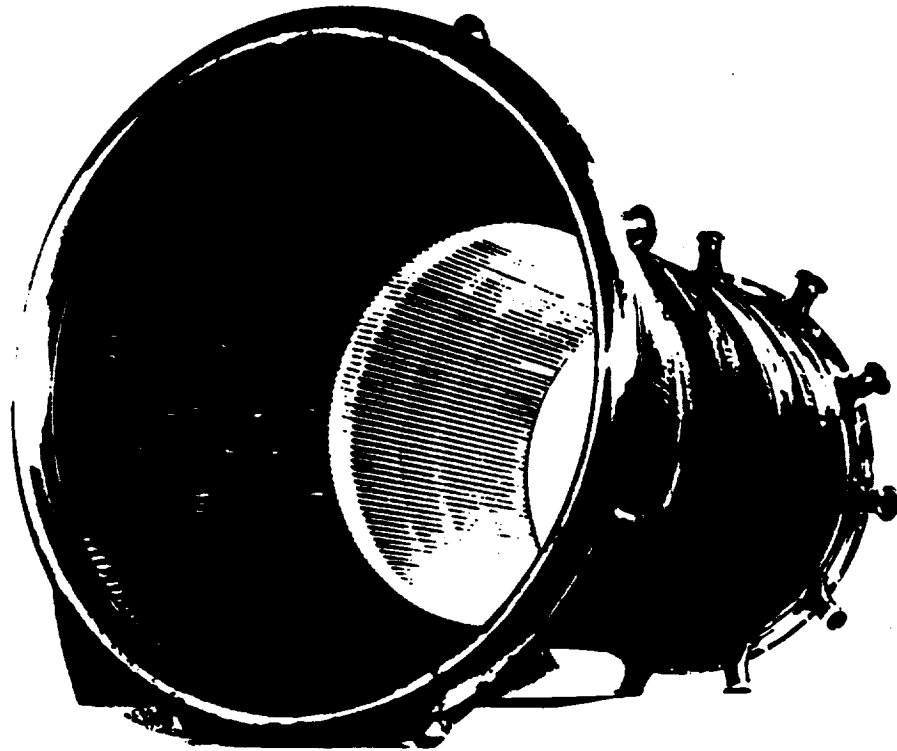

18" REGENERATIVELY COOLED THRUST CHAMBER
25 NOV 64 (U)

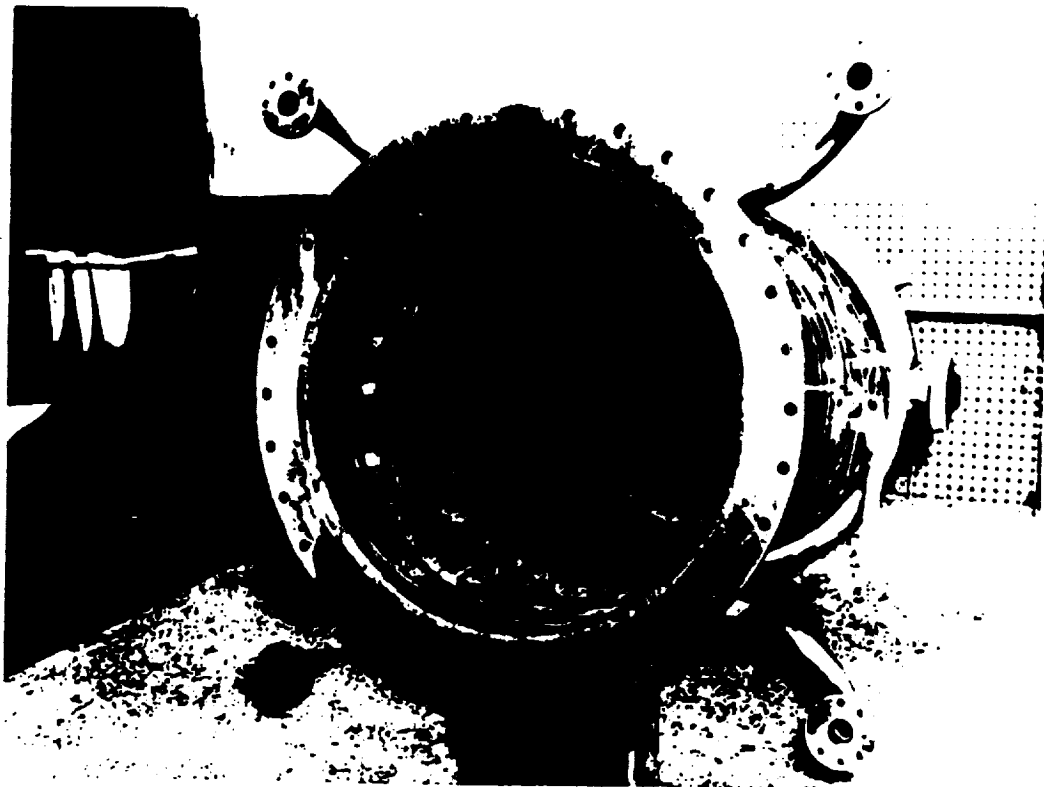

ROCKETDYNE 18" REGENERATIVELY COOLED THRUST CHAMBER
9-28-61

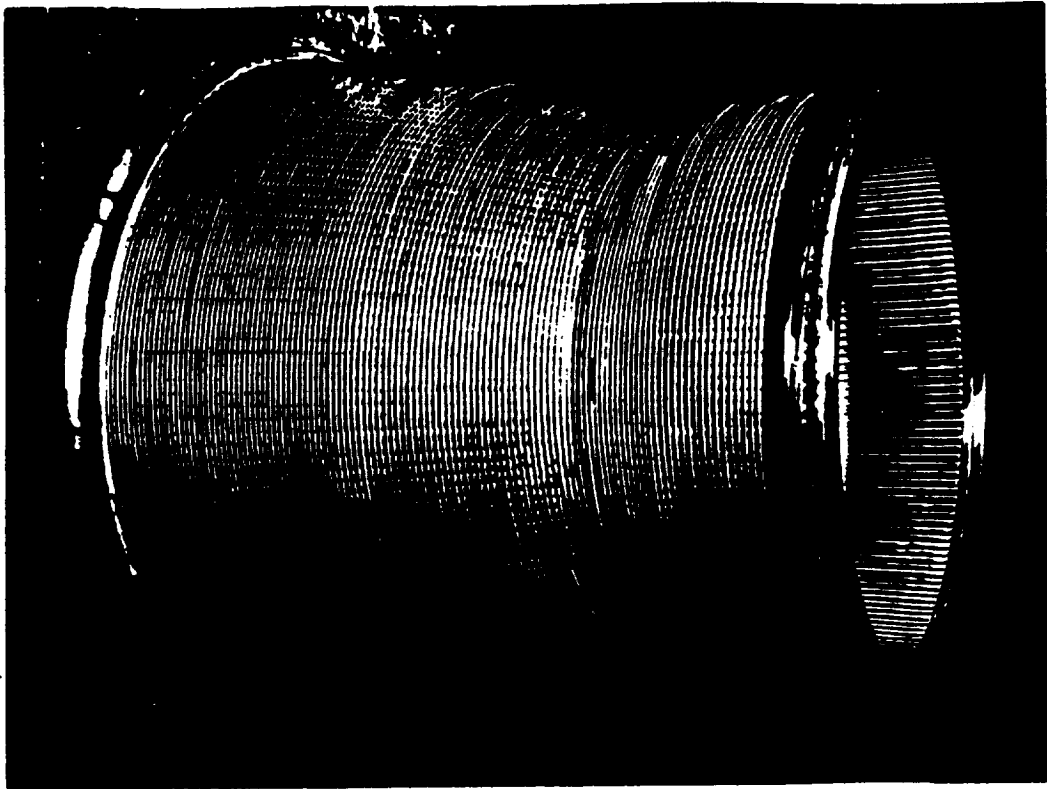

CONTOURED CHAMBER NO. 2 AFTER BRAZING RENE '41 WIRE
31 MAR 65 (u)

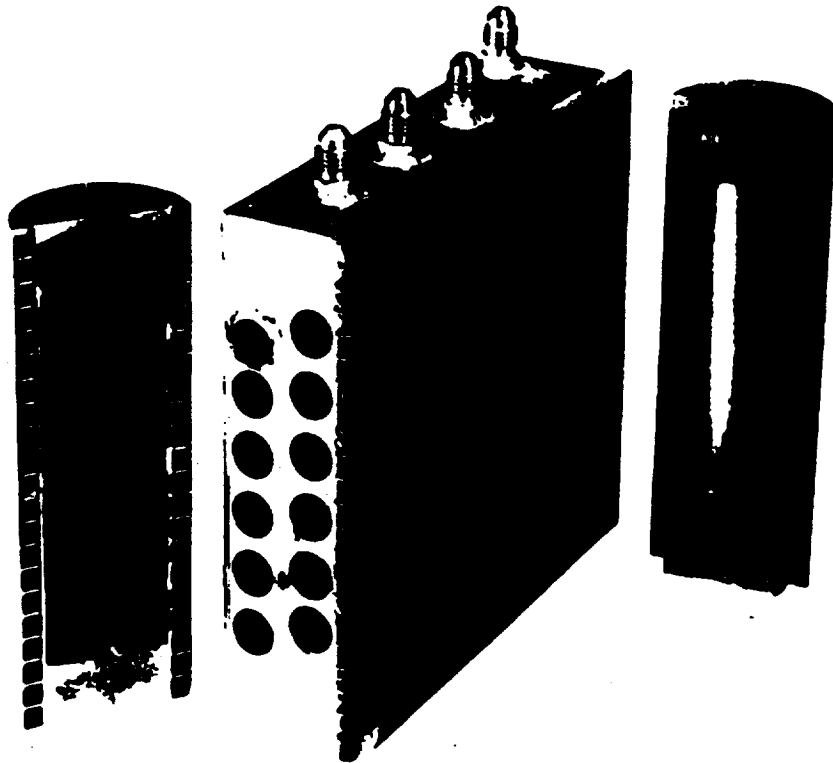

CENTERBODY STRUT COMPONENTS AFTER BRAZING HOT WALL SKINS
20 JUL 67

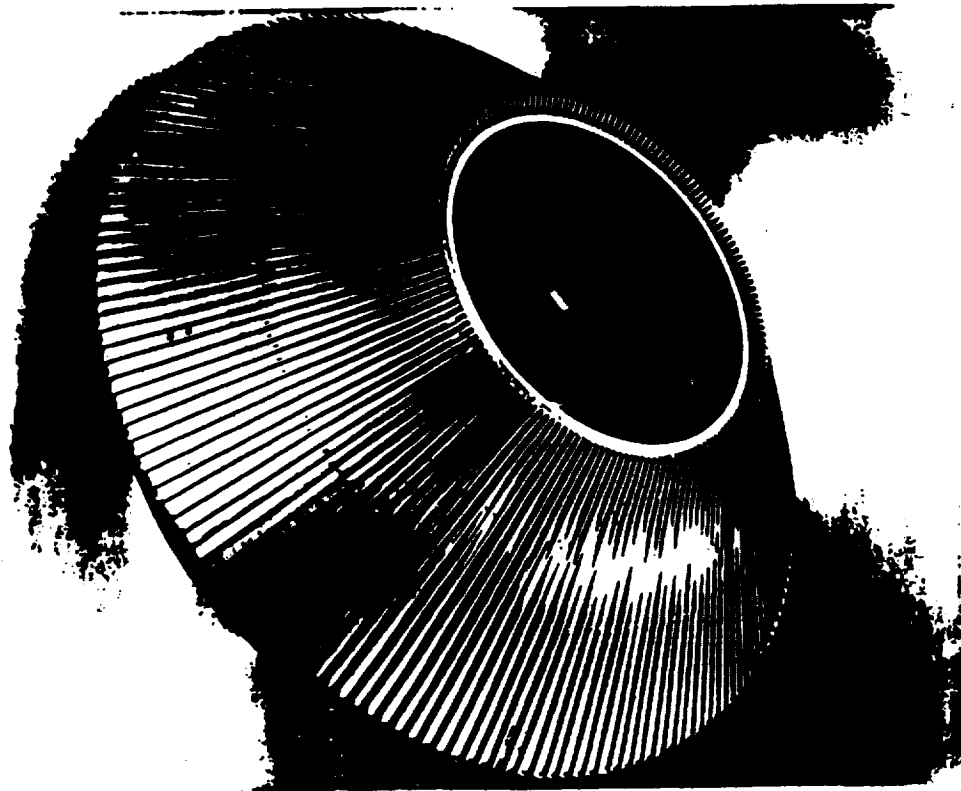

EXIT NOZZLE PLUG
RID WALL BEFORE HOT WALL INSTALLATION



TRANSPARATION COOLED EXIT NOZZLE PLUG--FRONT VIEW
24 NOV 64 (U)

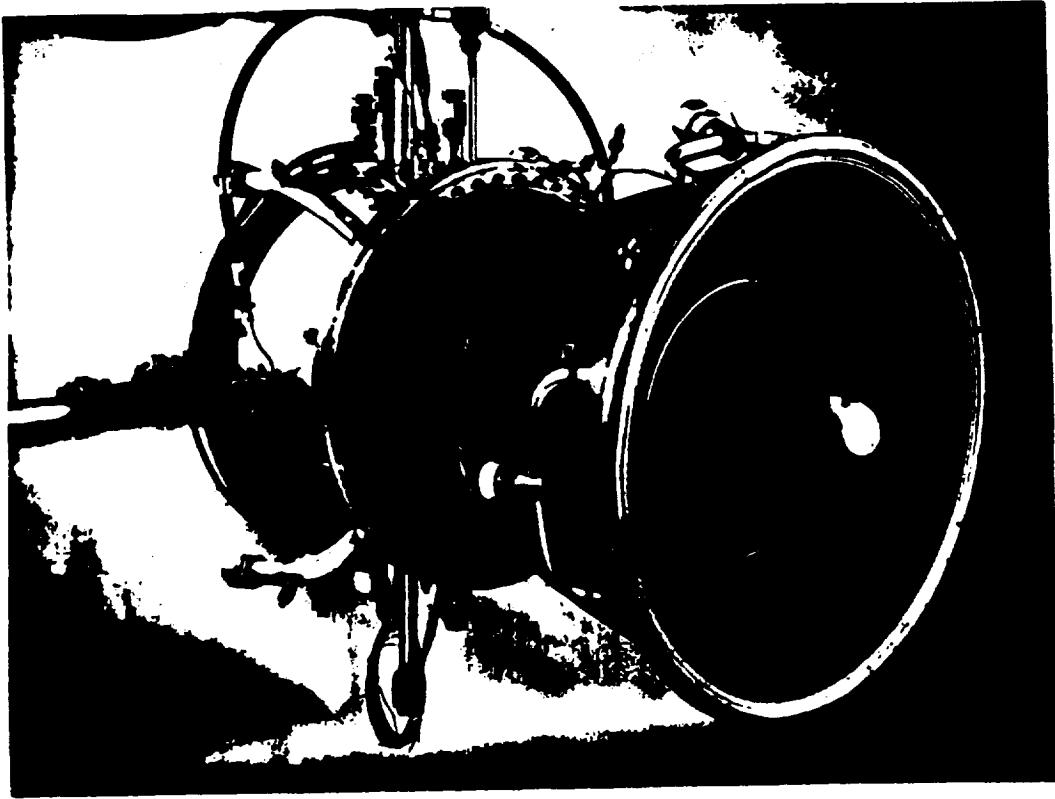

HYPERSONIC RAMJET DEVELOPMENT ENGINE
2 JUL 68

N 9 2 - 2 1 5 3 2

SCRAMJET ANALYSIS, TESTING

1992012290

J. L. Leingang
(F. D. Stull)

628266
10p.

Wright Research and Development Center
Wright Patterson AFB, OH

A survey of supersonic combustion ramjet (scramjet) engine development in the United States covers development of this unique engine cycle from its inception in the early 1960's through the various programs currently being pursued and, in some instances, describing the future direction of the programs. These include developmental efforts supported by the U.S. Navy, National Aeronautics and Space Administration, and U. S. Air Force. Results of inlet, combustor, and nozzle component tests, free-jet engine tests, analytical techniques developed to analyze and predict component and engine performance, and flight-weight hardware development are presented. These results show that efficient scramjet propulsion is attainable in a variety of flight configurations with a variety of fuels. Since the scramjet is the most efficient engine cycle for hypersonic flight within the atmosphere, it should be given serious consideration in future propulsion schemes.

U. S. AIR FORCE SCRAMJET DEVELOPMENT

Air Force interest in hypersonic propulsion began in the late 1960's under exploratory development programs conducted at Marquardt. Interest in a supersonic combustion engine was intensified when a single stage earth-to-orbit vehicle (Aerospace Plane) was conceived. Two airbreathing propulsion schemes were of primary interest: namely, the air collection system requiring a subsonic ramjet to power the vehicle during the air collection and oxygen storage phase of the flight, and the supersonic combustion ramjet engine. Hydrogen fuel was selected for this application because of its intrinsic cooling capability and its high specific impulse. Both propulsion approaches were pursued by vigorous component development programs and ultimately led to the development of a subsonic combustion thrust chamber capable of hypersonic flight, and several scramjet engines. During the past decade the USAF has sponsored a number of scramjet engine programs. The following engines are representative of the different types of scramjet engines developed and ground tested in these programs:

- (a) United Aircraft Research Laboratory Variable Geometry Scramjet
- (b) General Electric Component Integration Model (CIM) Scramjet
- (c) General Applied Science Laboratory Low Speed Fixed Geometry Scramjet
- (d) Marquardt Dual Mode Scramjet

These engines were hydrogen fueled and achieved performance levels which, in general, substantiated theoretical predictions. Experience was gained regarding potential problem areas such as unfavorable combustor-inlet interactions leading to inlet unstart, and reduced combustion

efficiency in divergent combustors. Although most of these engines were aerodynamically designed to operate over a wide range of hypersonic speeds and were substantiated by component tests conducted over a wide Mach number range, ground testing of the entire engine was restricted to a narrow Mach number range because of facility limitations. Hence, the full potential of these engines was never documented. A brief description of the first three engines will be given, followed by a more detailed discussion of the Marquardt Dual Mode Scramjet, which has undergone a relatively extensive testing program and is representative of an attractive concept for high speed aircraft.

UARL VARIABLE GEOMETRY SCRAMJET

A 45.72-cm-dia. water-cooled variable geometry scramjet engine was developed and tested at $M_0 = 5$ by United Aircraft Research Laboratory in the 1965-1968 time period. It was designed to operate over a wide Mach number speed range (up to Mach 12) with all supersonic combustion. The engine is axis symmetric incorporating a translating cowl which slides on three support fins. The translation of the cowl provides a variable inlet capture area and contraction ratio in order to obtain higher compression at the high Mach numbers, and more air flow at the low Mach numbers. At the same time, the cowl translation increases the combustor area ratio at the low flight Mach numbers to alleviate the problem of thermal choking, and also changes the nozzle area ratio in such a manner as to reduce the over and under expansion issues. The engine has four fuel injection stations, three on the center body and one on the cowl, and a gas generator ignition system. Over twenty free-jet tests were performed at the Ordnance Aerophysics Laboratory (OAL) in which inlet performance, pilot ignition, and engine performance under various injector configurations were investigated.

GE COMPONENT INTEGRATION MODEL SCRAMJET

Two 22.86-inch-diameter water-cooled variable geometry scramjet engines were designed and tested at $M_0 = 7$ by the General Electric Company in the 1966-1969 time period. The first engine, CIM-I, provided an evaluation of a combined set of scramjet components designed for operation up to Mach 8. CIM-I, constructed of chrome copper, had an axisymmetric mixed compression inlet with a movable centerbody, an annular combustor and a fixed annular plug nozzle. Two independent stages of normal injection were employed downstream of a small rearward-facing step to prevent propagation of combustion pressure rise from inducing separation in the inlet throat region. The combustor consisted of a constant area section followed by an 8 divergent section. Upon completion of testing in the General Electric Hypersonic Arc Tunnel, CIM-I was subsequently modified by replacing the cowl section with one having a smaller cowl lip angle to reduce external drag, and contouring some of the internal lines to increase performance. Extensive performance tests were conducted on CIM-II, to obtain the effects of varying inlet contraction ratio (13 to 25), equivalence ratio, fuel injector location, free stream Reynolds number and total enthalpy.

GASL LOW SPEED FIXED GEOMETRY SCRAMJET

A Mach 3-12 engine concept, involving a series of heat sink engine models of approximately 194 to 226 cm² of capture area, was developed and tested by the General Applied Science

Laboratories under the late Dr. Ferri in the 1964-1968 time period. This concept employs a fixed geometry closely integrated inlet-combustor design with low overall geometric contraction (<4), utilizing three-dimensional and combustor induced compression effects (sometimes referred to as thermal compression) to obtain an aerodynamic contraction ratio which varies with flight Mach number. At low Mach numbers, where flow disturbances propagate at large angles laterally, the swept back three-dimensional design permits large mass flow capture while preventing choking because of the large geometric flow area available. At high Mach numbers, where shock waves are highly swept, the stream tubes entering the inlet do not experience much lateral relief and thus are highly compressed in the local of large contraction. The resulting nonuniform combustor entrance flow is then diffused to relatively uniform conditions by utilizing combustion induced compression obtained from the proper placement of fuel injectors. Engine models demonstrating this concept have been tested at Mach = 2.7, 4 and 7 with inlet component tests covering Mach numbers from 2.7 to 11.3. Modifications to these designs were incorporated into a later engine model and tested at $M = 7.4$ in the GASL combustion heated high enthalpy blowdown tunnel under a wide variety of fuel injector patterns and fuel flow schedules.

DUAL MODE SCRAMJET

An attractive approach for the supersonic/hypersonic speed regime is the dual mode engine which combines the advantages of subsonic combustion at the lower flight speeds with supersonic combustion in the hypersonic regime. The main feature of this concept is that in principle the combustor operates in two modes: one for supersonic combustion and the other for subsonic operation. This can be accomplished by providing fuel injection at different axial locations within a common duct. the supersonic combustion section proceeds the subsonic one and acts as the subsonic diffuser of the inlet during the subsonic mode. An extensive component and engine development program was conducted by Marquardt in the 1964-1968 time period to develop this approach.

INLET DEVELOPMENT

Phase I analytical and experimental evaluations of a fixed geometry inlet which could satisfy both the low speed and high speed requirements of the Dual Mode Scramjet were conducted in mid 1965. This inlet, featuring highly swept leading edges was tested at AEDC at Mach numbers from 2 to 6. A larger scale inlet was also tested in a freejet cell at OAL at Mach 3 and 5 in combination with a combustor. Test results indicated that this type of inlet had the overall desired characteristics, but that nonuniform compression was occurring in the throat region which resulted in a low critical pressure recovery for the subsonic mode of operation.

COMBUSTOR/NOZZLE DEVELOPMENT

Phase I inlet/combustor tests conducted in the free-jet cell at OAL indicated the need for additional experimental tests to provide a reliable ignition source and possible piloting system for low Mach number operation. As a result, a series of full scale, direct-connect combustor tests was conducted at Mach 3 and 5 simulated freestream conditions at the Marquardt Research Field Laboratory. Igniters evaluated included H_2 -air, pentaborane, and fluorine.

Fluorine was shown to offer a positive and reliable ignition source under all test conditions. It was determined that piloting devices were not required in the low flight speed regime for the hydrogen fueled Dual Mode combustor. In addition to establishing ignition and piloting requirements, these tests investigated internal combustor contours and fuel injection patterns for maximum combustor performance in the subsonic and supersonic combustion modes. The ability to position the normal shock system by fuel modulation, while maintaining stable combustor performance during transition, was also demonstrated.

FREE-JET ENGINE TESTS

Based upon the results of the preceding Phase II inlet and combustor/nozzle tests, a water-cooled Dual Mode Scramjet Engine was fabricated and tested in 1967. The engine is a fixed geometry, two-dimensional configuration incorporating highly swept back features and designed to operate over a wide Mach number speed range by using subsonic and supersonic modes of combustion. Its basic nominal dimensions consist of height = 24.89 cm, width = 38.61 cm and overall length = 222.25 cm. With an inlet contraction ratio of 5.62, the capture area is 619.38 cm². Nozzle exit to cowl area ratio is 1.44. The fuel injection system, consisting of nine axial fuel injector locations along with two fluorine ignitors, allows for stable combustion mode transitions to be made with high overall engine efficiency. The engine model was fabricated from Inconel 718 and Hastelloy X and structurally designed for Mach 3-8 test conditions.

HYDROCARBON FUELED HYPERSONIC ENGINES

At the conclusion of the dual mode scramjet program and the other successful scramjet engine programs, USAF interest shifted from large scramjet vehicles to smaller missile systems leaving the hydrogen scramjet area to NASA with their HRE and other programs. As a result, attention focused on the hydrocarbons and fuels with a high density impulse. Ignition delay and reaction times for gaseous hydrocarbons are much longer than for hydrogen, hence the problem of achieving high combustion efficiencies using these fuels proved more difficult than for hydrogen. Initially, attempts were made to simply modify the existing hydrogen scramjet engines by lengthening the combustor section and using gaseous fuels such as methane and ethylene, but these met with only limited success. Extensive effort has been devoted to the development of piloting systems for use in scramjet engines employing liquid hydrocarbon fuels, and is the approach employed in the Dual Mode Hydrocarbon Scramjet. The concept of a pilot is to provide a high temperature gas source along with a large concentration of free radicals. Good supersonic combustion efficiencies have been obtained using liquid hydrocarbon fuels in tests where suitable fuel injector piloting systems have been developed.

PROPOSED USAF/NASA X-24C RESEARCH VEHICLE

In light of technical interest and engineering activity relative to a variety of propulsion concepts as well as other interests existing in technical domains of structures, subsystems and miscellaneous components including avionics, efforts have been made by a joint USAF/NASA ad hoc group to describe the performance and design requirements for a low cost research vehicle. In essence, the aim of this group has been to provide a "flying wind tunnel" that would be free of some of the encumbrances encountered in ground facilities, provide a capability for

demonstrating large scale propulsion and structures in the actual environment, provide data by which to correlate ground facility results, and provide an insight into synergistic effects on various systems.

PROPULSION OPTIONS

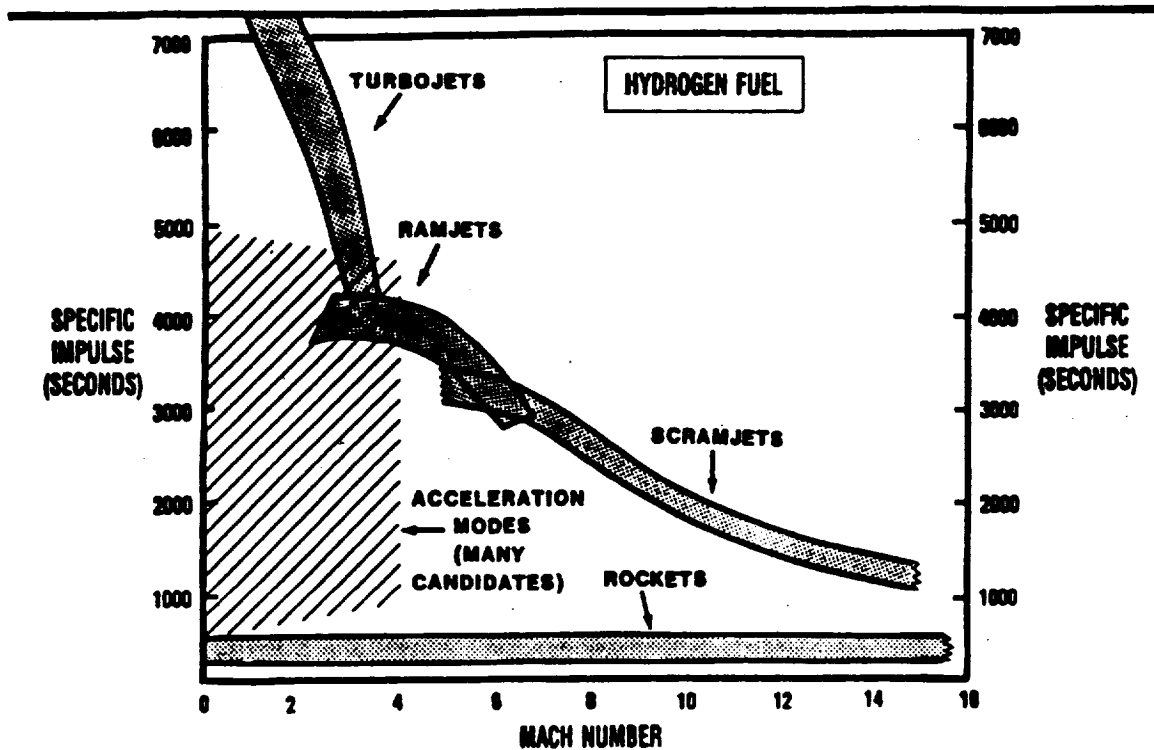

SCRAMJET ENGINE TESTS

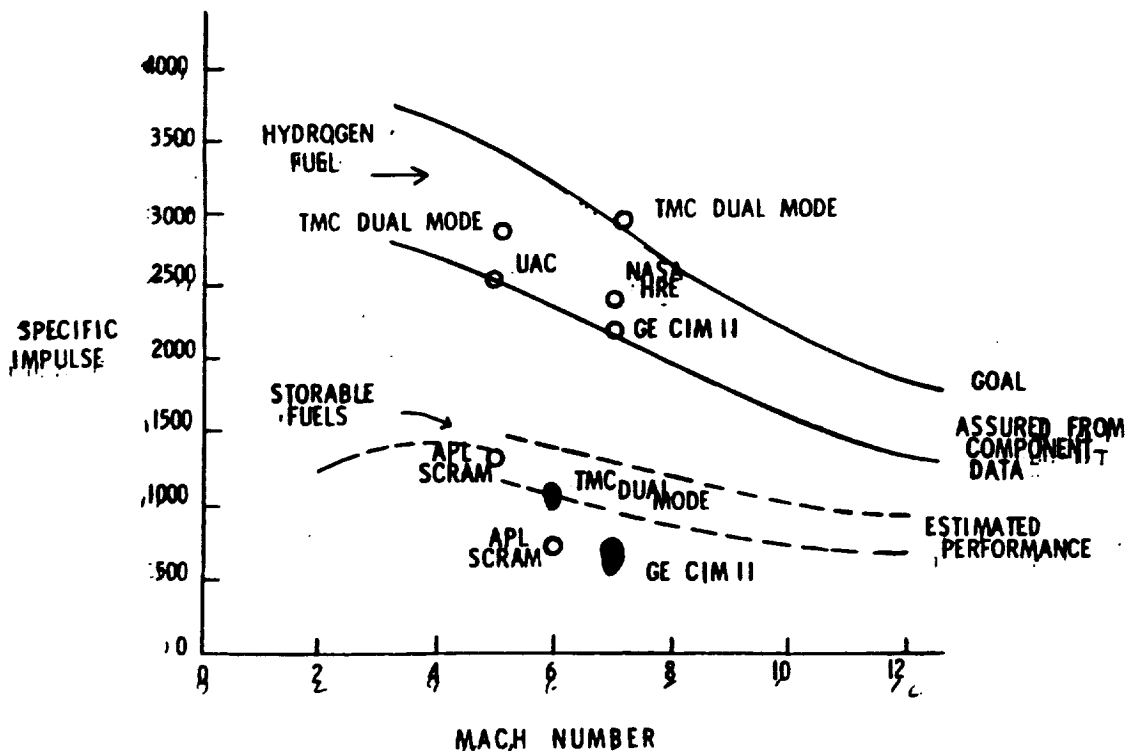

HRE PERFORMANCE GOALS

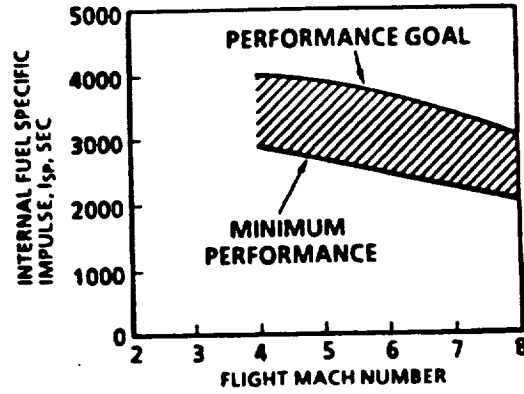
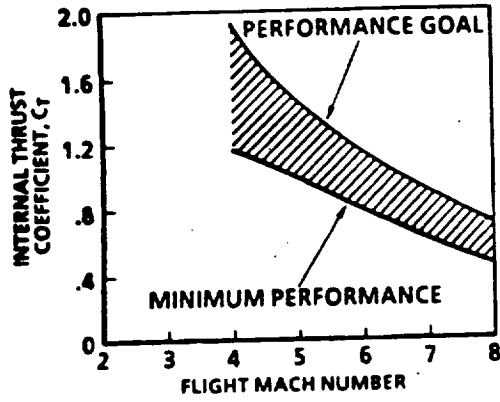

MACH 6 COMBUSTOR EFFICIENCY

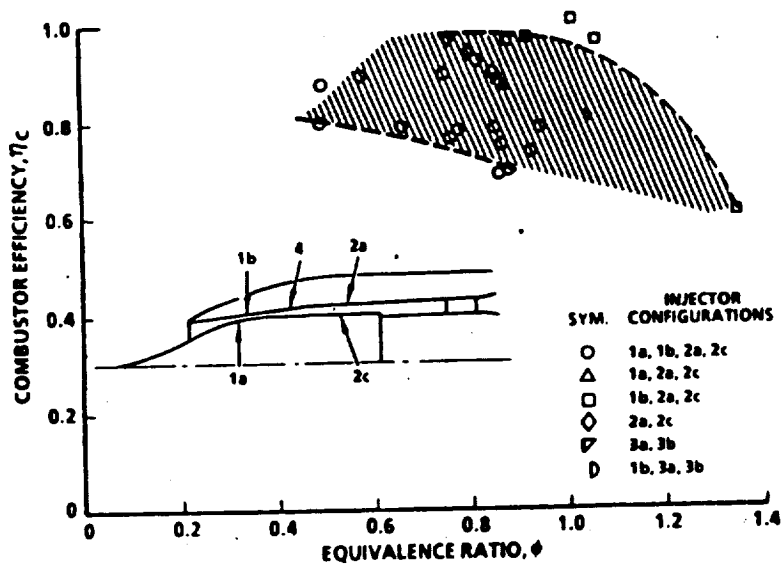

AIM INTERNAL PERFORMANCE COMPARISON

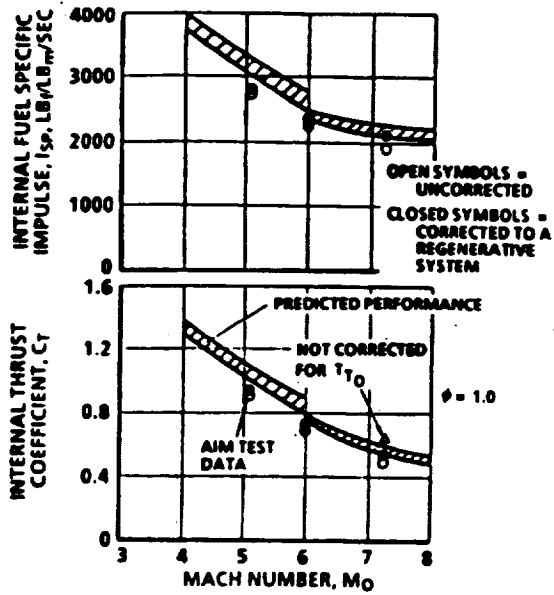

MACH 5.1 INTERNAL PERFORMANCE SUBSONIC COMBUSTION

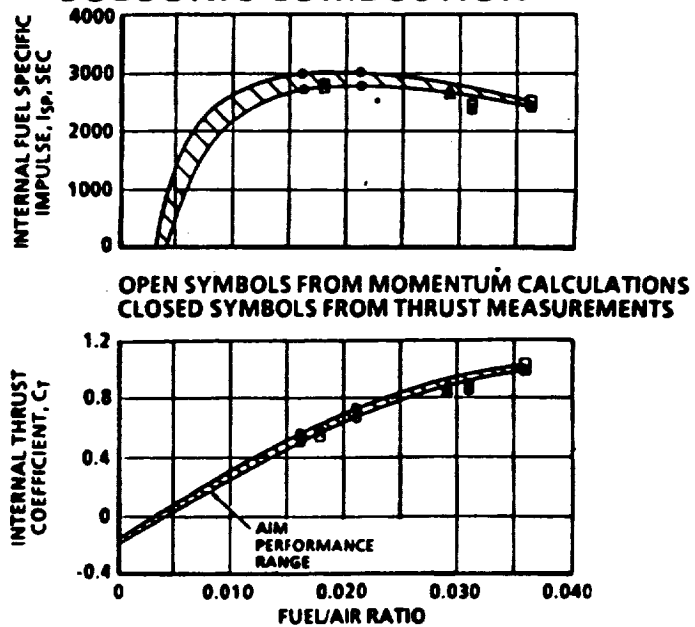

Nozzle Characteristics for RBCC Hypersonic Systems

**S. Halloran
Rocketdyne Division**

(Paper Not Received in Time for Printing)

199201229

N 9 2 - 2 1 5 3 3

628267
8p.

**SYSTEM CONTROLS CHALLENGES
OF HYPERSONIC COMBINED-CYCLE ENGINE
POWERED VEHICLES**

**Russell H. Morrison
and
George D. Ianculescu**

**Rocketdyne Division
Rockwell International Corp.
Canoga Park, CA 91303**

INTRODUCTION

Hypersonic aircraft with air-breathing engines have been described as the most complex and challenging air/space vehicle designs ever attempted. This is particularly true for aircraft designed to accelerate to orbital velocities. The aerodynamic extremes of hypersonic flight will users in new parameters and requirements for effective vehicle control. The propulsion system for the National Aero-Space Plan will be an active factor in maintaining the aircraft on course.

Typically addressed are the difficulties with the aerodynamic vehicle design and development, materials limitations and propulsion performance. The propulsion control system requires equal concern. Far more important than merely a subset of propulsion performance, the propulsion control system resides at the crossroads of trajectory optimization, engine static performance and vehicle-engine configuration optimization. To date, solutions at these crossroads are multidisciplinary and generally lag behind the broader performance issues. Just how daunting these demands will be is suggested in this brief, somewhat simplified treatment of the behavioral characteristics of hypersonic aircraft and the issues associated with their air-breathing propulsion control system design.

CONSIDERING HYPERSONIC AIRBREATHING PROPULSION

The technology that is central to single-stage-to-orbit (SSTO) hypersonic aircraft is the ramjet-scramjet engine that propels the vehicle from roughly Mach 3 to orbital speeds. Characteristically, the vehicle is long, with a large fuselage volume for the fuel, and a relatively small wing area. Conventionally, the engines are mounted horizontally beneath the fuselage, where the high velocity and attitude of the vehicle, along with the shape of its forebody, compress air entering the engine inlets. Thus, the entire forebody is fundamentally part of the engine inlet. Equally important, the vehicle aftbody serves as a part of the engine nozzle.

Combustion performance in the engine is directly tied to the efficiency with which the forebody-engine inlet combination captures air. Forebody shocks and early boundary layer transition dissipate total energy, reducing efficiency. Buildup of thick laminar boundary/entropy layers along the forebody creates stratification of the entering air, reducing the total air capture and

thus affecting combustion performance.

Figure 1 illustrates aspects of ramjet and scramjet mode operation. In the upper illustration, the "start" and "unstart" conditions are depicted in the start condition, supersonic flow and the "normal shock" - where it slows to subsonic velocities - is established well into the engine; unstart describes a condition in which the normal shock moves forward and "stands" in front of the inlet. When this occurs, airflow into the engine is greatly reduced, high forces downstream of the shock cause severe pitching movements of the aircraft, and air spillage interferes with the other inlets. In the lower two illustrations, airflow in a ramjet configuration is compared with that in a scramjet. Ram mode of operation commonly begins at Mach 2 to Mach 3, while the transition to "scram" operation begins at about Mach 5 to Mach 7.

The inlet is considered "started" when supersonic flow is established all the way into it. "Unstart" refers to a condition in which a shock "structure" associated with a breakdown to subsonic flow moves out of the inlet and stands in front of the engine. When this occurs, airflow into the engine is substantially reduced, forebody pitching moments are greatly increased, and spilled air may interfere with adjacent inlets, giving rise to the so-called "zipper effect" in which all inlets are unstarted. The two principal factors affecting unstart are inlet disturbances (atmospheric changes, gusts, boundary layer separation, etc.) and back pressure from the combustor or engine geometry. Thus, mastery of disturbance effects and combustor back pressure can be especially important in controlling engine start/unstart conditions.

The ramjet engine differs from the scramjet engine in that the inlet air is decelerated to subsonic velocities inside the engine flow path before it is mixed with the fuel for combustion. This deceleration, of course, requires a normal shock or dynamic inside the engine with attendant high stagnation temperatures and pressures ahead of the engine combustion zone. The ram mode of operation commonly begins around Mach 2 to Mach 3. At about Mach 5 to Mach 7 the engines begin a transition to the scram mode of operation. In this mode, air remains at hypersonic velocities all the way through the engine (there is no normal shock), thus, its name, "scramjet," for *supersonic combustion ramjet*. Scramjet operation can continue up to altitudes in excess of 200,000 feet and at Mach numbers in excess of 16. The National Aero-Space Plane (NASP) design concepts all use hydrogen as the fuel, primarily because it is the only fuel which can burn fast enough to go to complete combustion inside the engine at very high air velocities.

Combustion efficiency is most dependent upon how well and how quickly the fuel mixes with the air as the combustion reaction goes to completion. Stratification of the air entering the combustor results in a vertical imbalance of air mass distribution in the combustor. Unless compensated for, this imbalance can result in an incomplete combustion of fuel in boundary layer regions. Matching fuel flow to inlet airflow is important to overall system efficiency in achieving the orbital mission objective. Fuel that goes unburned, either because of low air capture by the forebody/inlet or as a result of poor mixing in the combustor, does contribute to thrust -- but far less effectively.

Conservation of energy and momentum principles define the gross thrust produced by the engine, but the effectiveness with which the combustion products are expanded in the engine

nozzle and against the aftbody of the aircraft is important for maximizing the conversion to net thrust and minimizing vehicle drag. Inlet flow fluctuations, when uncompensated by engine design or engine control actions, will be reflected and/or amplified in the exhaust flows. Because the forebodies and aftbodies constitute an asymmetrical inlet-engine-nozzle combinations, they jointly affect the vehicle lift and moment balances, as well as the usual thrust-drag balance. The decoupling or compensating of outflow from inlet fluctuations is a major function of the engine controls.

High ram and scram operation produces high total temperature air that, even in the inlet before combustion, may greatly exceed the safe operating limits of the flow path materials. In fact, the hydrogen required to satisfy the cooling requirements of the engine and airframe actually exceeds that needed for thrust over much of the flight envelope. The thermal management problem is further exacerbated by the fact that the relative heat flux experienced by the various portions of the aircraft and engine can change significantly and non-uniformly due to the higher air velocities and shifting shock-zone locations over the SSTO trajectory. Static design practice requires that each coolant circuit be designed to provide flow to accommodate the peak heat flux at that location. Unfortunately, at all other points of the flight envelope that location would then be overcooled. In regions of the SSTO trajectory where the total coolant demand by the vehicle exceeds thrust demands, excess fuel from overcooling of low heat flux regions in the engine is burned, further lowering engine performance. For this reason, certain features may be included in the engine/vehicle design to actively balance (control) the flow of coolant to various parts of the vehicle during flight in order to maintain thermal margins and minimize the use of excess hydrogen for cooling.

Aircraft and engine inlet aerodynamicists and the combustor designers, therefore, must engage in refined and systematic trade studies to optimize the integrated configuration with a "best" trajectory which will satisfy the mission requirements. However, a perplexing situation has developed with the selected X-30 SSTO configuration. The same air providing the bulk of the aerodynamic lift and drag to the vehicle is also consumed by the engines in order to produce thrust, causing a degree of interaction heretofore unprecedented. An added complication is the three-dimensional nature of the flow under the forebody of the example aircraft. Figure 2 compares this overall airflow situation for a typical subsonic aircraft and a lifting-body type hypersonic vehicle. Considered here, the local angle of attack and sideslip of the air at the entrance of the center engines is *not* the same as that at the inlet to the outer engines.

ENGINE/VEHICLE INTERACTIONS

For example, consider the engine-vehicle interactions from the aircraft flight control designer's point of view. With an underbody configuration, the engine provides a significant lift component from both the inlet and exhaust streams, which can be modified by changes in throttle setting and Mach number. The vehicle trim is consequently affected and the several stability derivatives (e.g., pitch moment) are changed as well. With a nozzle that comprises external expansion along the aftbody, there is an effective thrust vector angle. This angle must be trimmed out by the aircraft controls, since it will add an increment in pitch moment with speed change.

Now, consider these same interactions from the point of view of the engine controls designer.

The engine inlet will be continuously subjected to perturbations at nominal performance. These perturbations occur in free-stream air density (pockets of 50 percent variations possible at higher altitudes) and in angles of attack and sideslip resulting from aircraft maneuvers over its flight trajectory. Involved are flight control system adjustments for shifting center of gravity, fuel slosh and even aircraft bending modes. With air-residence time in the engine on the order of 1 to 10 milliseconds and combustion rates measured in 10th of a millisecond, bending modes up to several hertz may be considered low frequency to the engine. These perturbations affect the quantity of air captured by the engine inlet.

Additionally, as shown in Figure 3, these effects will in all likelihood be non-uniform across the array of engines, further lowering engine performance. For this reason, certain features may be included in the engine-vehicle design to actively balance (control) the flow of coolant to various parts of the vehicle during flight in order to maintain thermal margins and minimize the use of excess hydrogen for cooling. For example, consider that the engine/vehicle inlet flow fluctuations will perturb the internal flows and shock structures of each engine uniquely. Unchecked, these effects may cause incomplete combustion, fluctuations in thrust and exhaust flows, unstarted inlets and thermal imbalances. These effects will also carry through to the aftbody drag and lift vectors, potentially adding to the lift-moment and thrust-drag imbalances. Depending on the vehicle configuration and the specific nature of these interactions, the open loop engine response may amplify or attenuate the perturbations seen by the aircraft. As an example, consider an aircraft perturbation yaw angle to the right, as reflected in Figure 3. Airflow to the left engines is relatively undisturbed, but that to the right engines is greatly disturbed by forebody crossflow. The left engines capture more air, increasing thrust, while the right engines sustain reduced thrust - thus amplifying the condition causing the yawing effect in the first place.

Figure 4 presents the general aerodynamics and propulsive flow conditions affecting the pitch-plane attitude control and thrust/drag forces. In combination, the forebody and aftbody constitute an asymmetrical inlet-engine-nozzle combination. Thus, they jointly affect vehicle lift and moment balances, as well as the usual thrust-drag balance.

Clearly then, guidance and control of an SSTO vehicle is an encounter of significant complexity. Engine controls will include the valves and effectors manipulating the flows and geometry of the engine, the controlling logic embodied in the real-time software, the implementing controllers/computers, and the suite of instruments feeding back control parameters from the engine. These controls must be compatible with and interact with the vehicle management system to configure the engines for delivery of the commanded thrust while imparting the desired lifts and moments to the aircraft - including correction of imbalances across the engine array. The controls must also maximize engine performance by controlling and maintaining proper engine fuel-air-equivalence ratios. And finally, they must ensure engine and vehicle safety by controlling coolant flows, providing smooth mode transitions, minimizing unstart/restart transients, effectively monitoring engine condition and stating parameters for signs of degradation, and decoupling/desensitizing outlet flows from inlet fluctuations.

Development of candidate control system concepts must, therefore, include definition of the control features to be incorporated in the physical engine, along with analysis of performance

requirements for all elements of the control system, coordinated total aircraft-engine controls integration and logical interface structure definition. Driving the development planning will be the key issues of vehicle weight, various performance phenomenology, vehicle integration and, finally, control performance assessment.

The aircraft-engine description presented here implies an engine concept with a large number of control effectors and control measurements. The speed of the physical processes drives up the computational speed requirements. In parallel, system requirements for safety, reliability and supportability drive the redundancy requirements and the complexity of the engine monitoring system. Accordingly, the various measures of control system complexity and difficulty (throughput, memory, source lines of code, environment, etc.) in the hypersonic air-breathing engines generally range from 2 to 10 times that for the Space Shuttle Main Engine, as an example. As a result, substantial effort is mandated to define the minimum necessary control requirements and to bring the most advanced, ultra-lightweight control system technologies to bear on the implementation concept. Included is everything from lightweight composite materials in structural applications to very high-speed integrated circuits (VHSIC) and very large-scale integrated circuit (VLSIC) technologies in electronics.

STATIC CONTROL ACCURACY

One aspect of this is the effect of static control accuracy. Ignoring the dynamics of perturbations response, this factor affects how accurately key engine performance parameters can be measured in relation to a given mission. The SSTO mission has two such parameters. The first is specific impulse, I_{sp} - the thrust divided by fuel flow rate. Higher I_{sp} means lower fuel flow rate for a given thrust, or less fuel consumed or a smaller vehicle. The second parameter is closely related: engine fuel to air-equivalence ratio, stated as θ . This is the ratio of actual fuel flow rate to that required for *stoichiometric combustion* -- where both oxygen and hydrogen are completely consumed in the combustor. This maximum of engine performance is expressed as $\theta = 1$. Thus, when coolant demands exceed thrust demands on fuel flow, θ is greater than 1 and I_{sp} is reduced as some fuel leaves unburned. At $\theta < 1$, some are unburned, combustor temperatures are generally lower and I_{sp} is reduced.

Fuel flow is simple to measure with a reasonably high degree of accuracy. To get I_{sp} , thrust is measured. To get θ , airflow rate is measured through the flow path. Systems to measure these parameters generally involve a collection of intrusive and/or non-intrusive sensor, signal and data processing circuitry and calculation algorithms, anchored by test data or CFD. The hostile environment of the flow path limits the available sensor technology, and the lack of test data over the flight envelope adds uncertainty to the calculation algorithms. Nevertheless, given the elements of the measurement systems, one can statistically determine the uncertainty that can be expected in measured engine performance over the SSTO trajectory.

If the control system is trying to hold an θ of 1 and the θ measurement says that the engine is operating at an θ of 1, *but the real θ is 1.1*, then the vehicle designer either must have compensated for the resulting reduction in I_{sp} with additional fuel or accepted the risk of not achieving orbit. Control feasibility, therefore, depends on a favorable uncertainty analysis, and performance accounting will eventually require consideration of these uncertainties.

CONCLUSIONS

The challenge, then, is formidable. A ramjet-scamjet engine and hypersonic vehicle combination will be a total systems integration, characterized by sensitive and strong interactions between nearly every key variable - from the forebody motions associated with aircraft bending to engine exhaust flows on the aftbody of the aircraft. Multiple disciplines from aerothermodynamics to heat transfer to electronic software design will be employed to derive a control system concept that is capable of delivering commanded thrust while optimizing engine performance and ensuring engine-vehicle safety.

ACKNOWLEDGEMENT

This presentation was excerpted with permission from the article, "Keeping Hypersonic Flight Under Control" by the same authors. It appears in the Summer 1991 issue of Threshold, Rocketdyne's in-house publication.

Start Condition

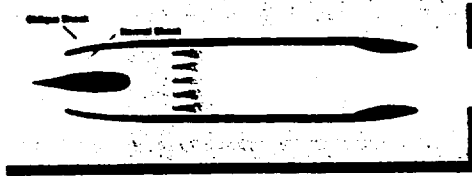

Unstart Condition



Typical Ramjet $V_1 > V_2 < \text{Mach } 1$

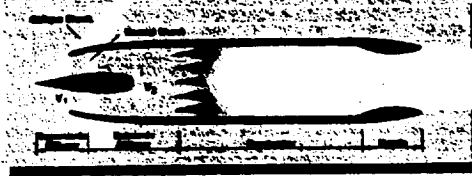

Typical Scramjet $V_1 > V_2 > \text{Mach } 1$

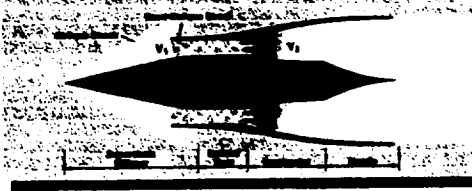

FIGURE 1 - AIRFLOW CONDITIONS FOR ENGINE RAMJET AND SCRAMJET OPERATING MODES.

**Airflow Thrust and Lift Blend to Unprecedented Levels
Propulsion-Aerodynamics Interactions Are More Challenging To Control**

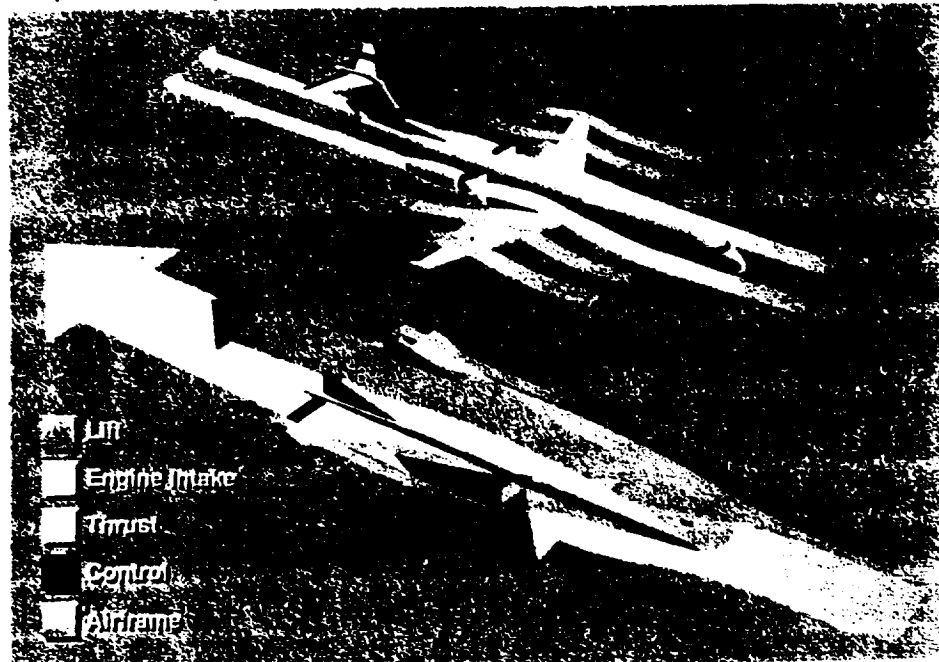

FIGURE 2 - AIRFLOW COMPARISON FOR TWO VEHICLES.

Perturbed Flow Condition

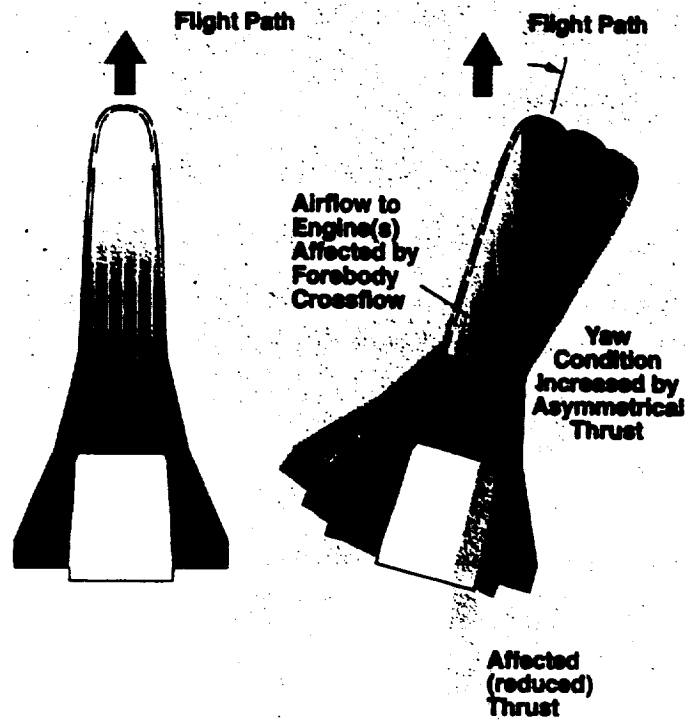

FIGURE 3. - VEHICLE ATTITUDE AND ENGINE OPERATION INTERACTIONS.

Engine-Vehicle Interactions

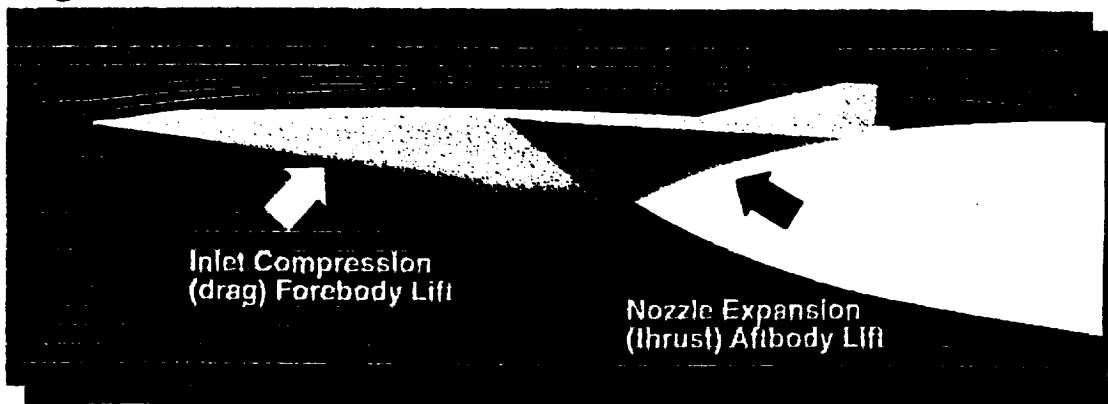

FIGURE 4. - ENGINE-VEHICLE INTERACTIONS.

NASP X-30 PROPULSION TECHNOLOGY STATUS

William E. Powell
 Deputy Director Systems Application
 NASP JPO (NASA)
 WPAFB Dayton, Ohio

1992012292
 628268
 10p.

Successful development of the NASP demands a propulsion system which operates efficiently across the entire NASP operational flight envelope and at speeds ranging from the takeoff to near-orbital velocity. To meet this challenge, research is being conducted to develop specific air-breathing engine designs which exhibit high effective specific impulse using combined subsonic-supersonic-combustion ramjet/scramjet propulsion concepts. Scramjet engine performance critically depends upon effective, synergistic integration of new propulsion technologies with the basic NASP airframe (see Figure 8-1).

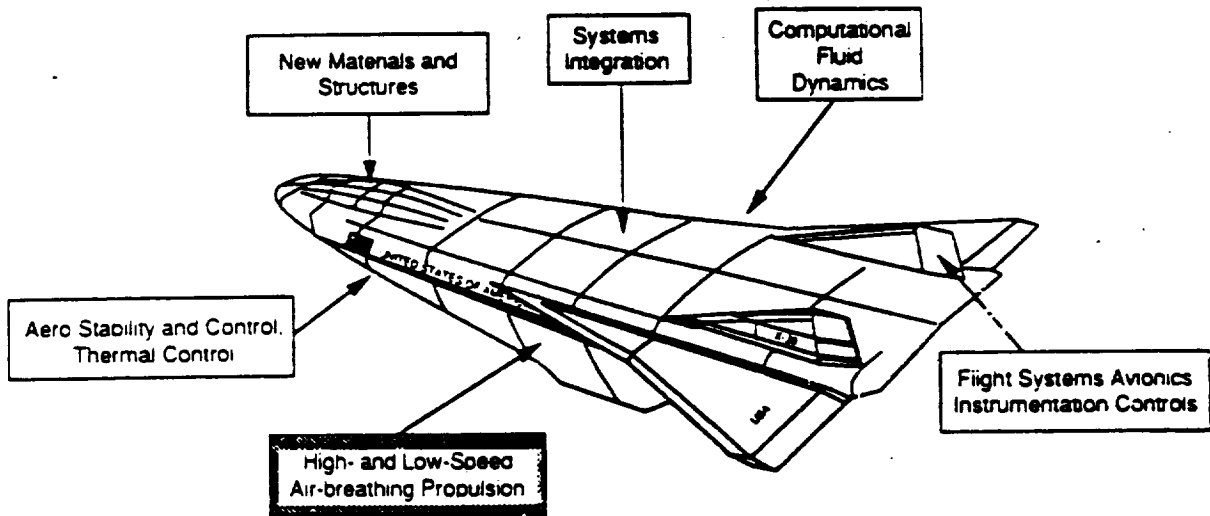

Figure 8-1. The Propulsion Challenge

The performance goals of the NASP program require an aero-propulsion system with a high effective specific impulse. In order to achieve these goals, the high potential performance of air-breathing engines must be achieved over a very wide Mach number operating range. This, in turn, demands high component performance and involves many important technical issues which must be resolved.

Scramjet Propulsion Technology is divided into five major areas: (1) inlets, (2) combustors, (3) nozzles, (4) component integration, and (5) test facilities. Critical areas of focus for the component areas (inlets, combustors, and nozzles) are the resolution of key technical issues, development of a high Mach number design methodology, and establishment of a high Mach number performance data base that will meet the challenging goals of the high performance and minimum weight engine required for NASP. In component integration, integrated models of selected component designs must be tested in order to resolve component integration problems and to evaluate overall engine performance. Test facilities are required (1) to provide Mach 5-8 test capabilities of sufficient scale in order to conduct and support the engine contractors' propulsion module tests and (2) to provide very high Mach number simulations for smaller scale component tests.

The scramjet inlet technology area addresses the key issues of inlet contraction ratio, inlet efficiency and air capture, boundary-layer effects and simulation, shock/boundary-layer interactions, and real-gas effects. The waves in the internal portion of a hypersonic inlet tend to coalesce into a strong shock giving rise to a large adverse pressure gradient. Increasing the contraction ratio aggravates the problem, thereby finally limiting the allowable compression ratio before massive separation occurs. Relatively long forebodies are required to minimize shock losses at high Mach numbers. Consequently, the boundary layer tends to become relatively thick. The airframe shape and type of profile can have a significant impact on inlet performance and its operating characteristics. Also, at very high Mach numbers, the effect of O_2 vibration can become important. Wave structure of any given geometry is unique, and important inlet characteristics, such as air capture, are difficult to match unless properly simulated. Combined analytical and experimental efforts will provide answers to these issues, as well as develop the methodology to design, test, analyze, and evaluate high performance hypersonic inlets. Tests of small aerodynamic models will be conducted over a wide Mach number range, including both wind tunnels and shock tunnels, and will be complemented with applied computational fluid dynamics.

Hypersonic vehicles tend to utilize their long forebodies as part of the inlet compression process. This results in forebody boundary layers being ingested into the propulsion system. In most cases, the complete forebody-inlet system is difficult to model in a propulsion system test. Therefore, a technique to generate thick boundary layers in supersonic flow must be developed with the proper momentum defect distribution.

Studies in the scramjet mixing area address the key issues of penetration, wall and strut injection, supersonic shear layer mixing, and mixing augmentation techniques. Experimental programs are underway to investigate shear layer mixing and hypermixing concepts and to compare these results with CFD codes using modified turbulence models. Several mixing augmentation techniques, including longitudinal vorticity production and shock interactions, will be investigated through university grants using the NASA Langley Mach 6 high Reynolds number tunnel.

Shear flow development and mixing characteristics of noncircular nozzles were investigated and compared to a circular jet over a range of Mach numbers at the Naval Weapons Center (NWC), China Lake, California. Hot wire measurements and schlieren photography were obtained. The superior mixing characteristics of elliptic and rectangular jets relative to the circular jet, which were known to exist for subsonic jets, were also found in the transonic jet and were further augmented by the shock structures of the supersonic under-expanded jet.

Areas to be investigated in hypersonic mixing are effects of incoming boundary-layer turbulence, longitudinal vorticity production, surface distortion, and shock enhancement.

The scramjet combustor technology study area addresses the key issues of film cooling/skin friction, ignition enhancement/flameholding, combustor performance, diagnostics, and effects of initial conditions. At high flight Mach numbers, protection of the combustor wall is of paramount importance due to the extremely high enthalpies of the incoming flow. Likewise, momentum of the fuel is a major factor, and coaxial injection is required for most fuel to maximize thrust. Film cooling offers the possibility of simultaneously protecting the wall from excessive heat flux and reducing wall shear. However, coaxial injection is not conducive to rapid mixing. Measurements are not only more difficult to make, but they must be more extensive than in a subsonic combustor since in supersonic combustion there is no defined sonic point and exit property profiles are generally nonuniform. Therefore, the entire combustor exit flow field must be measured to accurately assess combustor performance and to provide initial conditions for nozzle flow analysis. Combined analytical and experimental efforts, supplemented by university grants, will clarify these key issues and provide sufficient understanding to design a supersonic combustor capable of operating over a wide Mach number range. New instrumentation techniques and laser diagnostics will provide detailed flow-field measurements with which to calibrate computational codes.

The scramjet kinetics study area addresses the issues of chemical kinetics, reaction rate constants, and enhancement techniques for the three-body recombination reaction. A chemical kinetic data base is being acquired for reliable computer simulation of hydrogen/air supersonic combustion and for tests performed in facilities using vitiated air. A shock tube and high temperature kinetics cell, along with computational chemistry methods, are being utilized to obtain the critical rate constants at required accuracy over a wide range of temperatures. Identification of chemical additives that can speed up the exothermic combining of radical species and experimental evaluation of their effectiveness will be accomplished.

A sensitivity analysis of the hydrogen and air chemical reaction model was performed by Los Alamos National Laboratory to identify which specific reactions are the key rate-limiting steps in the heat release mechanism under conditions relevant to scramjet propulsion.

The scramjet nozzle technology area addresses the key issues of nonequilibrium thermochemical effects, fluid dynamic losses, thrust vector control, and entrance profile effects. A major thrust loss mechanism in supersonic nozzles at high Mach numbers is the thermochemical energy retained by dissociated species when subjected to a rapid expansion process. Other mechanisms which lead to large losses include wall skin friction and heat transfer, divergence, and internal compression waves generated by nonuniform entrance conditions. Combined analytical and experimental efforts will provide answers to these issues and demonstrate internal nozzle performance, as well as develop a data base for flight Mach numbers over a wide range of Mach numbers using both steady state and pulse facilities.

The scramjet component integration technology area addresses the key issues of combustor/inlet interaction, forebody effects on performance, and combustor flow profile/nozzle performance. Flow profiles (including the nature of the boundary layer) coming from one component will affect the performance of subsequent components. For airframe-integrated scramjets, it is especially important to investigate the effects of a simulated forebody flow on the performance of the engine module. Combined analytical and experimental efforts will help answer these issues, as well as develop a broad scramjet data base over a wide Mach number range. Both vitiated and arc-heated freejet NASA Langley scramjet facilities and the Calspan 96-inch shock tunnel will be utilized in establishing early scramjet engine performance levels and resolve any key integration issues.

NASP IMPACT ON SSTO AEROSPIKE

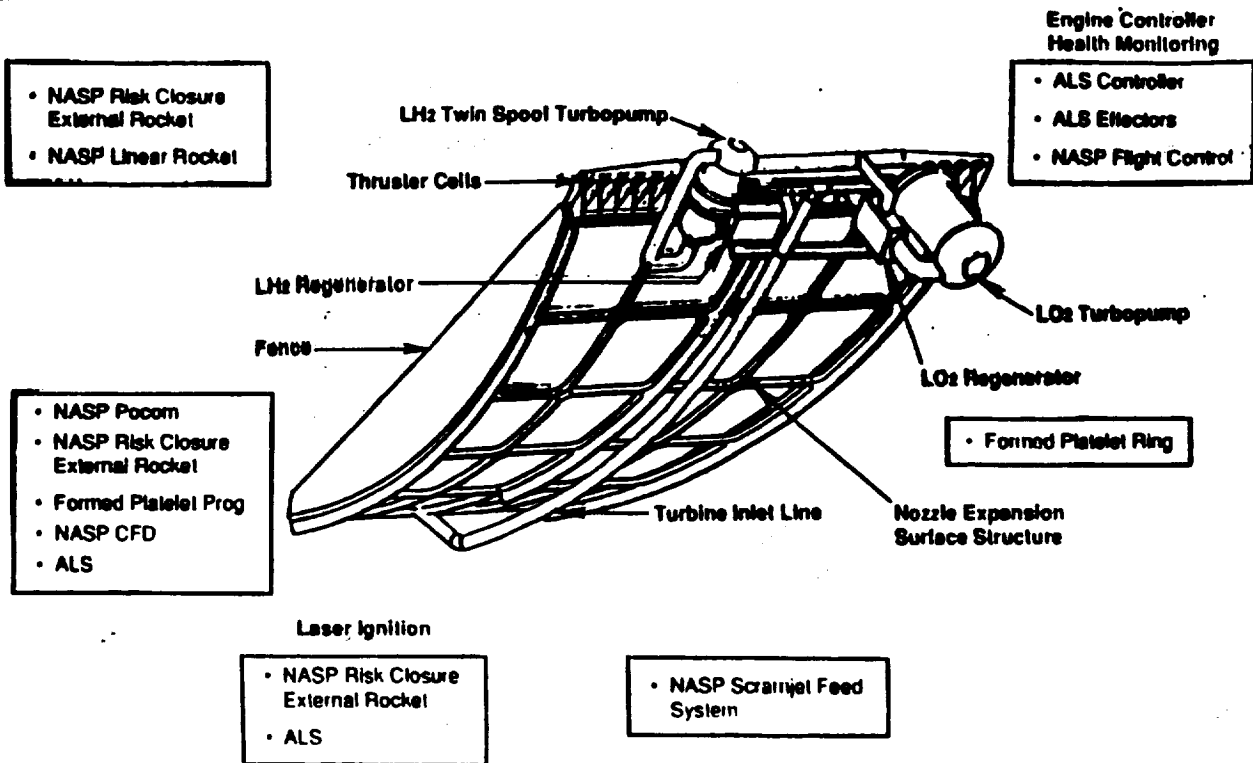

Objective:

- Design, Build, Test X-30 Engine Components to Demonstrate Technology
- CFD Codes to Predict Inlet Mass Capture, Combustion Efficiency

Pay-Offs:

- Revitalized National High-Speed Propulsion Test Facilities
- Extensive Scramjet Data Base
- High Conductivity Materials for Heat Exchangers
- Advanced 3D CFD Propulsion Codes with Accurate Physical Modeling for Mixing, Combustion

Summary

Execution : NASP JPO, Contractor, GWPs
 Funding : PE 63269F and NASA

Funding (\$M)*	398	96 8	114	114	200	225	253	272	308	338	338	272	253	3208	
Tasks	FY	Prior	91	92	93	94	95	96	97	98	99	00	01	02	Total
X-30 Engine															
Engine Structure/ Material			(1)	(2)		(3)			(4)						
APTU				(5)	(6)										
Flight Test Validation										(7)					

* Phase 3 Funding Estimate Provided by Air Staff
 * Actual Program Funding Requirement Due 2nd QTR FY92

Milestones:

1. Concept Selection (4/91)
2. Size Freeze (2/92)
3. Technology Freeze Date (1/94)
4. Engine Delivery (4/97)
5. Material Flight Engine #1 Selection (1/93)
6. Structure Component Tests (3/93)
7. APTU Ram/Scramjet Flowpath Test Facility - FY96

Propulsion Test Facilities

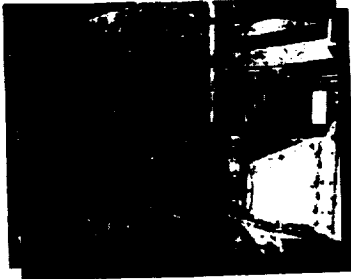

Objective:

- Provide Propulsion Technology and Development Test
 - Develop Combustor Concepts
 - Develop Integrated Engine Configurations

Pay-Offs:

- Enabling Technology for Wide Range of Revolutionary Mission Concepts
- Free World's Largest Hypersonic Engine Test Capability
- Complete Testing Capability for Airbreathing Engines up to Mach 8
- Full Range of Component Test Capability

Execution : NASP JPO, Contractor, GWPs
Funding : PE 63269F and NASA

Funding (\$M)*		74.3	10.1	21.4	21.3	37.5	42.2	47.5	51.0	63.3	63.3	63.3	51.0	47.5	60.1
Tasks	FY	Prior	91	92	93	94	95	96	97	98	99	00	01	02	Total
Engine Test Facility (ETF)															
Static Stand															
ASTF															
APTU															
Others						(6)									
Flight Test Validation															

- Phase 3 Funding Estimate Provided by Air Staff
- Actual Program Funding Requirement Due 2nd QTR FY92

Milestones:

1. Subscale High Mach Combustor Development Facilities- 4Q FY92
2. Static Test Stands - FY96
3. ASTF System Test Facility - FY96
4. APTU Ram/Scramjet Flowpath Test Facility - FY96
5. Component Test Facilities - FY94
6. Full Scale Shock Tunnel for Combustor Development
7. LaRC 8' HTT Upgrades FY93

Ramjet / Scramjet Engines



Objective:

- Develop and Demonstrate Hypersonic Airbreathing Propulsion Systems
 - Innovative Engine Structure Concepts
 - Large Scale Scramjet Data Base

Pay-Offs:

- High Specific Impulse Propulsion Systems
- High Temp. Composites for Heat Exchangers
- Validated Hypersonic Combustion Codes

Execution : NASP JPO, Contractor, GWPs
Funding : PE 63269F and NASA

Funding (\$M)*		280	70.0	63.5	63.2	146	165	165	198	247	247	247	199	165	2348
Tasks	FY	Prior	91	92	93	94	95	96	97	98	99	00	01	02	Total
X-30 Engine															
Engine Structure/Materials			(1)	(2)		(3)			(4)						
Flight Test Validation					5/6										

- Phase 3 Funding Estimate Provided by Air Staff
- Actual Program Funding Requirement Due 2nd QTR FY92

Milestones:

1. Concept Selection (4/91)
2. Size Freeze (2/92)
3. Technology Freeze Date (1/94)
4. Engine Delivery (4/97)
5. Material Flight Engine #1 Selection (1/93)
6. Structure Component Test (3/93)

Advanced Auxiliary Propulsion



Execution : NASP JPO, Contractor, GWP's
 Funding : PE 63269F and NASA

Funding (\$M)*		81.9	7.8	9.2	9.2	16.1	16.1	20.4	21.9	27.2	27.2	27.2	21.9	20.4	259
Tasks	FY	Prior	91	92	93	94	95	96	97	98	99	00	01	02	Total
Propulsion System Integration			(1)	(2)	(3)	(4)									
Flight Test Validation										(5)					

Objective:

- Develop Advanced Platelet Rocket Thruster
- Fully Reusable, Throttleable

- * Phase 3 Funding Estimate Provided by Air Staff
- * Actual Program Funding Requirement Due 2nd QTR FY92

Pay-Offs:

- High Performance 2-D Rocket Demonstrates ASO SEC ISP
- NASP Modular Platelet Engine Selected for SDIO SSTO Concept
- Reliable Electric Restart Via Laser Ignition System

Milestones:

1. System Design Requirements (9/91)
2. Rocket Configuration Freeze (9/92)
3. System Preliminary Design (4/93)
4. Technology Freeze Date (1/94)
5. X-30 First Flight (10/97)

HIGH SPEED AIRBREATHING PROPULSION SYSTEM

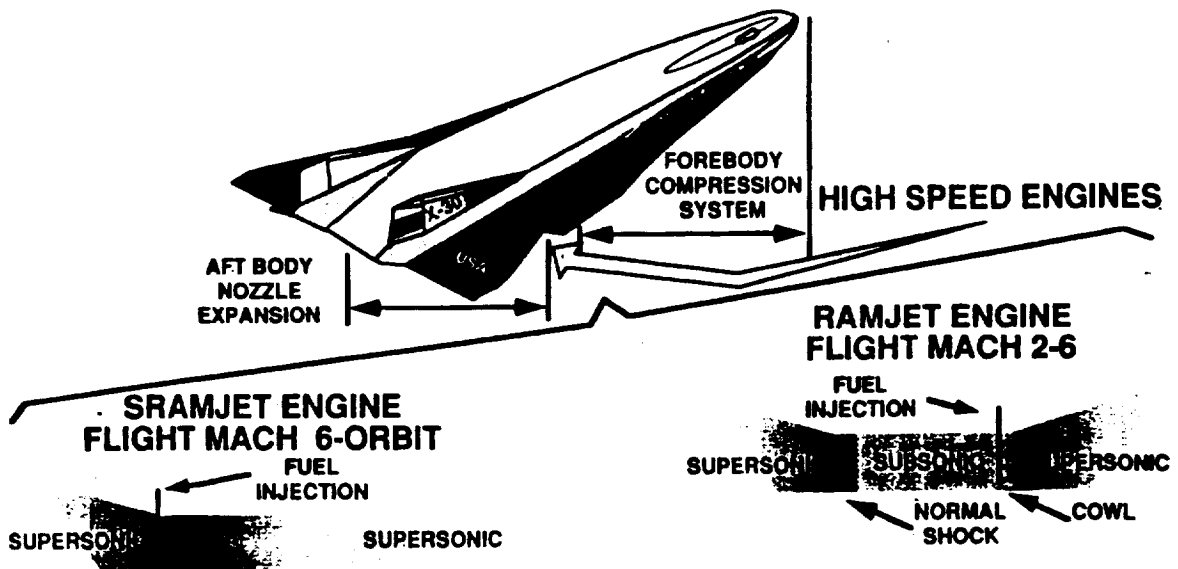

ORIGINAL PAGE IS
 OF POOR QUALITY

ORIGINAL PAGE IS
 OF POOR QUALITY

PROPULSION MODE COMPARISON

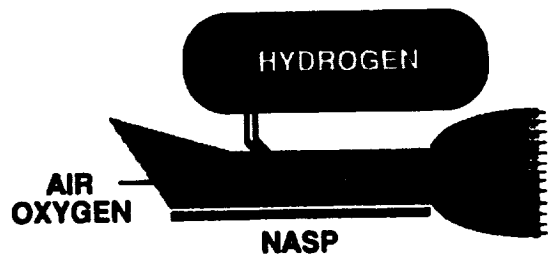
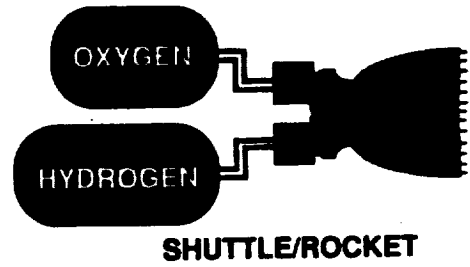
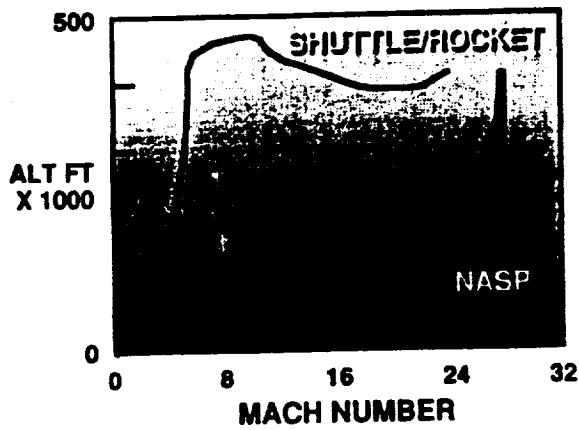

ORIGINAL PAGE IS
OF POOR QUALITY

NASP X-30 Propulsion Technology Status (Industry)
D. Kenison
NASP JPO

(Paper Not Received in Time for Printing)

19901221
N 9 2 - 2 1 5 3 5

NASA's HYPERSONIC PROPULSION PROGRAM:
HISTORY AND DIRECTION

628269
Rep.

Steve Wander
Code RF
NASA Headquarters
Washington, D.C. 20546

Research into hypersonic propulsion; i.e., supersonic combustion, was seriously initiated the Langley Research Center in the 1960's with the Hypersonic Research Engine (HRE) project. This project was designed to demonstrate supersonic combustion within the context of an engine module consisting of an inlet, combustor, and nozzle. In addition, the HRE utilized both subsonic and supersonic combustion (dual-mode) to demonstrate smooth operation over a Mach 4 to 7 speed range. The most impressive technological advances were made in the structures area, where a flight weight, actively cooled structure for the complete engine was built and tested up to Mach 7 enthalpies in the 8 foot High Temperature Structures Tunnel (currently referred to as the High Temperature Tunnel). In addition, separate aerodynamic tests were conducted in the Lewis Plumbrook facility. Flight tests were to be carried out on the X-15, but did not occur due to delays in the construction of the HRE and early cancellation of the X-15 program. While the HRE was fully successful in meeting it's two primary objectives; 1) development of flight weight actively cooled structures and 2) demonstration of internal thrust from a dual-mode scramjet, no attempt was made to address integration to a vehicle or to achieve useful installed thrust. As a practical propulsion system the HRE had three major drawbacks: 1) the axisymmetric centerbody design resulted in large surface areas to be cooled, limiting maximum practical Mach number; 2) the "drooped" inlet cowl, required to make the inlet operate properly, resulted in high installed cowl drag; and 3) the resulting external engine shape led to a fundamental integration problem with the airframe.

Consequently, the program turned it's attention toward defining an engine design that would have higher installed performance potential; i.e., reduced internal surface area, low external wave drag, and good vehicle integration characteristics. The objective was to develop and demonstrate the technology for such an integrated engine having a high Mach number capability by virtue of it's low internal surface area. In addition, it was felt that the high temperatures and resulting extreme structural design conditions associated with hypersonic flight would dictate fixed geometry or only modest variable geometry designs. Thus, the hypersonic aspects of the engine were emphasized and multi-cycle features deferred until mission requirements and low-speed operational characteristics were defined. After pursuing a number of approaches, these considerations resulted in three dimensional inlet/engine designs utilizing inlet/sidewall compression surfaces and a vertical throat. At about the same time (late 1960's), cruise and airbreathing launch vehicle studies were being completed by industry that featured two-dimensional inlets and turboramjet/scramjet engines. This led the Ames and Lewis Research Centers to focus inlet research on two-dimensional inlet designs involving large moving panels. However, because of the variable geometry requirements and presence of strong shock waves inherent to that design approach, these designs were considered impractical for high hypersonic Mach numbers.

Responding to the cancellation of the X-15 program and the HRE flight tests, Langley Research Center initiated studies in the early 1970's to focus technology on both hypersonic structures and propulsion systems. At about this time, propulsion ground facilities were also becoming available for direct connect and free jet tests over the Mach 4 to 8 speed range. Thus, a program was put in place that focused propulsion development on a Hypersonic Research Airplane (HRA). The HRA would be rocket boosted to hypersonic speeds and would cruise on dual-mode scramjet propulsion to demonstrate efficient installed performance. However, with the demise of hypersonic research in the mid to late 70's the HRA and most other hypersonic related activities were canceled, with only a small program being maintained in hypersonic propulsion. The propulsion program thus concentrated on fundamental supersonic combustion studies and free jet propulsion tests for the three dimensional fixed geometry engine design to demonstrate inlet and combustor integration and installed performance potential.

Starting in the early 1980's, studies were initiated with Lockheed, Pratt & Whitney, and the Lewis Research Center, to define a fully integrated vehicle and propulsion system that would lead to the design of an inlet for tests by NASA. That project was completed and produced the Mach 5 inlet that is currently being tested in the Lewis Research Center 10x10 tunnel. Several variations of the turboramjet engine were studied, all incorporating a two-dimensional, variable-geometry inlet system which was considered acceptable over the Mach 2.5 to 5 speed range. The turboramjet engine variations included an in-line turbojet and ramjet, a wraparound turboramjet, and an over/under turboramjet. The in-line engine was similar to the current Sanger engine, but was deemed unacceptable because only one engine could be operated at a time and because of concerns about the aerodynamic transition from turbojet to ramjet. The wraparound turboramjet was the industry standard for the 60's and 70's, but tended to have a large surface area that resulted in cooling problems at Mach 5. In addition, the central location of the turbojet put it in a "pressure cooker" during hypersonic flight. Results of the studies identified the over/under engine with a split inlet feature as the most desirable. The inlet external compression ramp doubles as a flow splitter when the turbojet is operating, forming separate inlets for the turbojet and ramjet. The result is a relatively compact engine with a minimum surface area in the ramjet flowpath, reducing its weight and cooling requirements at Mach 5. Separate turbojet and ramjet nozzles are contained in both the wraparound and over/under turboramjet engine and allow both engines to operate simultaneously so that sufficient thrust and a smooth transition can occur between the two cycles.

NASA's continuing efforts in hypersonic propulsion research through the 1970's enabled the development of supersonic combustion technology and helped to make possible the initiation of the NASP program. Interest in hypersonic research was revived with NASP in the mid-80's and required a dramatic expansion of these research activities. This has been particularly true with respect to the engine free-jet test facilities at the Langley Research Center where the contractor subscale engines have been extensively tested. NASP also helped bring about the reactivation of other test facilities such as the Ames 16 inch Shock Tunnel, the Langley Mach 18 Helium Tunnel, and the HYPULSE expansion tunnel at CALSPAN. Between the two NASP engine contractors, both classes of inlets and engines studied in the 60's and 70's have been addressed including two-dimensional and three-dimensional sidewall compression inlets. However, the NASP requirement for airbreathing propulsion from takeoff to near orbit forced an important extension of the earlier hypersonic propulsion work; multicycle operation over a wide speed range. Thus, the complexities of variable geometry requirements were coupled to the most severe mission environment possible where extreme heating conditions and a high mission sensitivity to propulsion efficiency and weight exists. Work performed by the NASP contractors has resulted in ingenious and, perhaps, breakthrough designs for implementing variable geometry within these engine shapes that had not been considered in the past. In addition, the importance and complexity of nozzle designs to recover hard earned thrust at hypervelocity speeds, where net thrust is only a small fraction of the gross thrust (i.e., high loss sensitivity) has been emphasized and appreciated. While the contributions from the NASP program have been impressive, efficient airbreathing Single Stage to Orbit (SSTO) vehicles are an extremely challenging problem requiring much additional research. However, NASP will be required to take an engineering approach to develop the X-30 within the near-term without the luxury of fully optimizing component design and performance, or the propulsion flowpath. Thus, the continuing need for a generic program to investigate and optimize alternative propulsion flowpath technologies, engine cycles, and fuel types.

Generic Hypersonic Propulsion Program

Two recent developments that most influence the application of airbreathing propulsion to hypersonic vehicles are 1) the NASP program which emphasizes airbreathing propulsion to orbit, and 2) research into endothermic hydrocarbon fuels which will provide cooling capacity up to flight speeds of Mach 7 or 8 with storable hydrocarbon fuels. Thus, interesting hypersonic propulsion initiatives exist for both hydrogen and hydrocarbon fueled applications. The Air Force Wright Laboratories (AFWL) also conducts research programs into hypersonic airbreathing applications and recently briefed the Scientific Advisory Board (SAB) Hypersonic Panel on their Hypersonic Technology Initiative plans. AFWL sees as their research priorities hydrocarbon fueled first stage launch vehicles and hydrocarbon cruise missiles both of which require a strong ongoing program into endothermic hydrocarbon fuels research.

Consequently, the NASA Generic Hypersonic Propulsion (GHP) program is designed to complement the NASP and AFWL programs through a balanced research program with focused augmentations in both hypervelocity research and lower speed (Mach 4 to 8) hydrocarbon fueled vehicle applications. However, within the current limited funding the GHP program will concentrate principally on basic tool building activities, with focused research into more efficient SSTO propulsion systems to complement the NASP program. These activities will continue to be the principle focus for the program in FY 1992/3. In addition, research up to Mach 8 will continue at a modest level utilizing existing propulsion facilities to explore more efficient approaches SSTO and Two Stage to Orbit (TSTO) airbreathing launch systems. The long-term program emphasis is described in the following sections.

Augmentation in the hypervelocity arena (Mach > 14) recognizes the importance of efficient airbreathing propulsion to space launch vehicle performance at high hypersonic speeds. At these speeds, the energy contained within the propulsion airstream becomes very large such that the energy added by the combustion of fuel represents only a small percentage of the energy contained within the flowpath. Net thrust then becomes the difference between two very large quantities, the stream thrust approaching the inlet cowl and the gross thrust from the nozzle exhaust. Therefore, losses within the propulsion flowpath will have a dramatic effect on net thrust and thus, overall vehicle performance is much more sensitive to propulsive performance in this speed regime. In addition, little research has been conducted at these speeds so that our understanding of the propulsion flowpath and supersonic mixing and combustion process is not nearly as mature as at the lower speeds (Mach 4 to 8). The hypervelocity program will strive to understand the propulsion flowpath chemistry and physics and devise means of minimizing component losses much like propulsion research conducted over the past two decades at lower speeds. Initially, research would be focused on the high speed end setting aside the constraining requirements of low-speed propulsion system performance. Once the flowpath and loss mitigation processes are better understood, that technology may be applied to further optimize the high Mach end of the SSTO propulsion system and may also be applied to propulsion system designs for the second stage of a TSTO launch vehicle or a cruise missile. Vehicles that only operate at the hypervelocity speeds (Mach 10 to 20) will have propulsion systems that could be fixed geometry and are not constrained by lower speed propulsion requirements. One focus of the program will be to explore innovative approaches for this class of vehicle, such as a detonation wave scramjet, to find ways to make substantial improvements in the performance potential of airbreathing launch vehicles. One centerpiece of such a hypervelocity program must be the development of advanced facilities to allow propulsion tests at the high energy levels associated with hypervelocity speeds. A near-term opportunity exists to achieve a significant increase in propulsion test capability by adding a "free piston driver" to the existing HYPULSE expansion tunnel. Other appropriate ground test capability also exists at the Ames Research Center in the 16 inch Shock Tunnel and the Direct Connect Arcjet Facility (DCAF). In addition, flight test augmentation will be required to provide critical data to provide ground based experimental test correlations and to validate analytical tools and Computational Fluid Dynamics (CFD) codes.

The planned hydrocarbon fuel augmentation will impact a number of hypersonic vehicle classes which have the potential to effectively utilize the heat capacity contained within endothermic fuels. With storable hydrocarbon fuels, vehicles can become much smaller and flight operations much easier. Again, this involves two classes of vehicles having propulsion systems of varying complexity; 1) multicycle engines incorporating a turbojet and ramjet or scramjet operating from takeoff to cruise or staging speeds, and 2) cruise missiles operating over a narrow Mach number range. Multicycle engines may be derived from the turboramjet cruise vehicle studies of the 1980's and will benefit directly from the Mach 5 inlet research currently being conducted at the Lewis Research Center. The over/under turboramjet engine is adaptable to replacing the ramjet flowpath with a dual-mode scramjet, significantly increasing the Mach potential of that engine to Mach 7 or 8. This potential results from the reduced pressure and heat load of the scramjet flowpath allowing a wider flight corridor and reduced cooling requirements. Missile applications may not be constrained by lower speed requirements and may therefore be readily adaptable to three dimensional fixed geometry inlets and other innovative concepts. The enabling technology for these classes of vehicles is an efficient dual-mode scramjet which burns endothermic hydrocarbon fuel. Inlet, combustor, and nozzle components all have unique operating requirements imposed by hydrocarbon fuels. Some feature,

such as a pilot, is required to allow the fuel to react and burn at supersonic speeds. The program will be fully coordinated with the AFWL to prevent duplication of effort particularly in the areas of mission analysis and fuels research.

HYPersonic PROPULSION: HISTORY

- Early work focused on fundamental studies of supersonic mixing and combustion, and the demonstration of that technology for an airframe integrated fixed geometry scramjet module from Mach 4 to 8.
- NASP built on and this work to develop multi-cycle engines that could operate from Mach 0 to 20, introducing extensions to supersonic combustion technology as well as variable geometry in a high heating environment.
- Recent AFWL studies into endothermic fuels opened possibilities of hypersonic applications for hydrocarbon fuels utilizing ramjet and dual mode scramjet propulsion cycles.

HYPersonic PROPULSION SYSTEM

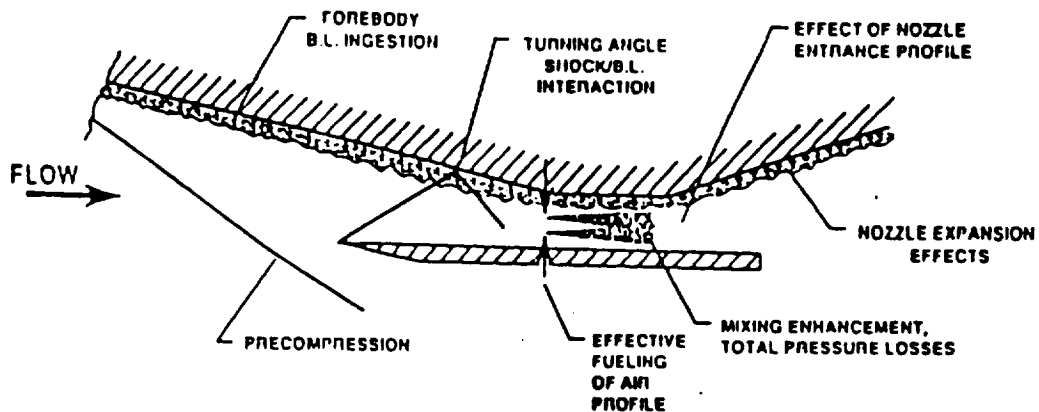

FUSELAGE FOREBODY

- SHOCK LOCATION
- DYNAMIC PRESSURE INCREASE
- LOCAL MACH NO. DECREASE
- BOUNDARY LAYER THICKNESS
- LONGITUDINAL & LATERAL STREAMLINES DEVIATION

COMBUSTOR

- EFFICIENCIES
- INJECTORS
- MIXING LENGTHS
- COOLING REQ'S

EXHAUST NOZZLE

- EFFICIENCIES
- MODULE INTERACTION
- FLOW STATES

INLET

- EFFICIENCIES
- STARTING CHARACTERISTICS
- VARIABLE GEOM
- INLETS INTERACTION
- BOUNDARY LAYER INGESTION

OVERALL PROGRAM GOALS AND OBJECTIVES

- **DEVELOP TOOLS TO ENABLE RESEARCH, DESIGN AND ANALYSIS OF ADVANCED HYPERSONIC PROPULSION SYSTEMS**
- **CONDUCT BASIC GROUND EXPERIMENTS AND SUPPORT FLIGHT RESEARCH PROGRAMS TO ESTABLISH FUNDAMENTAL UNDERSTANDING AND PERFORMANCE ENHANCEMENTS FOR HYPERSONIC PROPULSION SYSTEMS**
- **CONTRIBUTE TO AND INTERACT WITH MISSION ANALYSIS AND VEHICLE SYSTEM STUDIES TO DEFINE ENABLING PROPULSION TECHNOLOGIES FOR HYPERSONIC VEHICLES**

PROGRAM ELEMENTS

- **PROPULSION SYSTEM STUDIES**
- **INLET FLOW PHYSICS AND DESIGN**
- **COMBUSTOR FLOW PHYSICS AND DESIGN**
- **NOZZLE FLOW PHYSICS AND DESIGN**
- **PROPULSION FLOWPATH TECHNOLOGY**
- **EXPERIMENTAL AND COMPUTATIONAL CAPABILITIES**

PROPULSION SYSTEM STUDIES

GOALS AND APPROACH

DEVELOP CRITERIA FOR HYPERSONIC PROPULSION SYSTEM DESIGN AND PERFORMANCE

- MISSION/SYSTEMS STUDIES
- NASP PROGRAM INTERFACE
- NASA AND DOD PROGRAM INTERFACE
- DETAILED DESIGN STUDIES

INLET FLOW PHYSICS AND DESIGN

GOALS AND APPROACH

DEVELOP ENABLING TECHNOLOGY FOR HIGH PERFORMANCE HYPERSONIC INLETS

- FUNDAMENTAL FLOW PHYSICS RESEARCH
- SUB-SCALE MODEL TESTS
- JOINT DESIGN EFFORTS
- INLET PERFORMANCE ENHANCEMENT
- FLIGHT RESEARCH PROGRAMS
- HYDROCARBON FUELS STUDIES

COMBUSTOR FLOW PHYSICS AND DESIGN

GOALS AND APPROACH

DEVELOP ENABLING TECHNOLOGY FOR HIGH PERFORMANCE COMBUSTORS

- HIGH SPEED MIXING AND COMBUSTION
- FUEL INJECTION CONCEPTS
- HYDROCARBON FUEL CONCEPTS
- COMBUSTOR EFFICIENCY IMPROVEMENTS
- CFD CODE CALIBRATION
- FLIGHT RESEARCH SUPPORT

NOZZLE FLOW PHYSICS AND DESIGN

GOALS AND APPROACH

DEVELOP ENABLING TECHNOLOGY FOR HIGH PERFORMANCE NOZZLES

- NOZZLE LOSS MINIMIZATION
- SCRAMJET NOZZLE TESTS
- COMBUSTOR- NOZZLE INTEGRATION
- FLIGHT RESEARCH SUPPORT

PROPULSION FLOWPATH TECHNOLOGY

GOALS AND APPROACH

DEVELOP AN UNDERSTANDING OF AIRFRAME/ENGINE FLOW PATH AND ENGINE-COMPONENT INTERACTIONS, AND INVESTIGATE ALTERNATIVE ENGINE CONCEPTS

- COMPONENT INTERACTION EVALUATIONS
- SUB-SCALE ENGINE CONCEPTS
- NOZZLE-AFTERBODY INTERACTIONS
- LARGE-SCALE BOILER-PLATE ENGINE TESTS
- ALTERNATIVE HIGH MACH ENGINE CONCEPTS
- FLIGHT RESEARCH SUPPORT

EXPERIMENTAL AND COMPUTATIONAL CAPABILITIES

GOALS AND APPROACH

PROVIDE EXPANDED EXPERIMENTAL TEST CAPABILITIES INCLUDING ADVANCED DIAGNOSTIC INSTRUMENTATION; AND DEVELOP ADVANCED COMPUTATIONAL METHODS ADDRESSING PROPULSION COMPONENT DESIGN AND ANALYSIS

EXPERIMENTAL

- ADVANCED INSTRUMENTATION CONCEPTS
- FLIGHT TEST CAPABILITY ENHANCEMENTS
- FACILITY UPGRADES
- ADVANCED FACILITY CONCEPT STUDIES

COMPUTATIONAL

- CFD CODE CAPABILITY ENHANCEMENT
- INTERACTIVE ENGINEERING METHODS
- NOSE-TO-TAIL ANALYSIS METHODOLOGIES

PROGRAM FOCUS

- **PURSUE ENABLING TECHNOLOGY BASE FOR SCRAMJETS**
- **EXPLORE INNOVATIVE HYPERVELOCITY (M > 14) PROPULSION CONCEPTS**
- **DEVELOP MACH 4-8 HYDROCARBON FUELED ENGINES**

PAYOFFS

SCRAMJETS

- **PROVIDE CONTINUING RESEARCH DATA BASE, EXPERTISE AND FACILITIES FOR SUPPORT OF NASP**

HYPERVELOCITY

- **ACHIEVE INHERENTLY HIGHER ISP FOR AIRBREATHING PROPULSION SYSTEMS VS. ROCKET PROPULSION**
- **EXTEND HIGH PERFORMANCE RANGE OF SSTO**
- **OPTIMIZE INNOVATIVE CONCEPTS FOR 2ND STAGE AIRBREATHERS**

HYDROCARBON FUELS

(HIGH DENSITY, STORABLE FUELS)

- **INCREASE OPERATIONAL FLEXIBILITY**
- **REDUCE VEHICLE SIZE, WEIGHT AND COMPLEXITY**

CRITICAL RESEARCH ISSUES

HYPERVELOCITY

↳ HIGH SENSITIVITY TO LOSSES,
I.E. NET THRUST << GROSS THRUST

- INCREASED FUEL THRUST
- REDUCED INLET WAVE DRAG
- IMPROVED MIXING
- REDUCED MIXING, FRICTION AND HEAT LOSSES
- EVALUATION OF DETONATION WAVE ENGINES
- ALTERNATIVE FUELS
- REDUCED DISSOCIATION LOSSES IN NOZZLE AND COMBUSTOR
- MISSION STUDIES
- GROUND TESTING FACILITIES, INCLUDING INSTRUMENTATION
- CFD/TRANSITION/TURBULENCE ETC. TOOLS FOR $M \gg 1$

CRITICAL RESEARCH ISSUES

HYDROCARBON FUELS (ENDOTHERMIC)

- IGNITION/PILOTING
- FUELS/CATALYSTS/HEAT EXCHANGERS (INTEGRAL)
- MODE CHANGE (TURBO TO RAMJET TO SCRAMJET)
- INLETS WITH SUBSONIC PILOTING
- EMISSIONS/POLLUTION
- DUAL PHASE FUEL OPERATION
- HIGH TEMPERATURE TURBOMACHINERY
- COMPONENT/VEHICLE INTEGRATION

RESEARCH MILESTONES

PROPULSION SYSTEMS STUDIES

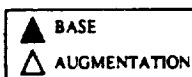
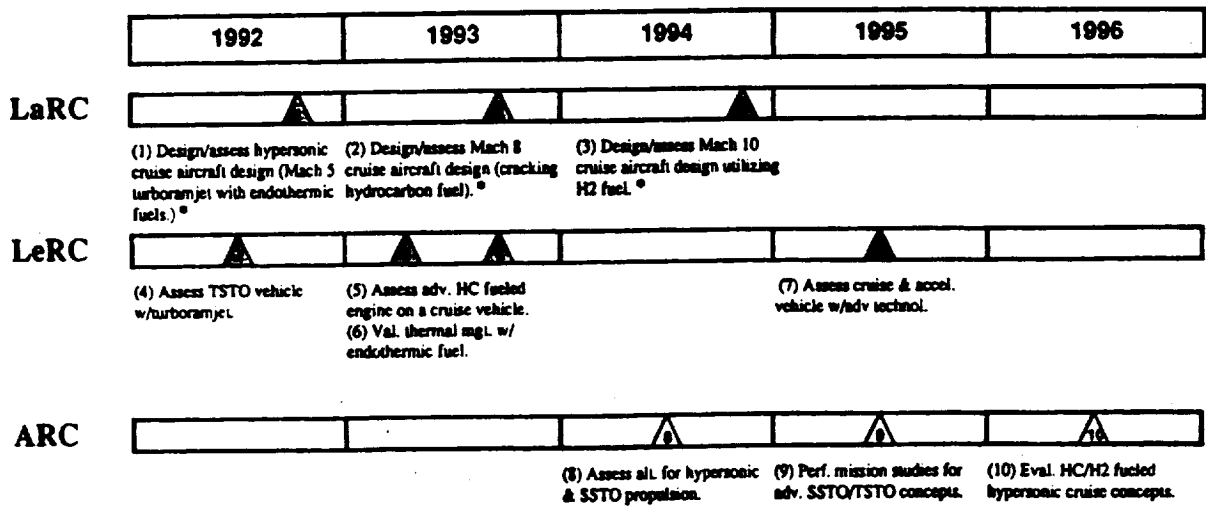

* RN money through RJ (Larry Hunt's work)

INLET FLOW PHYSICS AND DESIGN

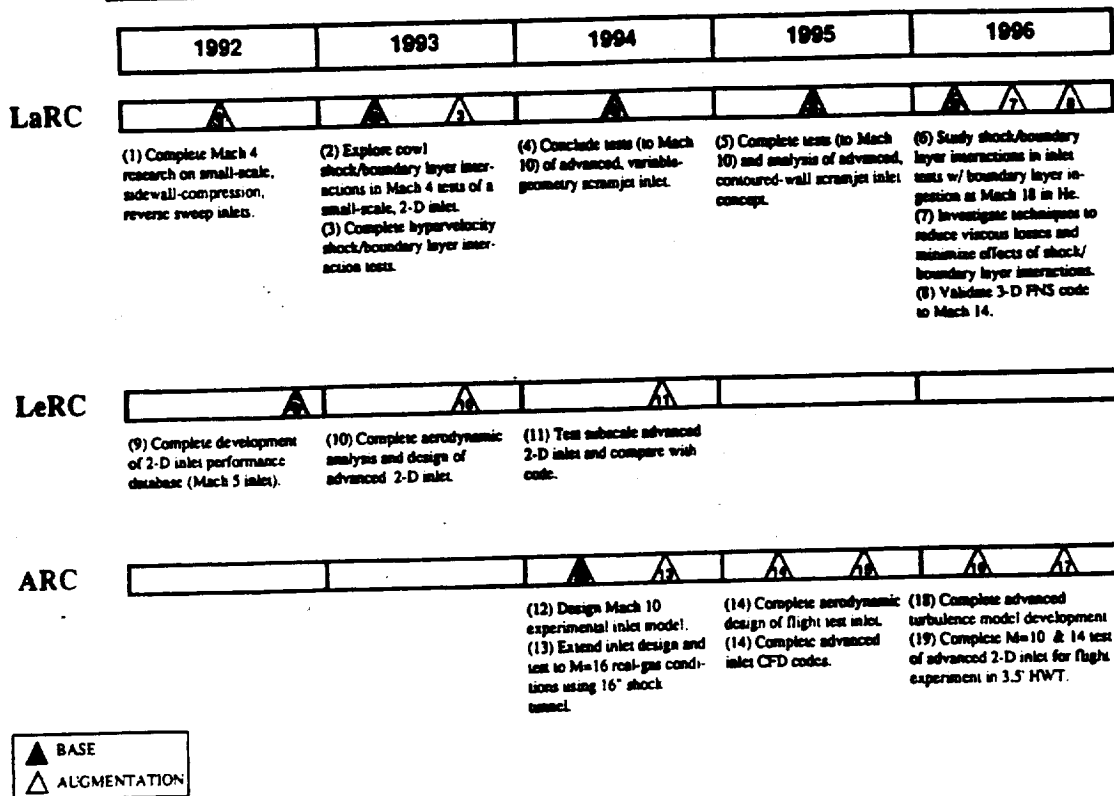

COMBUSTOR FLOW PHYSICS AND DESIGN

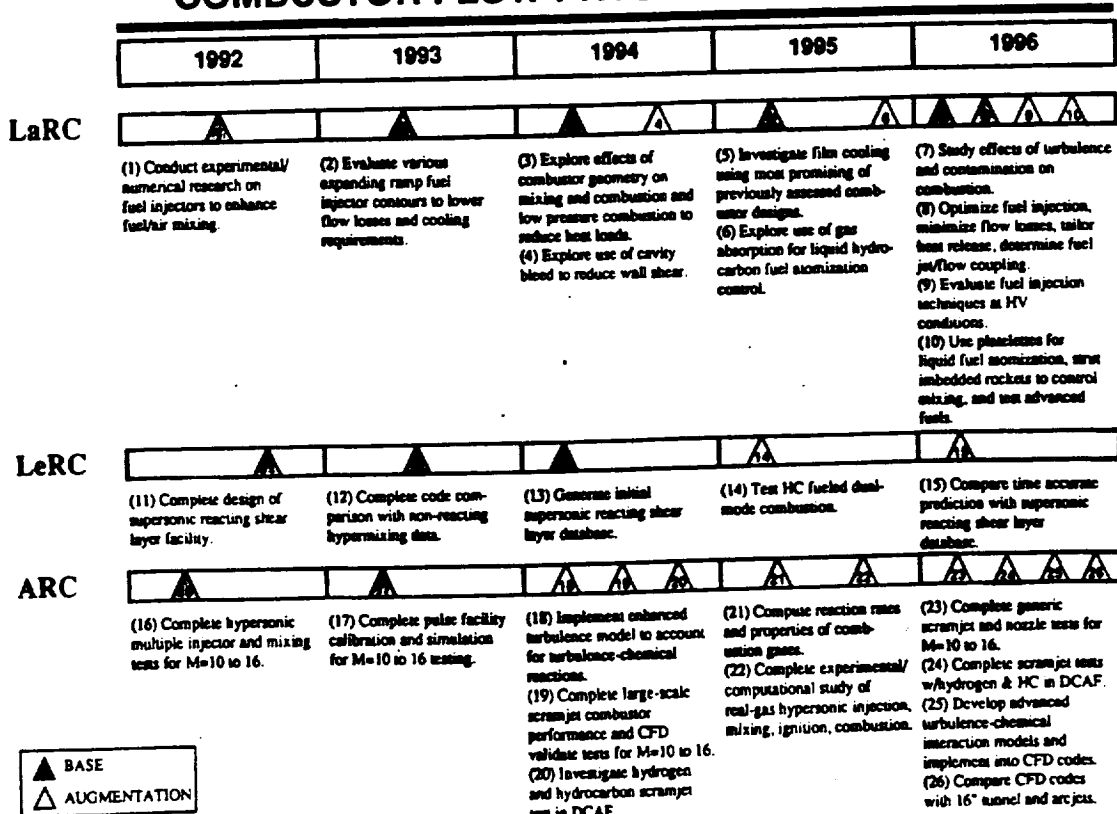



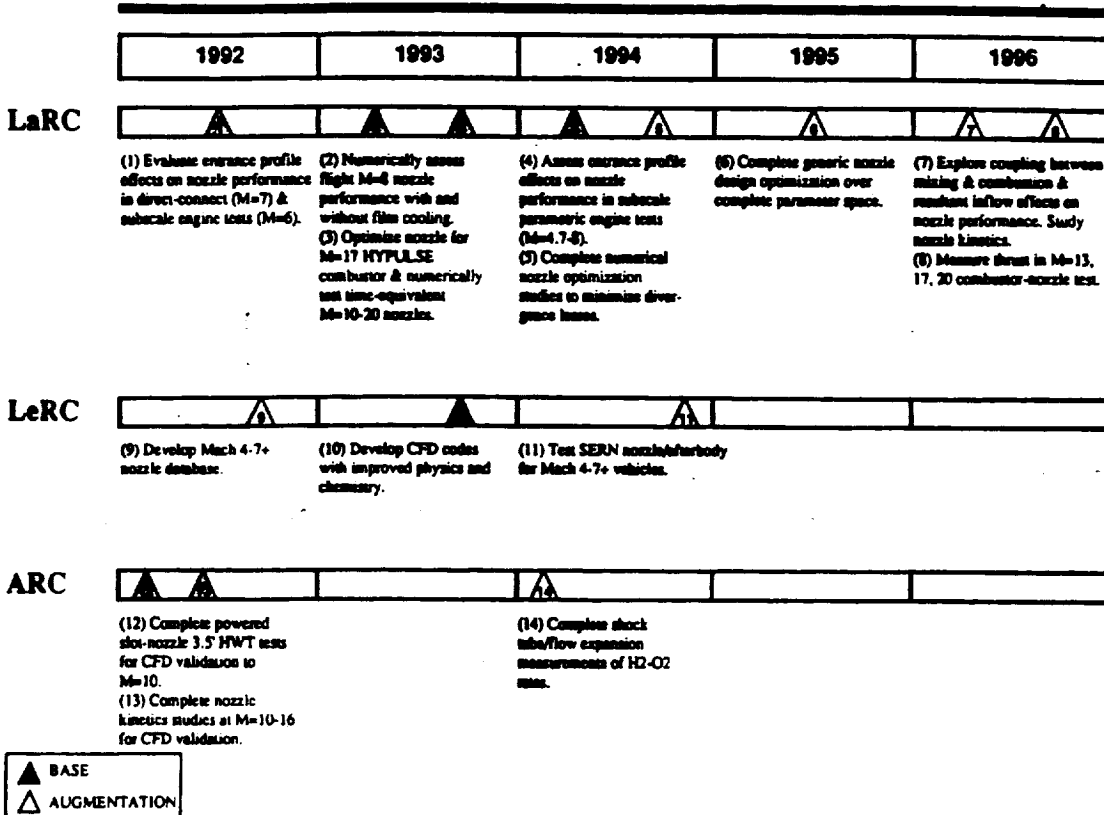



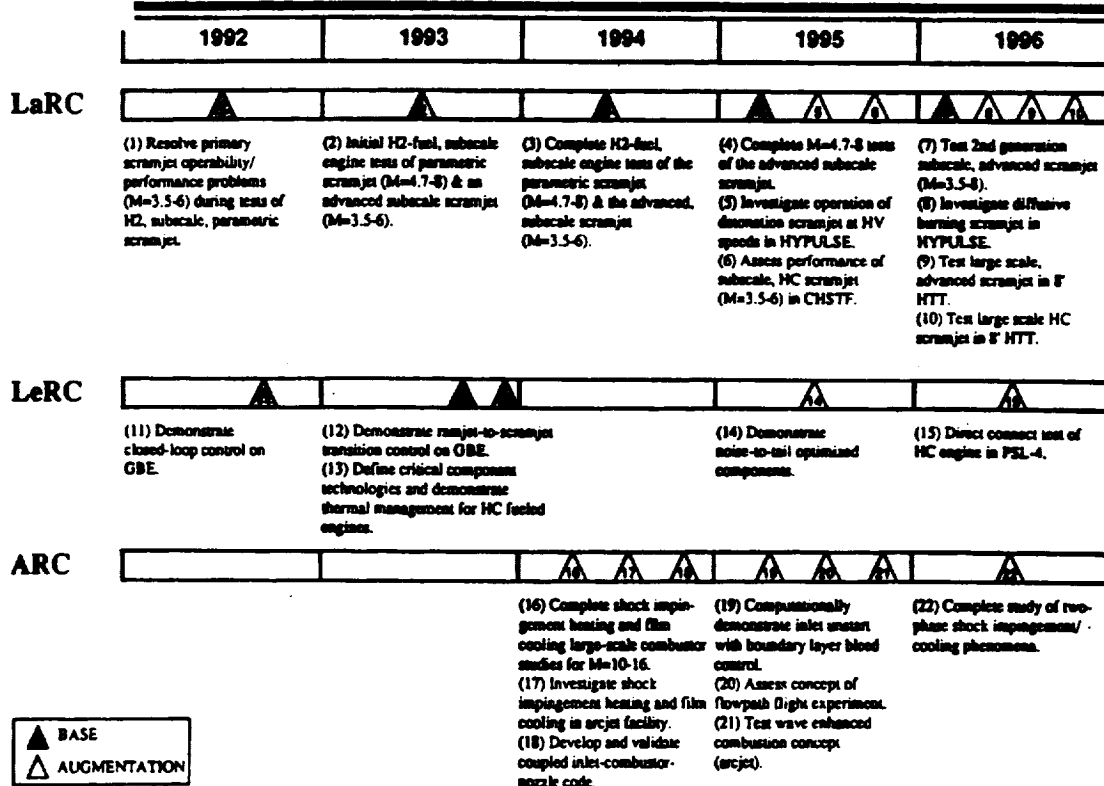







NOZZLE FLOW PHYSICS AND DESIGN



PROPULSION FLOWPATH TECHNOLOGY

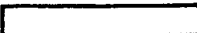

EXPERIMENTAL/COMPUTATIONAL CAPABILITY

	1992	1993	1994	1995	1996
LaRC	 <p>(1) Initiate technical evaluation of a large-scale Free-Piston Driven Expansion Tunnel (FPDET). (2) Demonstrate PLIF in HYPULSE, activate 30Hz CARS, develop MIE scattering technique for reacted silane. (3) Complete development of basic nozzle CFD analysis code & nozzle chemistry package.</p>	 <p>(4) Obtain HYPULSE calibration data at flight unit Reynolds No. using free-piston driver. Complete technical eval. of FPDET concept. (5) Demonstrate PLIF temp. mapping in HYPULSE & demo. the relief technique in DCSCTF. (6) Enhance inlet/nozzle analysis codes with improved algorithms, turbulence models and dynamic grid generation.</p>	 <p>(7) Develop pre-PER and cost estimates for FPDET. Prepare CoF process documentation/PER for FPDET. (8) Install HC fuel system in DCSCTF. (9) Obtain planar temperature PLIF using OH in DCSCTF & direct model force measurement in HYPULSE. (10) Develop 3-D CFD inlet/nozzle design optimization procedure.</p>	 <p>(11) Begin final design of FPDET. (12) Complete GPV studies using silane. (13) Complete development of large eddy simulation code for modeling high-speed reacting flows. (14) Complete validation of CFD predicted inlet performance, thrust & shear forces in nozzle simulating flight M=13-20.</p>	 <p>(15) Begin construction of FPDET. (16) Evaluate diode lasers for measurement of density and velocity. (17) Continue development of diagnostics for pulse facility. (18) Develop turbulence combustion models for Reynolds averaged Navier Stokes combustion code. (19) Validate inlet/nozzle code for inlet unstart, mode-to-mode interactions and with flight data.</p>
LeRC	 <p>(20) Validate RPLUS with hyper-mixing nonreacting data. (21) Compare enhanced RPLUS code with GBE.</p>	 <p>(22) Design non-interference air mass flow measurements. (23) Incorporate PDF turbulence model in CFD code.</p>	 <p>(24) HTP reactivation.</p>	 <p>(25) PDF modeling validated in CFD code.</p>	 <p>(26) Demonstrate prototype air mass flow measurement.</p>
ARC		 <p>(27) Develop/install optical diagnostics in pulse and arcjet facilities. (28) Develop/validate efficient inlet code for flight test development.</p>	 <p>(29) Develop/implement strategies for code efficiency, accuracy, robustness. (30) Develop CFD codes for arcjet flow modeling.</p>	 <p>(31) Experimentally quantify flowfield from arcjet facility. (32) Install laser diagnostics in arcjet facility for combustion measurements. (33) Validate CFD code for arcjet modeling.</p>	

▲ BASE
△ AUGMENTATION

HYPERSONIC PROPULSION DIRECTION

The base program will concentrate on tool building, and basic research in the following areas :

Flight Research - Provide appropriate ground tests and analysis to support experiment design and calibration efforts.

Hypervelocity Research - Conduct basic research studies for optimizing high-end performance, and explore specific high payoff approaches for application to advanced SSTO vehicles and the second stage of TSTO vehicles.

Hydrocarbon Research - Address basic research into supersonic combustion and piloting techniques unique to hydrocarbon fuels, and support integrated low-speed/high-speed propulsion system studies.

1992012294

N92-21536

BETA II, A NEAR TERM, FULLY REUSABLE, HORIZONTAL TAKEOFF & LANDING TWO-STAGE-TO-ORBIT LAUNCH VEHICLE CONCEPT

Leo A. Burkardt
NASA Lewis Research Center
Cleveland, Ohio

628270
10p.

A recent study has confirmed the feasibility of a near term, fully reusable, horizontal takeoff and landing two-stage-to-orbit (TSTO) launch vehicle concept. The vehicle stages at Mach 6.5. The first stage is powered by a turboramjet propulsion system with the turbojets being fueled by JP and the ramjet by LH₂. The second stage is powered by an SSME rocket engine. For about the same gross weight as growth versions of the 747, the vehicle can place 10,000 lbm. in low polar orbit or 16,000 lbm. to Space Station Freedom.

Design Goals

- Near-term staged system
- Doable technology levels
- Airbreathing first stage
- Rocket second stage
- Full reuseability
- All Azimuth launch
- Horizontal take-off and landing
- Bottom drop staging mode ease in handling and separation
- Integrated ferry capability

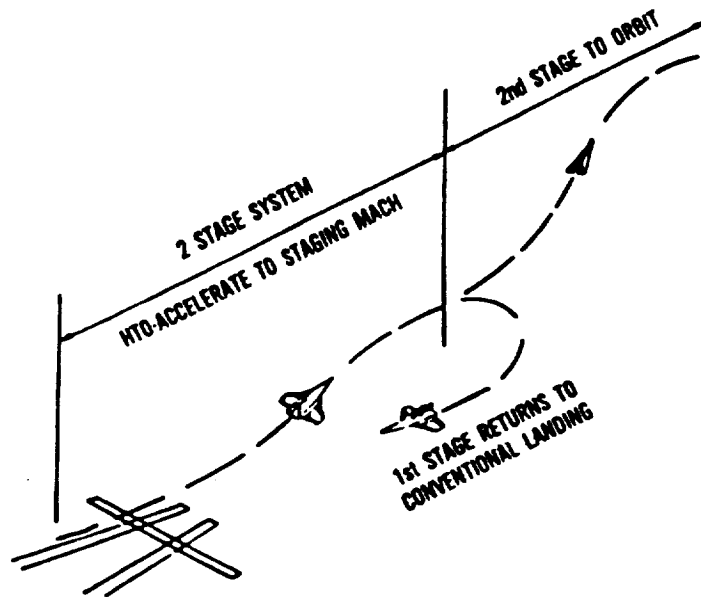

Evolution of BETA Airbreathing Launch Vehicle

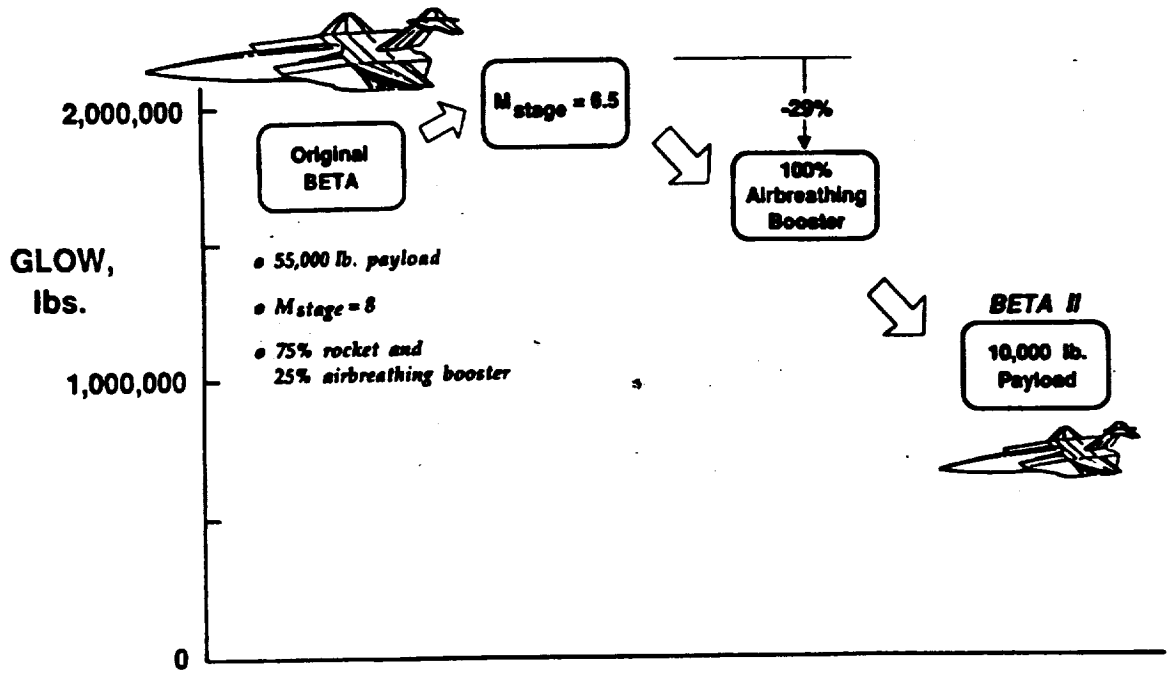

Typical Mission Profile

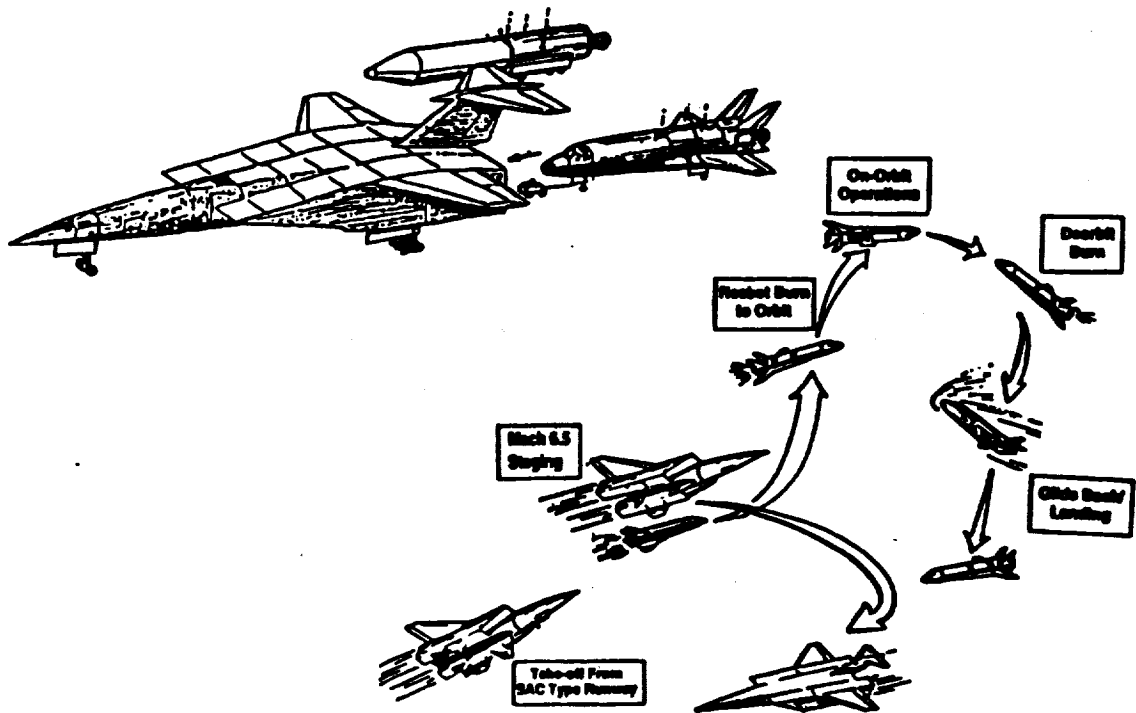

Optimum Trajectory

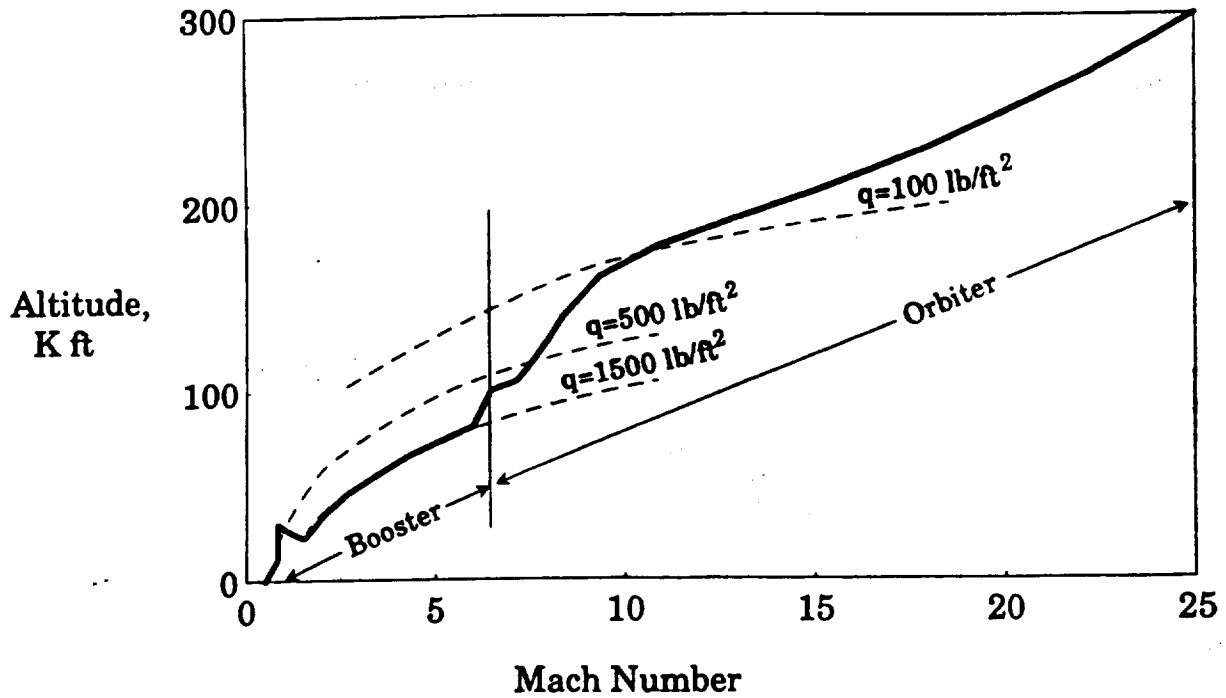

Beta II General Arrangement

BOEING/USAF/NASA

- Two Stage to Orbit
- Mach 8.5 Staging
- Ten JP-7 Fueled Turbojets
- Two Hydrogen Fueled Ramjets

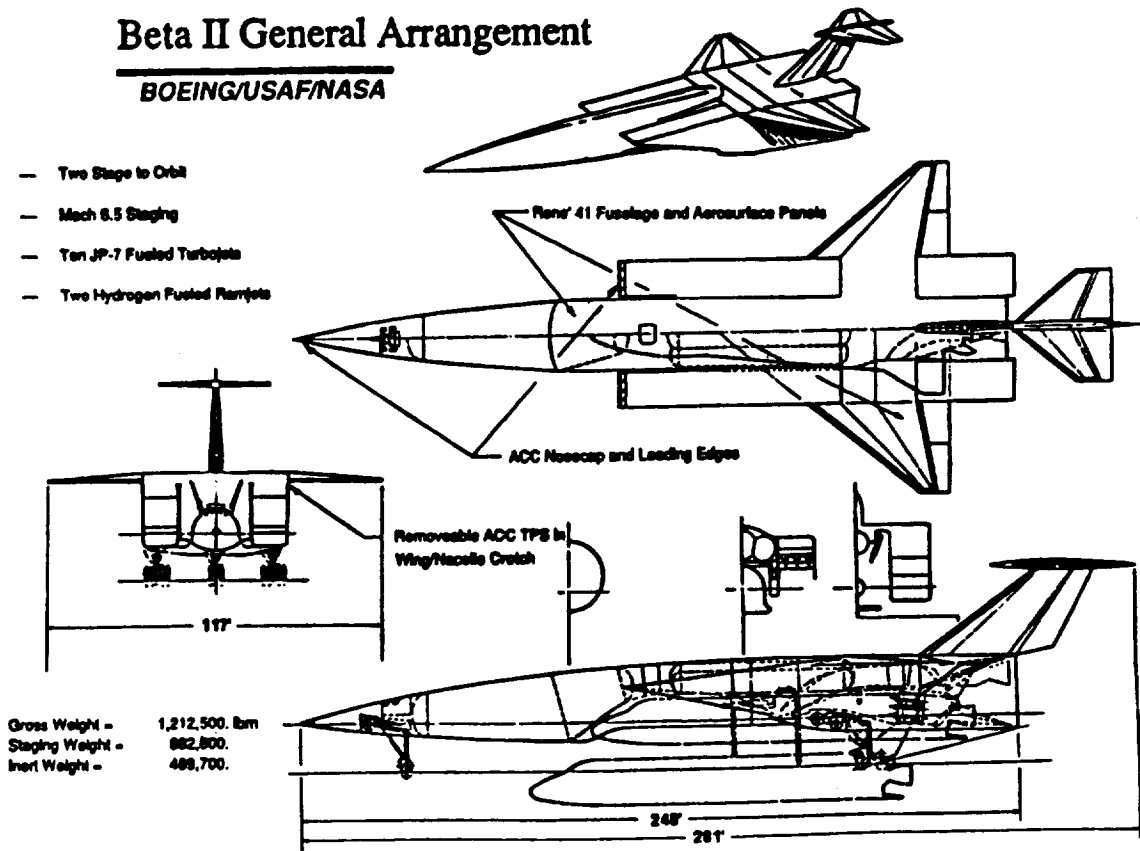

BETA ENGINE OPERATING SCHEDULE

Full Power
 Partial Power

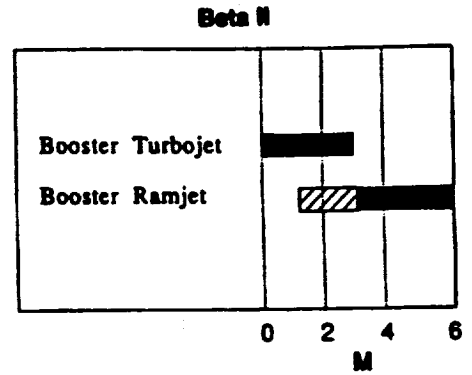
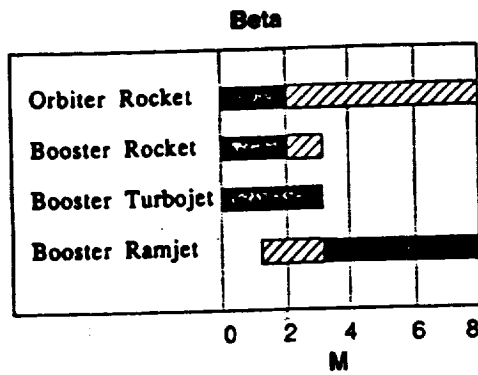

Beta II Booster Weights

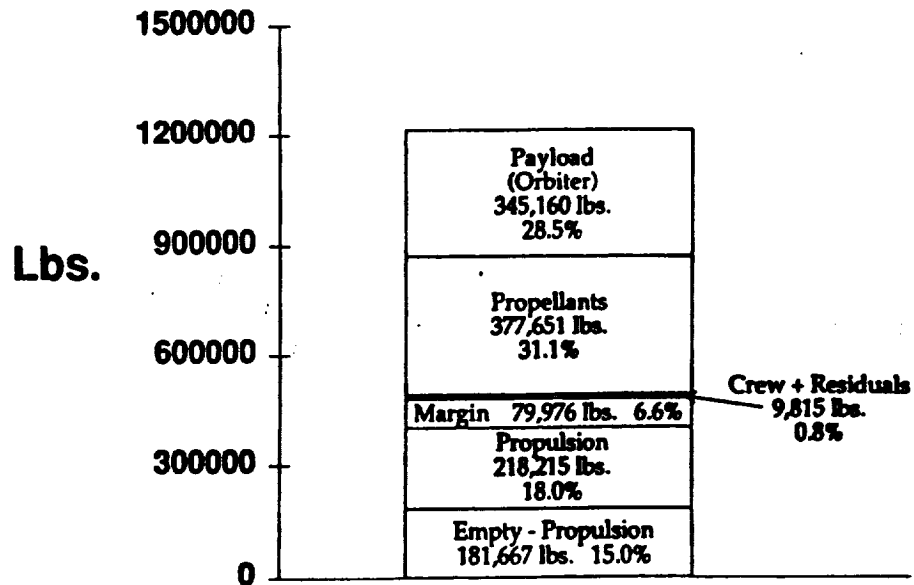

Beta II Nacelle at Selected Operational Modes

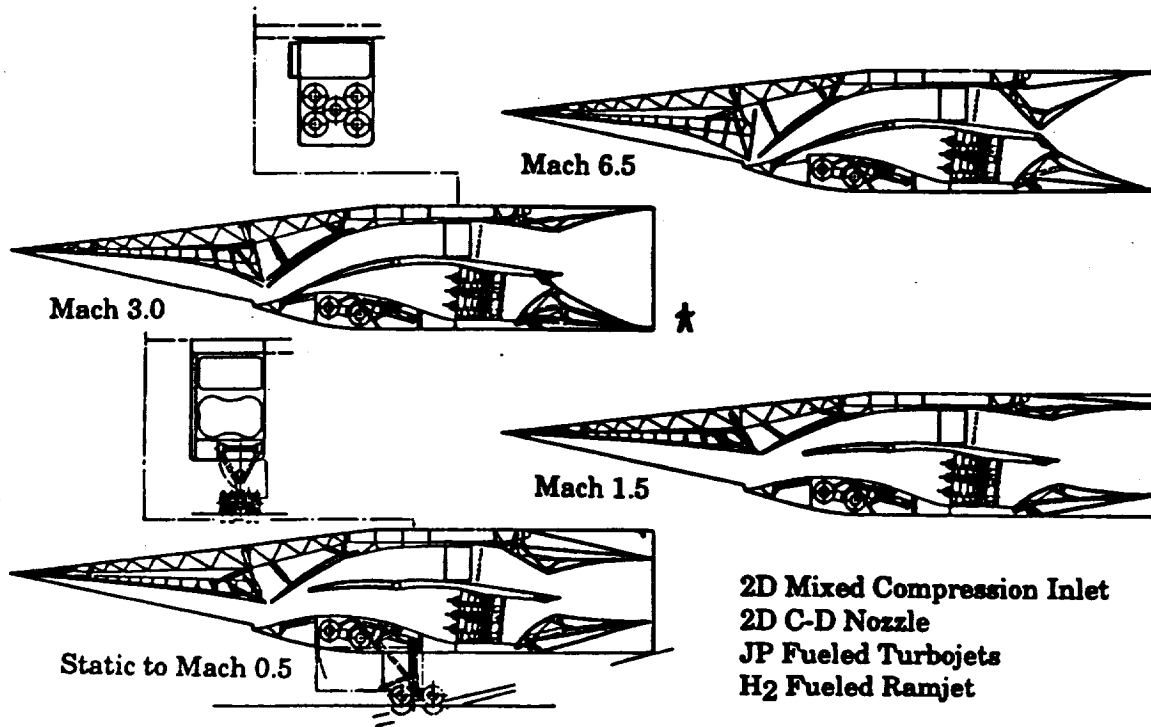

BETA Turbine-Bypass Engine Major Parameters

(Engine From Concurrent HSR Studies)

One-spool turbine bypass engine

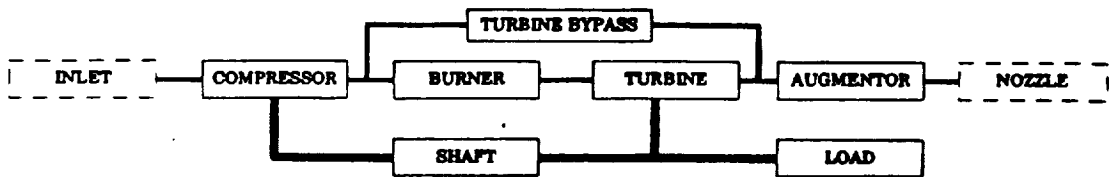

CORRECTED AIRFLOW 625 lbm/sec	OVERALL PRESSURE RATIO 20.4	MAXIMUM T41 3360 R	WEIGHT 6850 lbs	LENGTH 123 inches	DIAMETER 66 inches
----------------------------------	--------------------------------	-----------------------	--------------------	----------------------	-----------------------

Sea Level Static	Maximum Dry	Maximum Augmented
Net Thrust	55143 lbf	78400 lbf
TSFC	0.9429	1.6382



Mach 6.5 Staging Beta Orbiter

BOEING/USAF/NASA

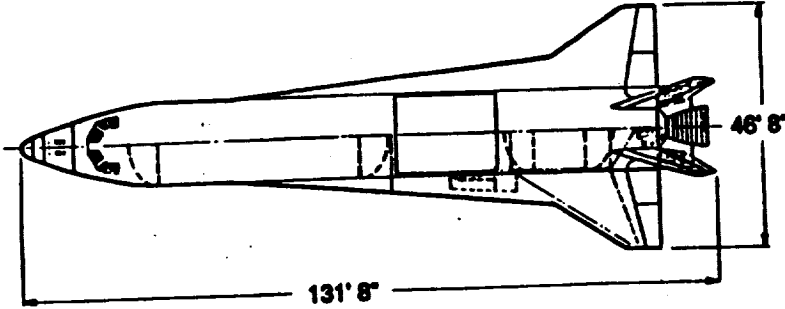

- 10 klb Payload to 120 x 120 nm Polar LEO
- All LOX-Hydrogen Propulsion
- 345,160 lb Gross
- 61,444 lb Inert
- $\lambda=0.811$

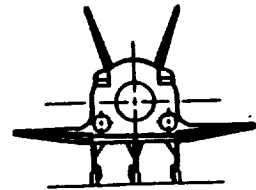
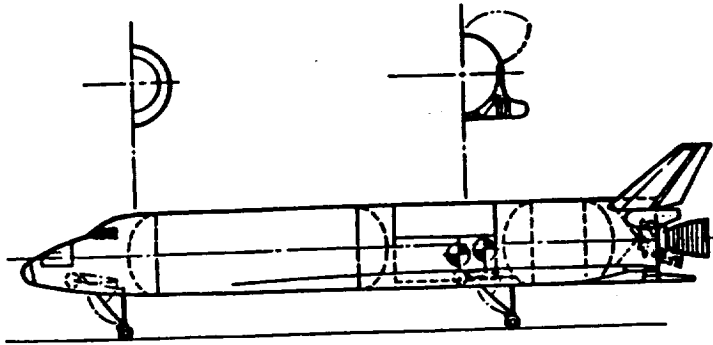

Beta II Orbiter Weights

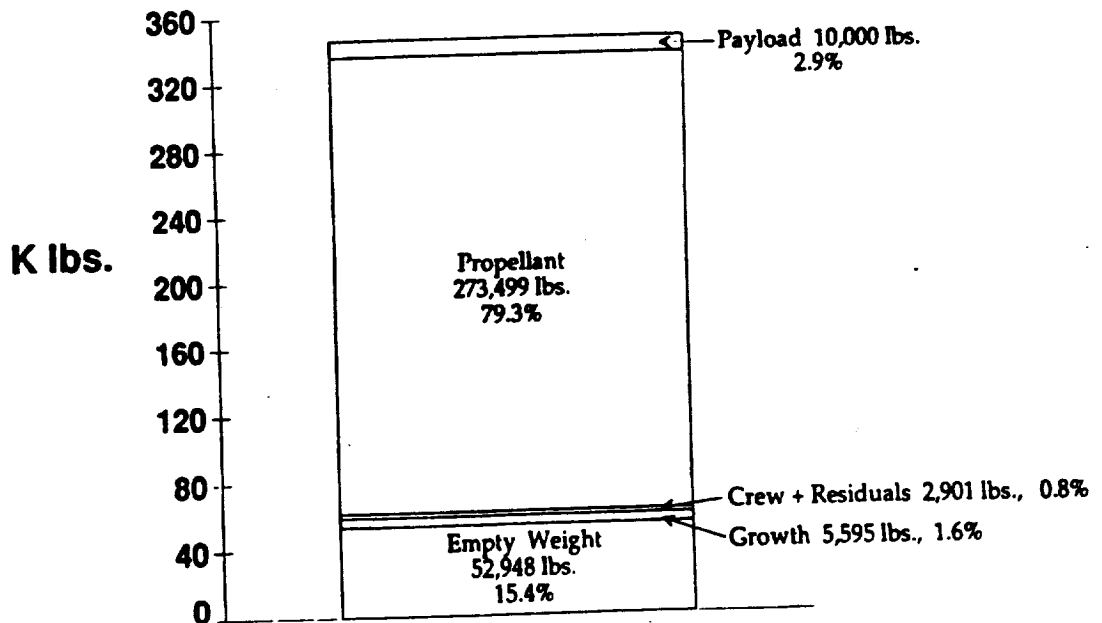

BETA II

- **Viabile and robust**
 - Conservative design, structures, materials
 - Minimum technology development
 - 20% growth margin built in
 - 747 weight class

- **Potential for low cost operation**
 - Simple stage mating
 - Airplane-like operations (intact, safe abort)
 - Fully recoverable
 - No ferry aircraft required

- **Versatile**
 - 10K — polar
 - 10 men + 10K — space station
 - 30K — space station (expendable 2nd stage)
 - All weather launch
 - M 4 - 6 research aircraft (booster)
 - Carrier for airbreathing M 6 - 25 research vehicle
 - Multi-mission vehicle

Advanced Manned Lanuch System (AMLS) Prop. Status
John R. Olds
NASA Langley Research Center
Hampton, VA

(Paper Not Received in Time for Printing)

1992012005
628272
8p.

N92-21537

INTERNATIONAL AEROSPACEPLANE EFFORTS

Dr Charles A. Lindley
18900 Pasadero Dr,
Tarzana, CA 91356

ABSTRACT

Although the U.S. began the reusable space booster effort first in the late 1950's, we no longer have an exclusive field. All the technologically advanced nations, and several groups of nations, have one or more reusable booster efforts in progress. Table 1 gives some suggestion of the number of entries in the field. The list is somewhat misleading, because it includes both fully reusable and partially reusable boosters, both manned and unmanned, and both flight test and operational proposals. Also, not all are funded, and only a few will survive. Let's look at the more likely candidates, country by country.

FRANCE/ESA: Probably the first foreign competitor to become operational will be the French Hermes, funded by European Space Agency (ESA). Hermes (Figure 1) is a mini-shuttle, to deliver 3 men and about 3,000 lbs of payload to the Columbus Space Station, and serve as a back-up to our Shuttle. Initially launched on an expendable Arien 5 booster, it should cost much less than a shuttle launch, because of the small size, and the low costs of the Arien 5.

Hermes is funded by ESA for \$4.5 B, and scheduled to fly in 1999. Most European nations are participating. It is in final design, and fabrication could begin as soon as 1993. The design is generally low technological risk, although monolithic SiC/SiC is under consideration for the lower heat shield.

Later plans would mate the Hermes to the "Star" reusable booster. The lower stage is a Mach 6 air-breather, with the Hermes and an expendable upper stage nestled in the upper surface. There also are designs and plans for full Aerospaceplanes after the year 2000.

GERMANY/ESA: The system most likely to follow the Hermes is the German Sanger design, (Figure 2) a two stage, fully reusable booster, that has been in design and technology development since 1987. The lower stage would be a Mach 6 hydrogen-fueled turboramjet, that could later be converted to a hypersonic transport design. There are to be two reusable rocket upper stages, CARGUS, a 17,000 lb. payload

cargo carrier, and HORUS, with identical mold lines, for personnel deliveries. The lower stage supersonic cruise capability will allow offset launches over the Equator or the Indian Ocean from bases in Europe.

A lower stage flight test vehicle, the "HYTEX" will be flown first. The technical risk on Sanger should be reduced by these flight tests. The regeneratively cooled turboramjet development will be difficult, but test engines have been running for about 4 years now.

In the vehicle, they plan extensive use of Li/Al, Gr/Ep, and SiC/C, but no Ti/Al components. The mass fraction demands should not be excessive with two stages.

The Sanger is in Phase 1b design, with over \$1 B funding to date. It's fate depends upon eventual ESA funding to a total estimated at \$12 B. There are funding problems, resulting from Germany's expensive rescue of East Germany, and from overruns of Hermes. Meanwhile, Germany is building political support for Sanger by negotiating subcontracts with practically all members of the European Community.

GREAT BRITAIN/ESA(/USSR): The initial British candidate was the HOTOL. This was a single stage-to-orbit, unmanned vehicle, with air-breathing engines convertible to rocket operation. The engine was a hydrogen fueled, pre-cooled air turbo-rocket, of unspecified variety, by Rolls-Royce. The elimination of the pilots, and some other design choices, may have made single stage performance possible,

The technical risk was considered higher than the Sanger, although the engines might have been easier because of the precooling. The British were unable to fund it heavily, and it appeared to be losing the competition with Sanger for ESA funding.

At this point, in 1989, the Soviets made a dramatic proposal; mount your Hotol on the back of our Anatov 225 and we'll launch it at Mach 0.8 and 30,000 ft. The Anatov is the world's largest transport (Figure 3, with the HOTOL), and will lift at least 550,000 lb externally. It has structural hard points for such external payloads, and twin tails to provide launch clearance. The Soviets added an offer to provide operating Lacerocket engines for the HOTOL, and high temperature parts made of Ti/AL, C/SiC, and other materials wherever they will improve the HOTOL. They might buy Rolls-Royce turbo-fans to increase the lift capability. A year and a half of design studies resulted in a proposal to ESA last year. The present design replaces the HOTOL air-breathers with very high performance Soviet rockets, and increases the GLOW to use the Anatov's maximum.

The Soviet capability in materials and engines that is now becoming more visible is outstanding. And the fact that the lower stage of this system is already operational, and much of the engine development work is done, could lead to a very low cost reusable booster solution.

If the ESA decision is delayed a year or two, this proposal might seriously challenge the Sanger. Questions such as the former USSR's economic and political condition,

and their relation to the European Community, will be at issue.

USSR (PAST): The capability and past attainments of the former USSR suggest a large international role for them in the future, when their political and economic problems are under control. Paul Czysz may have covered these matters before this presentation, so we'll only review here.

They flight tested LAPOT and other lifting body reentry vehicles like our X-20 in the 1960's. Their "50/50" TSTO design looked almost identical to the French "Star", but the lower stage is said to have flown to Mach 6 in 1975. They flew the Buran Shuttle unmanned in 1989, but may never bother to man it. Stage recovery capabilities are incorporated in the huge Energia booster, but may or may not be implemented.

They have been operating LACE engines on the test stand since 1975. Their high temperature materials, such as RSR and metal matrix compounds appear to be somewhat ahead of ours. Many production parts of these materials are incorporated in their Shuttle, including C/SiC leading edges.

They could become a very competent participant in the reusable business, most likely with a Western partner.

JAPAN: The Japanese started late in the reusable booster business. Their Hope mini-shuttle (Figure 4) is to be an unmanned vehicle to fly in 1996. It will be used for deliveries to and from the Japanese space station module, and for space experiments. The Himes is a smaller flight test vehicle. The follow-on program plans to fly a full Aerospaceplane by 2006 (Figure 5).

They have committed long-term funding of ~\$5 B at ~\$900 M per year to a very broad and deep technology development program. There are material developments in high temperature materials, including SiC coating on C/C for leading edges. They have been flight testing small models of the HOPE configuration to gain experience with flight controls and thermal protection systems. They are also reported to have made a very large offer to the USSR to buy rights to a large block of engine designs.

The Japanese have had a Lacerocket running for 5 years. They are also ground testing the Otrex engine, a precooled Mach 5 turbo-rocket with afterburner, which gives them a footing in our RBCC world. They also have a design for a Scramlace with a unique LACE fuel economizer device, and are starting component technology development for it.

The Japanese consider this effort part of a long-range national plan to move into high technology industries for the future betterment of their nation. They assume that partnership arrangements with the West will become available when they prove their competence. Unlike most participants in the race, they do not appear to feel any economic stress from carrying the costs, so they are likely to stay the course.

CONCLUSIONS: All the technologically advanced nations have an effort under way in this area. They cover most reasonable varieties of configuration, size, and technical risk (Figure 6). While there may be a world need for more than one system, some of these efforts must fall by the wayside. In recognition of this fact, and of the financial stress on several national budgets, there is much negotiation going on to "split up the pie". This is occurring, not only between nations, but even more between multinational corporations. As a result, where some critical technology might be lacking in one nation, it can surely be obtained by international dealing.

It is impossible to determine which reusable boost programs will succeed, and with what nation's sponsorship. But it seems clear that someone will succeed. The world will have one or more reusable space boosters at or near the year 2000. It is possible, but not likely, that the U.S. will be the sole owner of this capability. What this means for us, politically, economically, and militarily, is very difficult to foresee.

INTERNATIONAL REUSEABLE BOOSTER PROGRAMS

NATION	VEHIC	STAGE	RECOVER	BOOST	STATUS: T/O		COMMENTS
					MANNED	DATES	
USA	SHUTTLE*	2	N	N	1983		VTOHL RECOVERS UPPER ENGS & P/L
	NASP	1	Y	Y	T/2005		HTOL A/B; M = 12
	SDIO	1	Y	Y	D/1996		VTOL? ROCKET DESIGNS
	SEALAR	2	Y	N	T		VTOL SEA-BASED
USSR	50/50	2	Y/N	Y/N	T/1975		HTOL FLEW MACH 6
	ENERGIA	2	Y/?	N	(?)T		VTOL PROVISION FOR CHUTES
	FLYBACK*	2	Y	N	D		VTOHL WINGED
	BURAN*	2	N	N	O/1992/		VTOHL RECOVERS P/L
	LAPOT*	2	N	N	D/T		VTOHL RECOVERS P/L
	AN225/HOTOL2	2	Y	Y/N	D~1997		HTOL JOINT WITH GBR
GBR	HOTOL	1	Y	N	D~1997		HTOL ESA COMPETITION
	AN225/HOTOL2	2	Y	Y/N	D~1997		HTOL JOINT WITH USSR
GERM	DORNIER	2	Y	Y	D~2000		VTOHL DARK HORSE
	SANGER	2	Y	Y/?	D~2005		VTOL ESA COMPETITION
	HYTEX	1	Y	Y	D~1994		HTOL FLIGHT TEST
FRANC	HERMES*	2	N	N	D~1997		VTOHL MINI-SHUTTLE
	STAR-H	2	Y/N	Y/N	D~2000?		HTOL BOOSTER FOR HERMES
	ASP	1	Y	Y	D?		HTOL A/B; DESIGN STUDIES
JAPAN	HIMES*	2	N	N	1994		VTOHL FLIGHT TEST
	HOPE*	2	N	N	1997?		VTOHL MINI-SHUTTLE
	ASP	1	Y	Y	D~?		HTOL A/B; DESIGN STUDIES

INTREUSA

TABLE 1

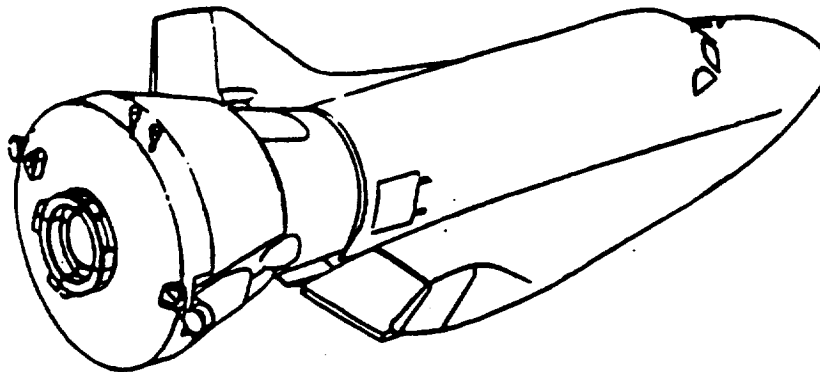

FIGURE 1. - HERMES AND EQUIPMENT MODULE.

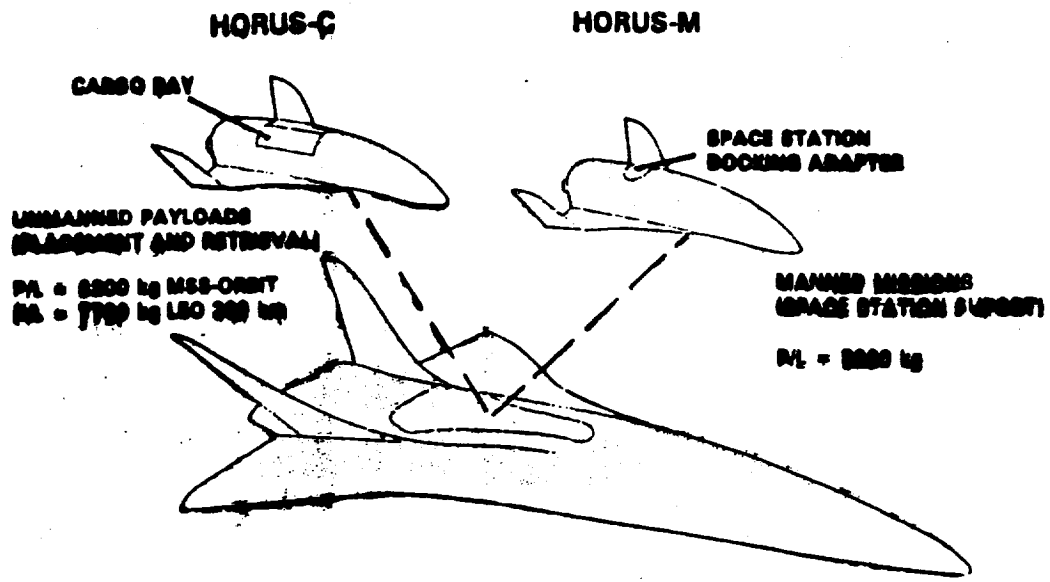

FIGURE 2. - SANGER SYSTEM CONFIGURATION.

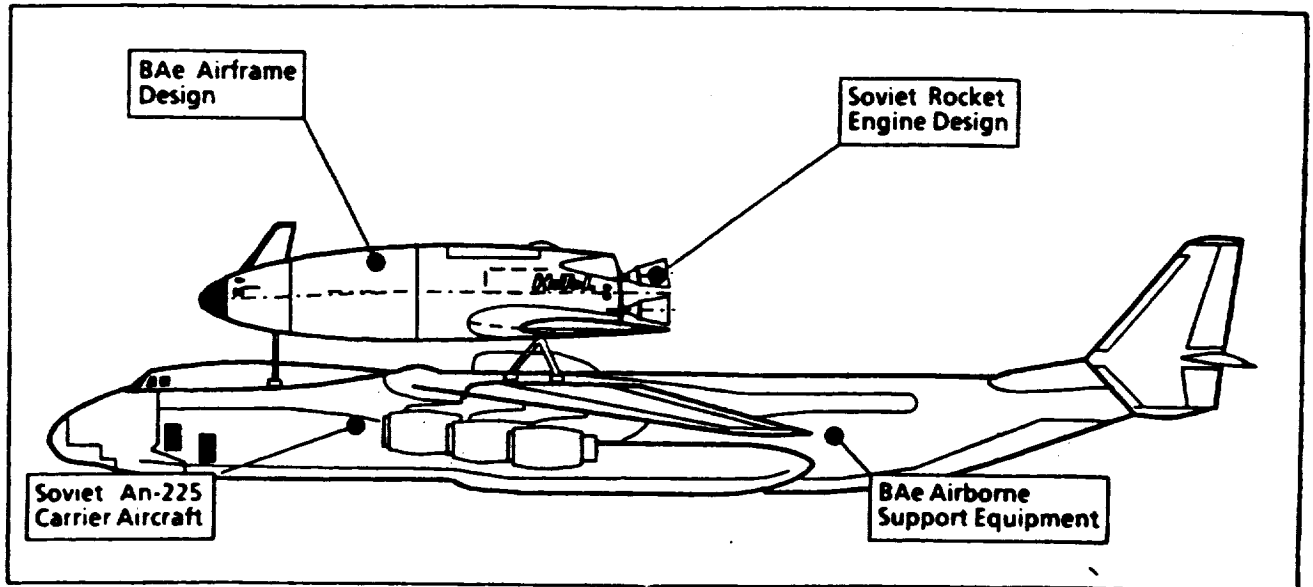

FIGURE 3. - ANATOV/HOTOL CONCEPT.

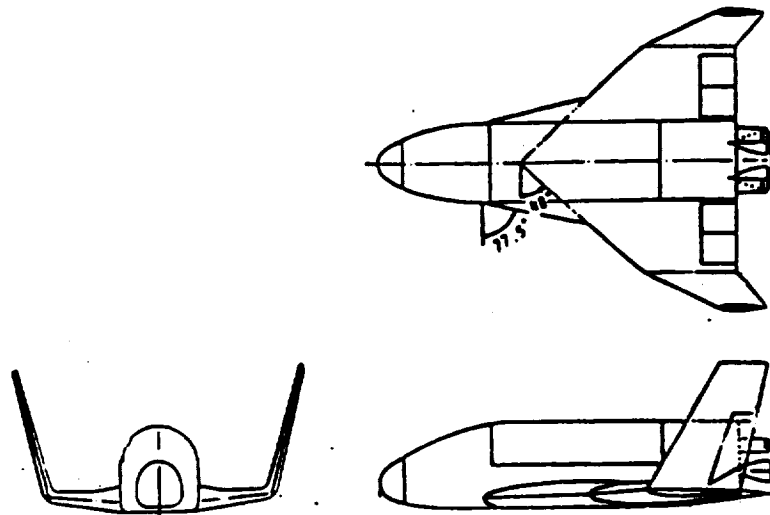

FIGURE 4. - HOPE MINI-SHUTTLE.

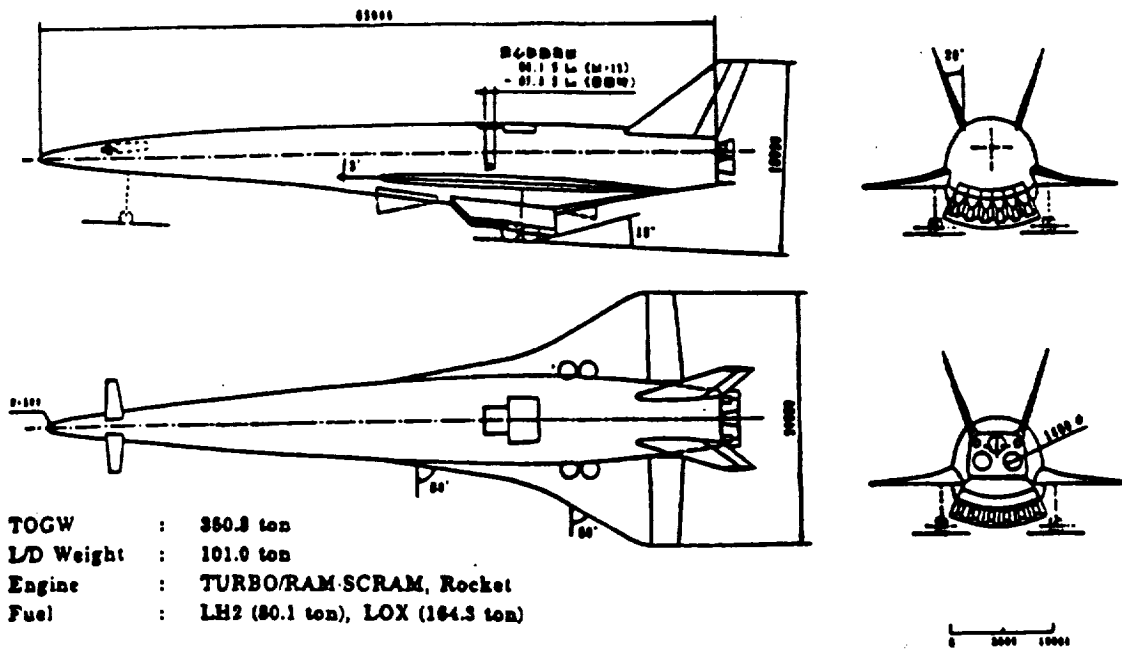

FIGURE 5. - JAPANESE SSTD CONFIGURATION.

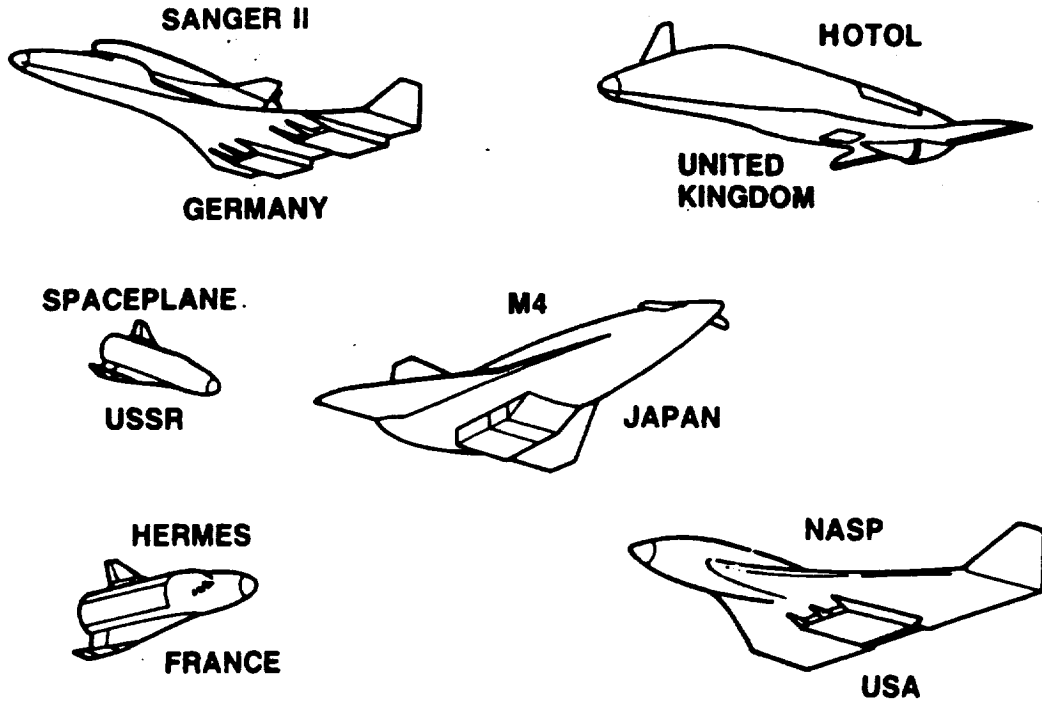

FIGURE 6. - ADVANCED SPACE TRANSPORTATION CONCEPTS.

Astronautics Corporation of America
Technology Center
5800 Cottage Grove Road
Madison, WI 53716
(608)221-9001

April 1988
March 1992 (Revised)

Technical Summary

**A Review of Findings of a Study of Rocket Based Combined
Cycle Engines Applied to Extensively Axisymmetric Single
Stage to Orbit Vehicles**

Prepared by:
Richard W. Foster



N92-21538

BACKGROUND

This technical summary was prepared in early 1988. It is based on the findings of a study carried out for the USAF Astronautics Laboratory by Astronautics Corporation of America and the Martin Marietta Aerospace Group (MMAG). The findings of this study are reported in:

Foster, R.W., Escher, W.J.D., and Robinson, J.W., Air-Augmented Rocket Propulsion Concepts, Final Report, USAF Astronautics Laboratory Report AFAL-TR-88-004, April 1988

PLACING THE VEHICLE STUDIED IN CONTEXT WITH OTHER ALTERNATIVE

Two figures are presented on the following page. The first figure defines, by illustration, what we mean by "Extensively "Axisymmetric" and "Non-Axysymmetric" vehicle configurations. The second figure places Rocket Based Combined Cycle (RBCC) propelled "Extensively "Axisymmetric" vehicles in context with all-rocket and other airbreathing orbital vehicles.

Placing the Study Vehicle in Context

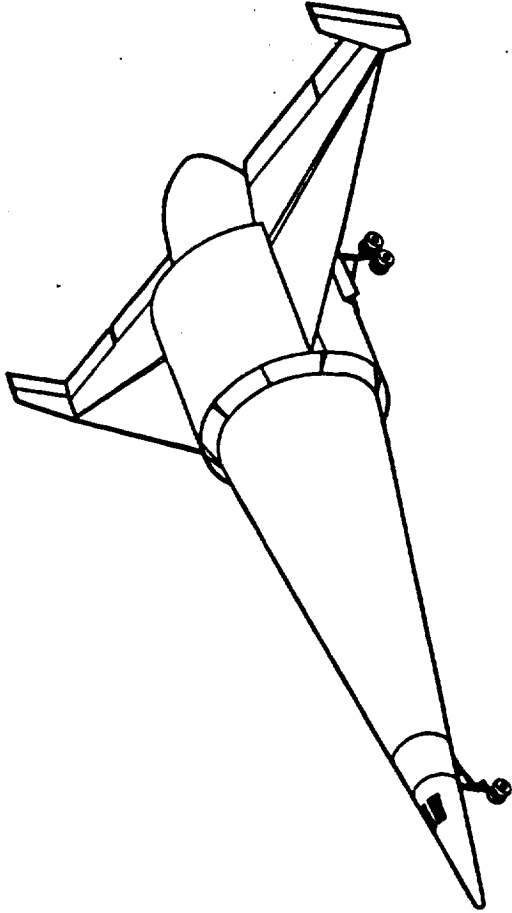

Form: Extensively Axisymmetric

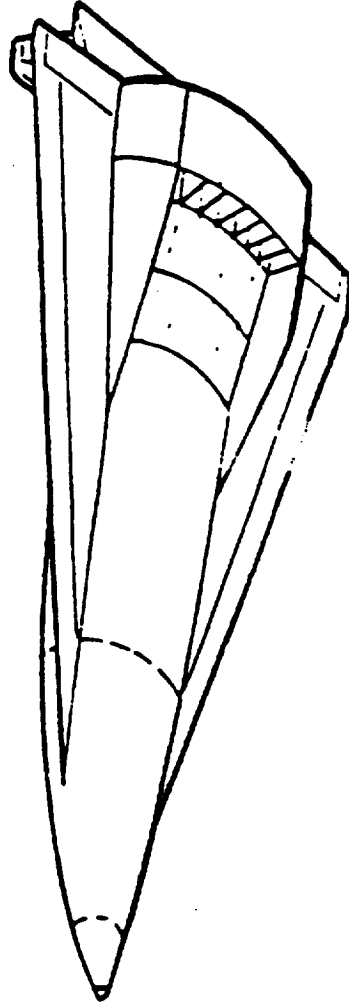

Form: Non-Axisymmetric

Placing the Study Vehicle in Context

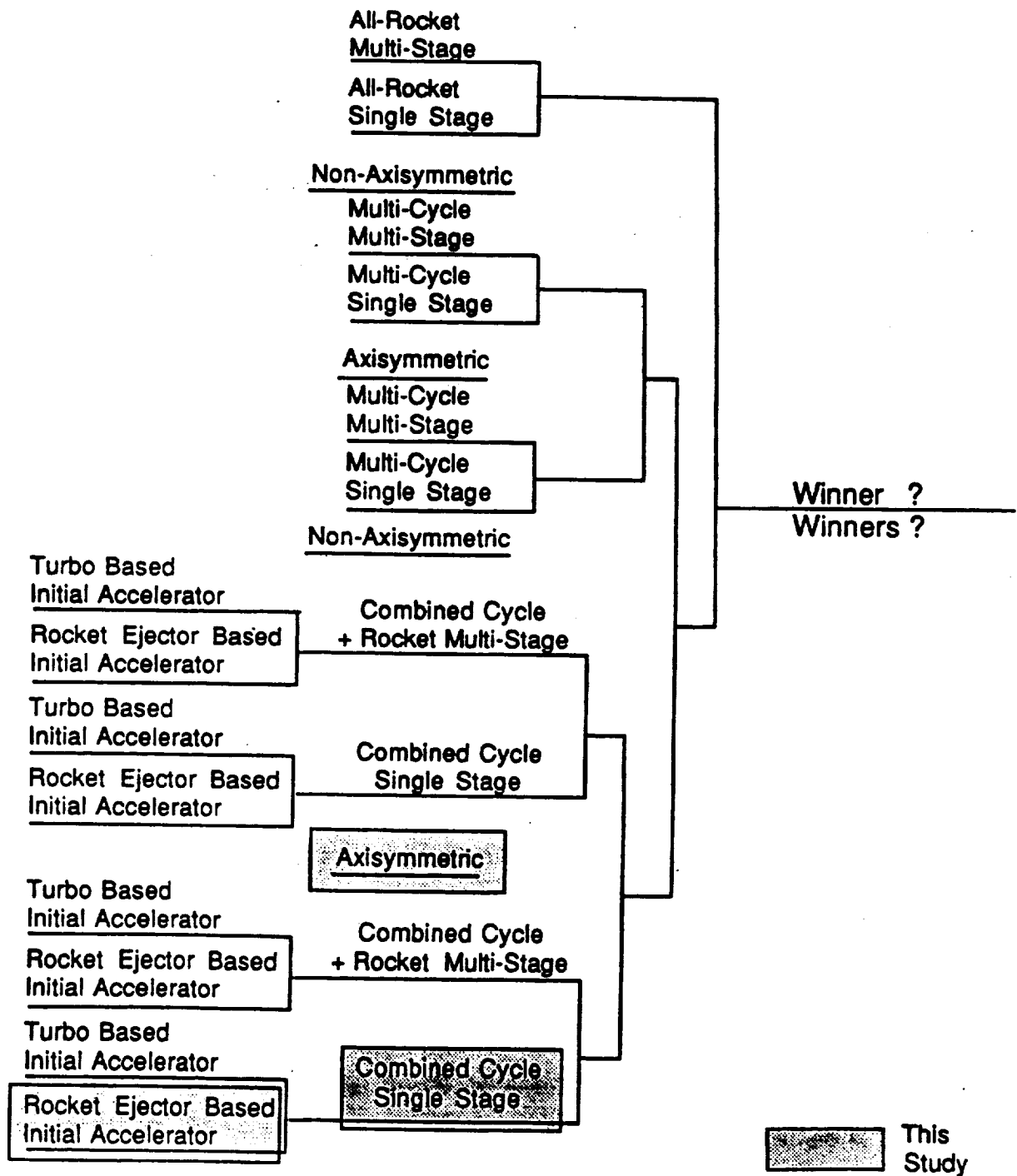

PAYLOAD COMPARISONS

The estimated payload delivery capability of the RBCC/SSSTO VTOHL vehicle systems studied is shown in comparison to all-rocket multi-stage alternatives in the facing figure.

Multistage All-Rocket & Extensively Axisymmetric RBCC SSTO GLOW's & Payloads

Engine #10 - Ejector Scramjet - 25% Strakes - VTO -1995 TAD
 Rocket Transition at Mach 15
 Liquid Hydrogen

100 nmi Orbit from the Eastern Test Range at a
 Nominal 30° Orbital Inclination

Vehicle	TOGW lbm	Payload lbm	Payload/TOGW percent
Saturn V	6,000,000	330,000	5.5
Shuttle	4,160,000	45,000	1.1
Titan 34D	1,500,000	27,600	1.8
Titan 4	1,500,000	40,000	2.6
ESJ/1500	1,500,000	190,000	12.6
ESJ/1000	1,000,000	100,000	10.0
ESJ/500	500,000	30,000	6.0

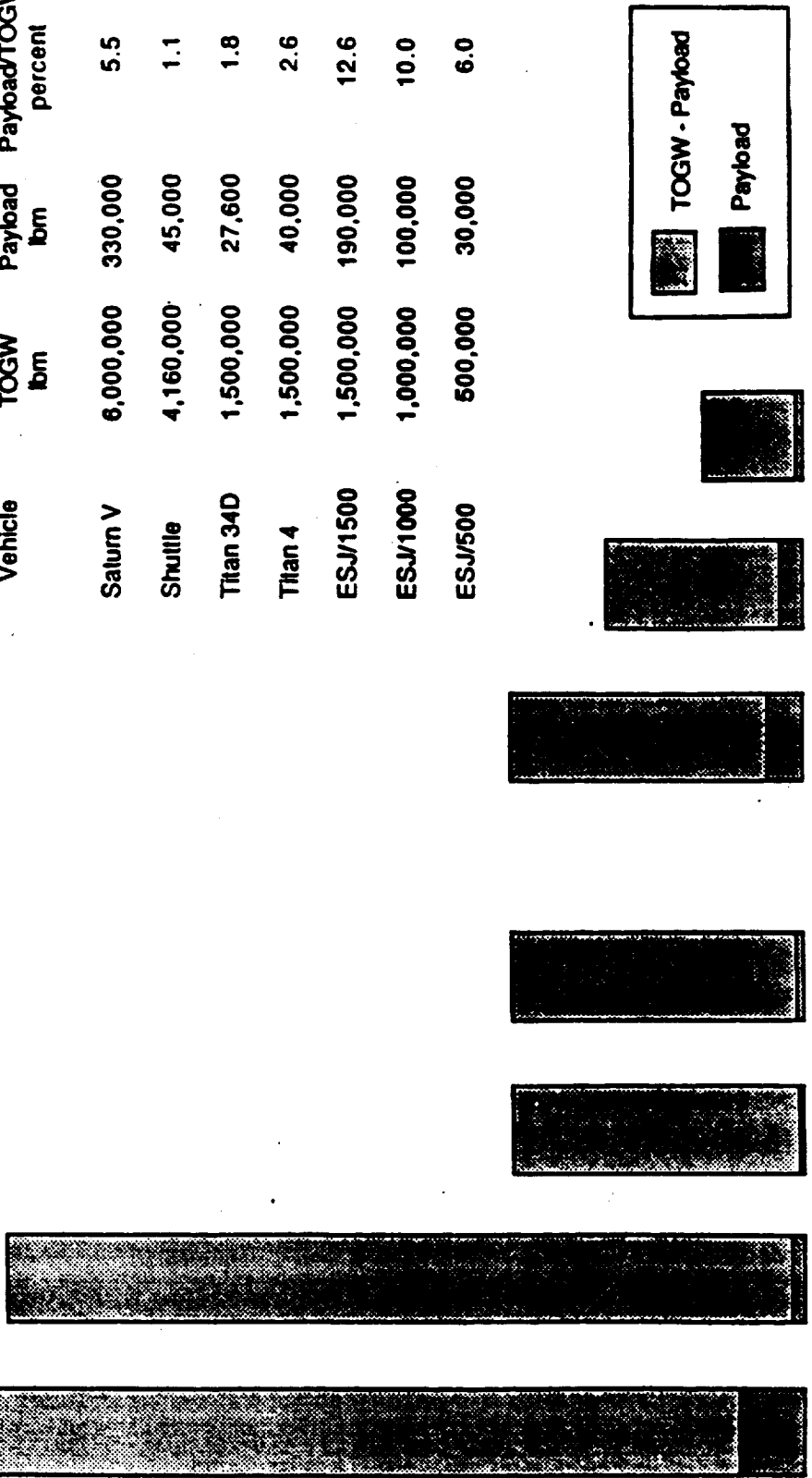

PAYLOAD AS A PERCENT OF DRY WEIGHT - A SYSTEM HARDWARE COST INDICATOR

In terms of payload as a percent of dry weight, the RBCC/SSSTO/VTOHL design approach outperforms the current all-rocket two-stage systems typified by the MSFC March 1987 study findings for the Fully Reuseable Winged Booster (FRWB) and Fully Reuseable Manned Orbiter (FRMO) two-stage combination.

This payload/inert weight ratio is due to high effective specific impulse of airbreathing engines, in the range from 650 to 700 seconds, combined with a "rocket-like" extensively axisymmetric structural design, which yields propellant mass fractions comparable to those achieved in rocket based systems.

Recent Study Findings - Payload/Dry Weight for RBCC SSTO and Fully Recoverable Winged Booster/Fully Recoverable Manned Orbiter

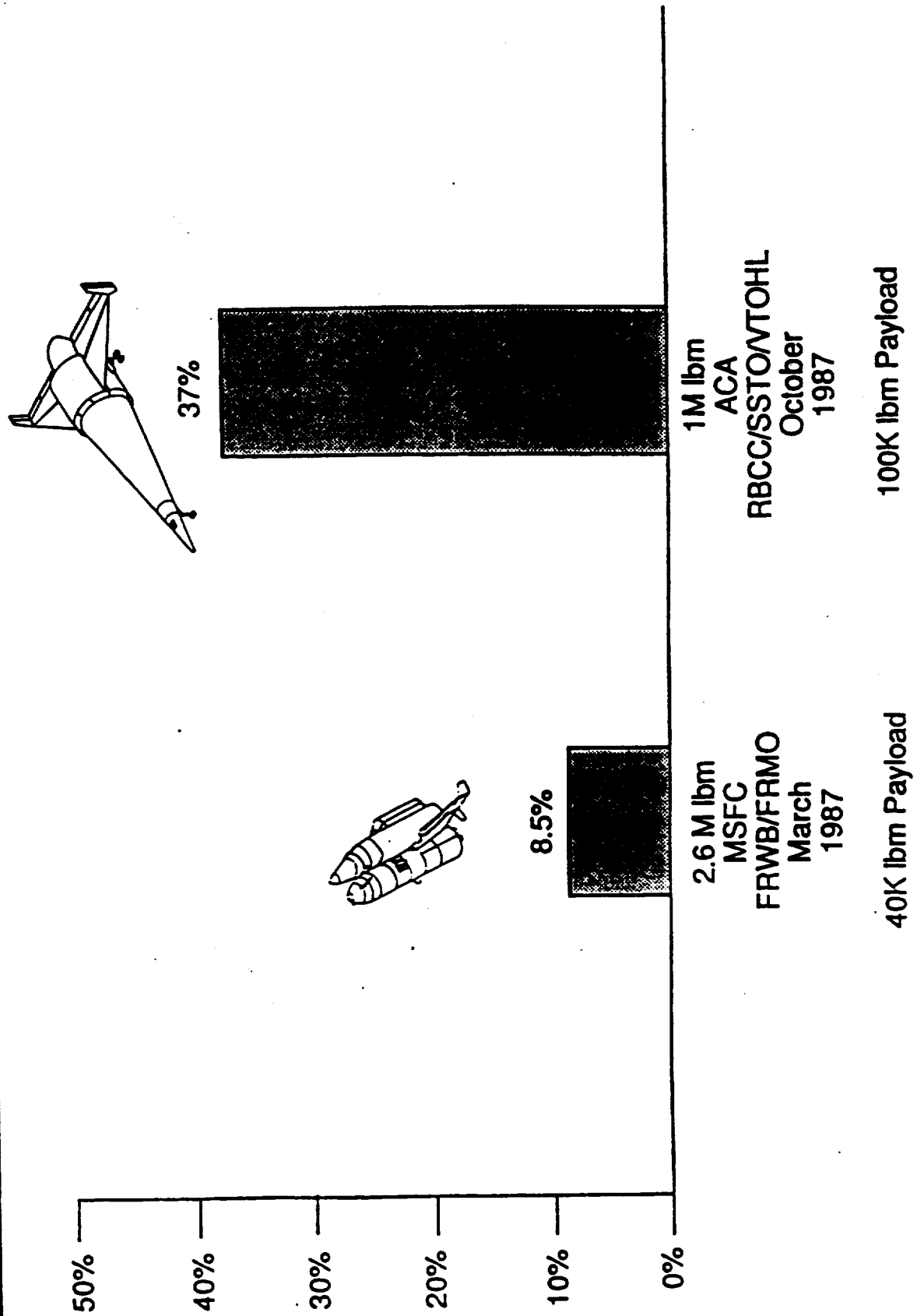

LIFE CYCLE COST (LCC) ESTIMATIONS - GROUND RULES

A life cycle cost estimation for an RBCC/SSSTO/VTOHL vehicle system was developed by Martin Marietta Denver Aerospace (MMDA) using MMDA's STAS cost model. This chart presents the assumptions under which that LCC analysis was carried out.

LIFE CYCLE COST (LCC) ESTIMATION

LCC Groundrules and Assumptions

- Fiscal Year 1987 Dollars
- Point Design Vehicle - 440 klb TOGW
- Structures and Engines Life = 100 flights
- Engines: Recycled Supercharged ScramLACE (#32)
- Stage-Up reliability = 0.996
- Stage-Down reliability = 0.996
- Mission Success = 0.992
- IOC = 2005
- 1997 - 2002 DDT&E
- 5 test vehicle in DDT&E phase
- 2 main operating bases (WTR & ETR)
- Cost of LH₂ = \$2.00/lb
- Cost of LOX = \$0.05/lb
- Cost of SLH₂ = \$4.00/lb
- Normal turnaround time for ground operations processing = 5 days (1 shift/day)
- Launch site facilities: Vehicle Service Facility
Operations Control Center
Propellant Servicing Area
- Payload encapsulation performed off-line (i.e., not in the vehicle-turnaround timeline).
- No pad or landing strip built (assume use of existing runways or pads).
- STAS Mission Model Civil Option II/DOD Option 2
- Vehicle capability 40klb LEO @ 28.5° - 100% manifest load factor.
- DDT & E Engines = \$2B , 1st Unit Cost = \$81M
- Payload lost cost is a function of flight rate, payload capability, reliability, and payload \$/lb.

OPERATIONS AND SUPPORT COSTS ESTIMATION - SSTO Operations

The findings of the AFAL study indicate an Operations and Support cost of \$160/Lb of payload delivered to the 100 nmi orbit.

**LIFE CYCLE COST (LCC) COMPARISON
BASELINE - OPERATIONS AND SUPPORT COSTS**

Operations \$ / LB Payload Comparison: 28.5° Inclined 100 n.mi

VEHICLE

O & S BASED SPECIFIC COST

SPACE SHUTTLE

\$2646 / LB - PAYLOAD

POINT DESIGN (THIS STUDY):

440 lbm TOGW

10,000 lbm Payload

\$160 / LB - PAYLOAD



CAPABILITY - UTILITY

The previously described superiority of the RBCC/SSTO/VTOHL design approach in terms of both payload fraction and payload to dry weight is available in a system with many additional characteristics and capabilities that yield a vehicle configuration that should have a high utility value - it should be useful in a diversity of missions in addition to the SSTO mission.

The range of atmospheric missions that could be performed by a vehicle of this design should be explored.

The range of low earth orbit and higher orbit missions with and without full or partial orbital refueling should be investigated.

No quantitative comparison of the advantages of extensively axisymmetric design over non-axisymmetric design in terms of aerodynamic design superiority, structural design superiority or lower life cycle costs has been carried out to date. This must be done before the advantages and disadvantages of the two alternatives can be compared in any meaningful way. Somehow these comparisons must be brought to some form of common baseline.

CAPABILITY - UTILITY

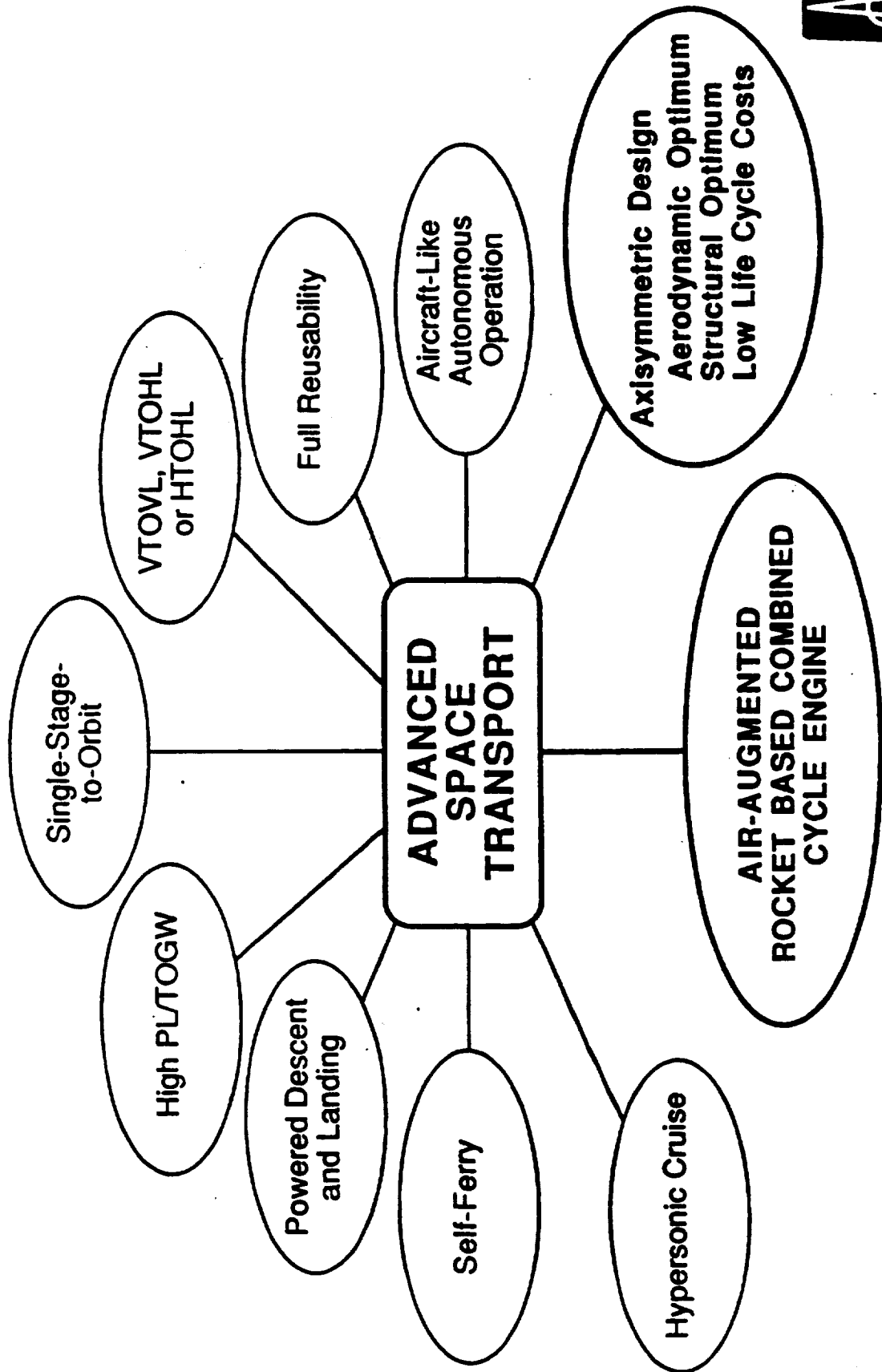

MULTIMODE PERFORMANCE OVER THE MISSION PROFILE

The RBCC design approach provides an integrated engine that is capable of starting from zero forward velocity using an air augmented rocket system, transitioning to ramjet, transitioning the scramjet and finally transitioning to rocket mode operating to Mach 25 in a single flow passage.

One variation of the RBCC propulsion system design incorporates a fan subsystem that serves to supercharge the air augmented rocket and ramjet modes. More importantly, the fan subsystem provides very high Isp values which enable multiple "go-around" capability and a significant atmospheric cruise capability. The Fan subsystem, with plenum burning, can provide vertical landing capability. The value of this capability in relation to the weight penalty must be determined by the user.

MULTIMODE PERFORMANCE OVER THE MISSION PROFILE

EXAMPLE: SUPERCHARGED EJECTOR SCRAMJET (ENGINE #12)

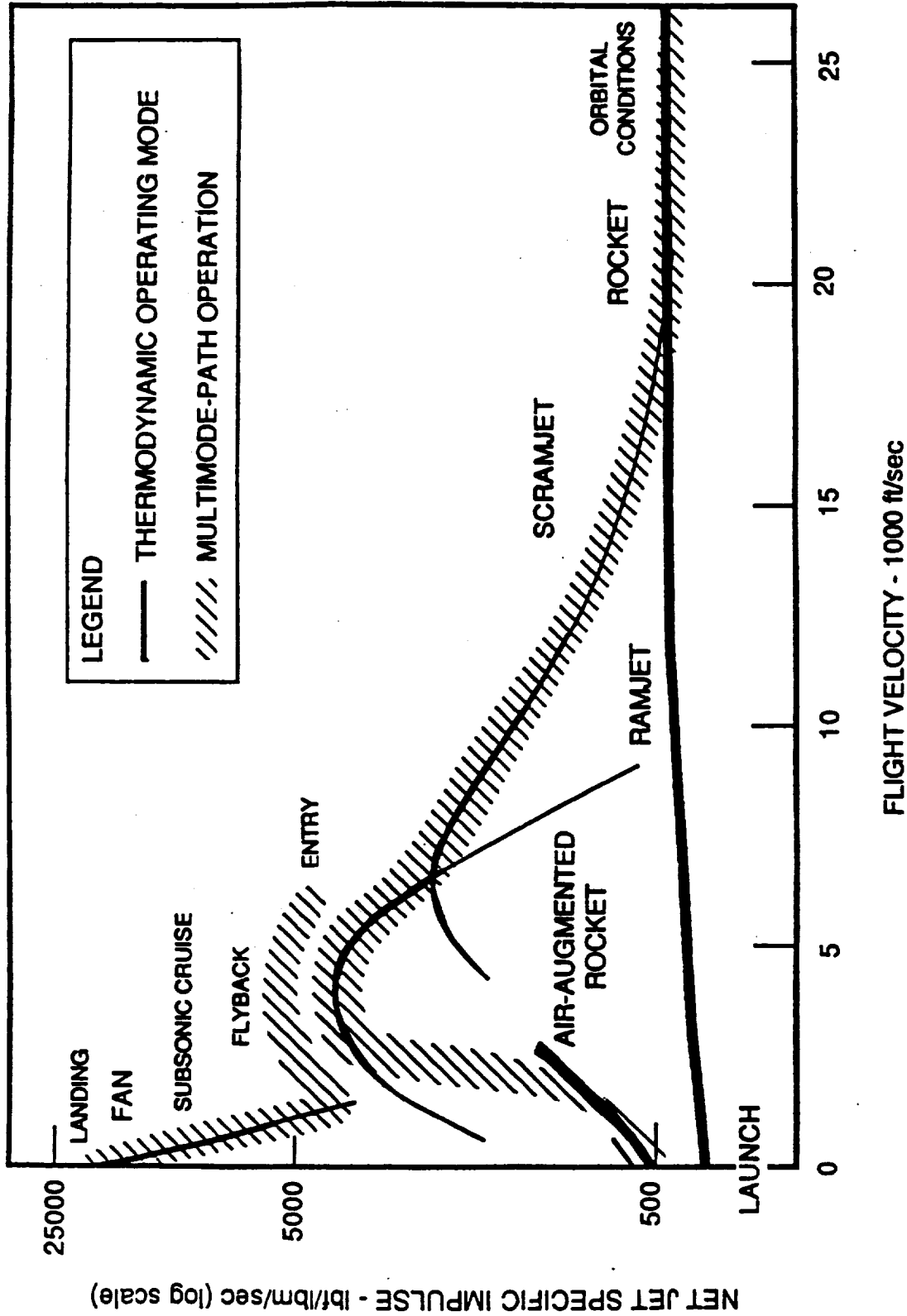

SELECTED ENGINE TYPE

There are over 31 variations of design approach to RBCC engine systems - it is a "family" of engines. The original investigations of these variations was carried out in the 1960's.

Five variants of the "family" met the requirements for SSTO propulsion. These were:

- o Engine #10 - Ejector Scramjet
- o Engine #12 - Supercharged Ejector Scramjet
- o Engine #20 - Ejector ScramLACE (with on-board air liquefaction)
- o Engine #22 - Supercharged Ejector ScramLACE
- o Engine #32 - Supercharged Ejector ScramLACE using slush hydrogen for LACE

The increasing engine numbers are indicative of increasing engine complexity; higher installed engine weight and lower thrust to weight ratio. The engine increased complexity and weight provides significant increases in Air Augmented Rocket mode specific impulse.

SELECTED RBCC ENGINE TYPES INVESTIGATED

5 - Variants Evaluated

Advanced LACE-Based Propulsion

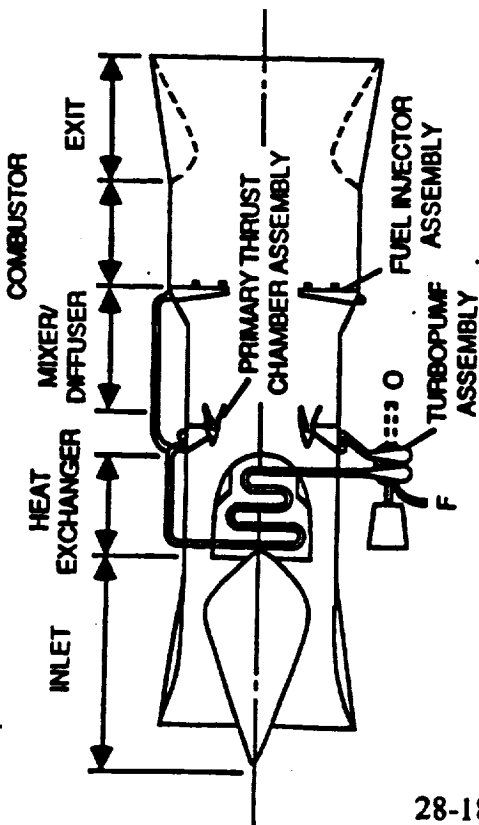

ScramLACE

Advanced Non-LACE

Comparison Propulsion Systems

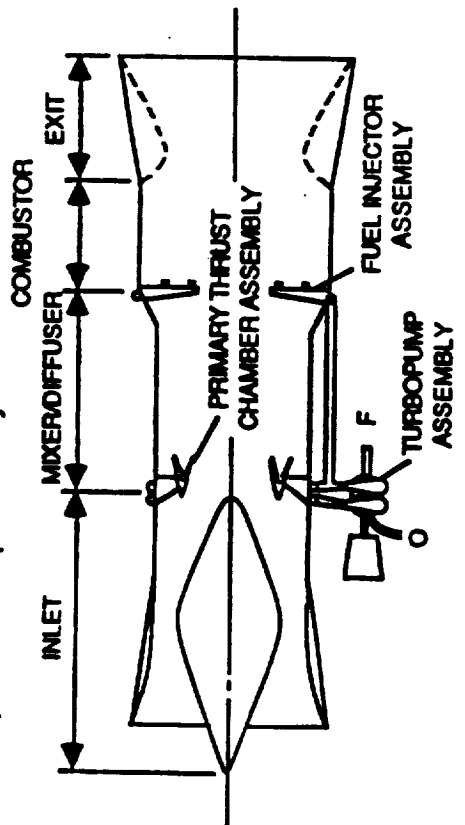

Ejector Scramjet

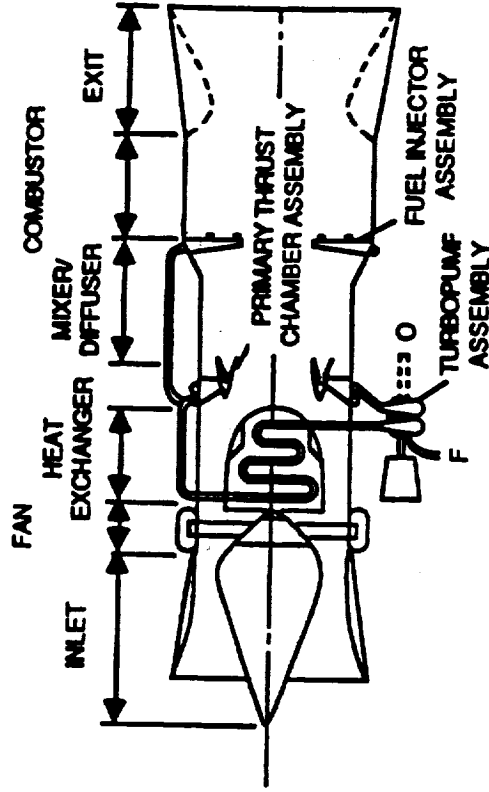

Supercharged ScramLACE
(Both Recycled and Non-Recycled)

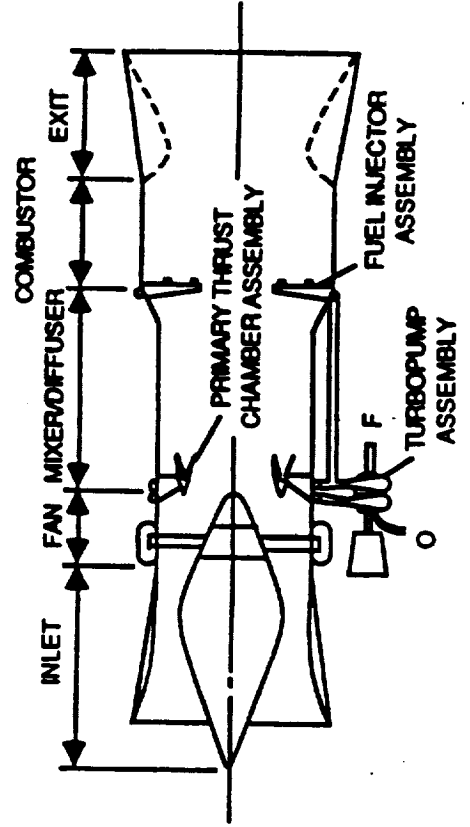

Supercharged Ejector Scramjet



SPECIFIC IMPULSE OVER THE ASCENT PROFILE BY ENGINE AND OPERATING MODE

All five engine types operate with the same ramjet, scramjet and final rocket mode in the SSTO mission. The difference between each of the five types is found only in the air augmented rocket ejector mode used at the start of flight from Mach 0 to Mach 3.5.

The superiority of the more complex engines using liquid air is clearly apparent in the air augmented rocket mode. However, we must consider the performance of each of these engine types over the full SSTO trajectory. We will present ACA's findings on full SSTO trajectory performance in the pages that follow.

SPECIFIC IMPULSE OVER THE ASCENT PROFILE BY ENGINE AND OPERATING MODE.

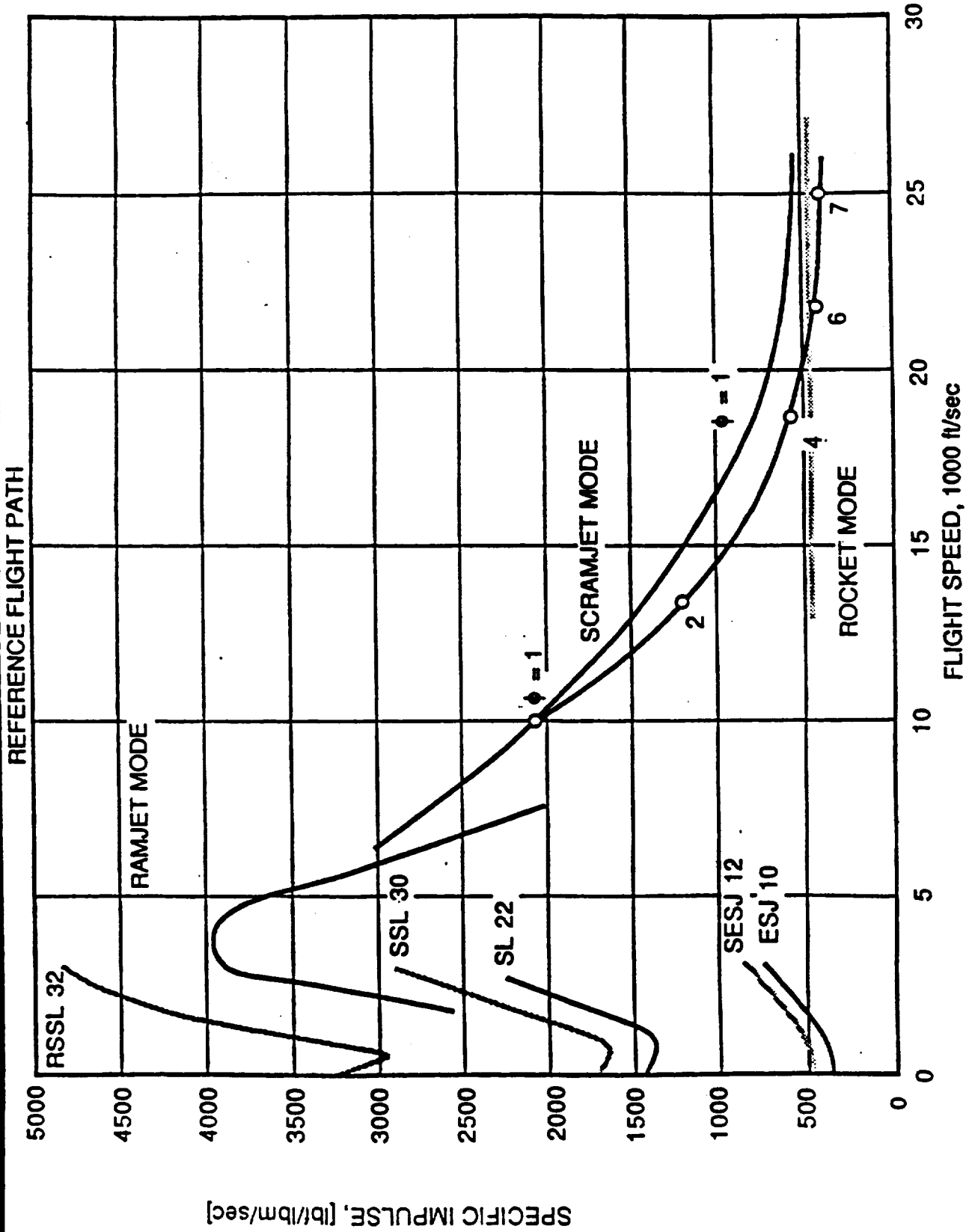

0334

ROCKET ENGINE SPECIFIC IMPULSE CALCULATION

We need to go back to the basics very briefly.

The final velocity of any rocket system is directly proportional to the specific impulse in vacuum.

Rocket thrust chamber specific impulse is calculated by dividing the thrust produced by the engine in lbf by the mass flow rate of oxidizer and fuel to the thrust chamber in lbf/sec. Overall engine specific impulse divides that same thrust by the mass flow rate of oxidizer and fuel to all propellant driven accessories needed to operate the engine plus the mass flow rate to the thrust chamber.

Neither rocket thrust chamber or rocket engine specific impulse include ram or profile drag, skin drag or base drag which must be separately determined together with gt losses, gravity vector value along the flight path x time, to determine the "effective" specific impulse for the rocket engine system operating in a vehicle flying a given trajectory in the atmosphere.

ROCKET ENGINE SPECIFIC IMPULSE CALCULATION

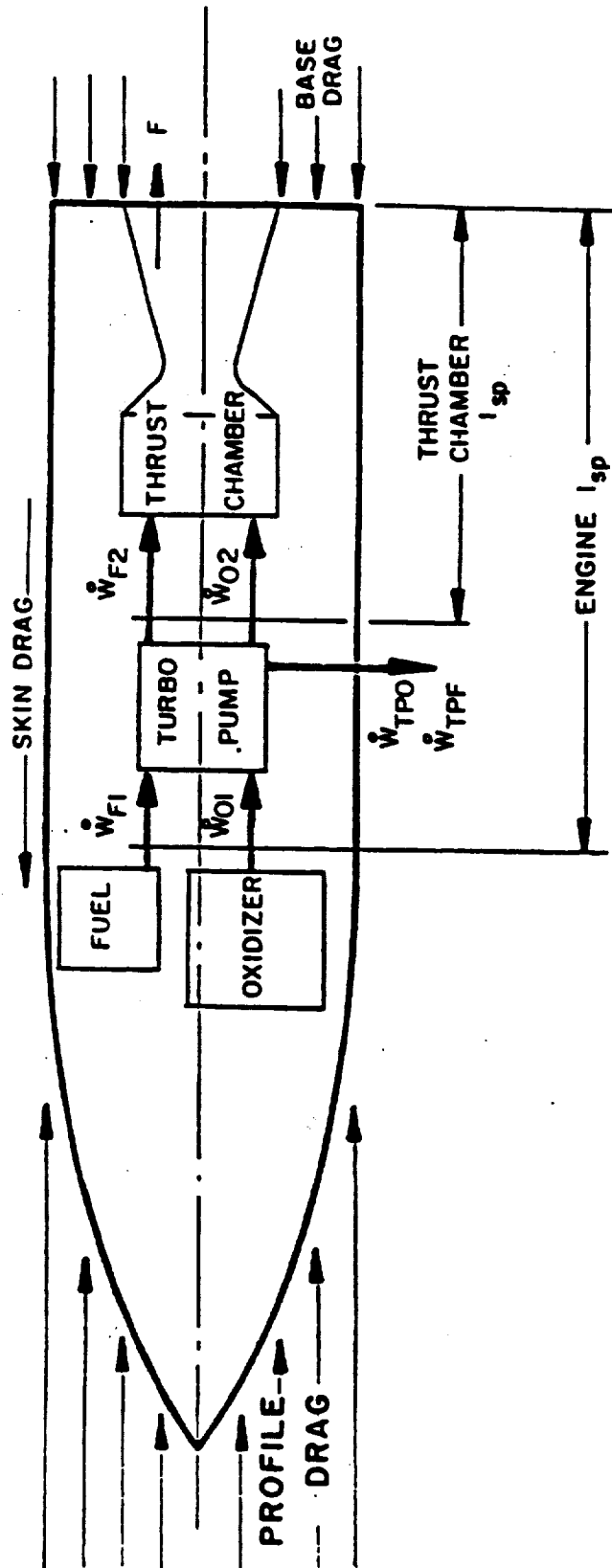

AIR-BREATHING ENGINES NET JET SPECIFIC IMPULSE CALCULATIONS

In air breathing engines in aircraft applications, the first significant difference in Specific Impulse calculation in comparison to the rocket case is that no oxidizer weight is involved.

The second significant difference is that the ram drag of the engine inlet is subtracted from the gross engine thrust as it would be measured in the rocket case. Thus the thrust value used is the "net" value of gross engine thrust minus inlet drag force. "Net Jet Thrust" of airbreathing engines is specific to flight altitude and velocity; it is not a constant value as in the rocket case.

The remaining vehicle ram drag, skin drag, base drag and gravity losses must be determined for the specific trajectory flown by the vehicle.

AIR-BREATHING ENGINES NET JET SPECIFIC IMPULSE CALCULATION

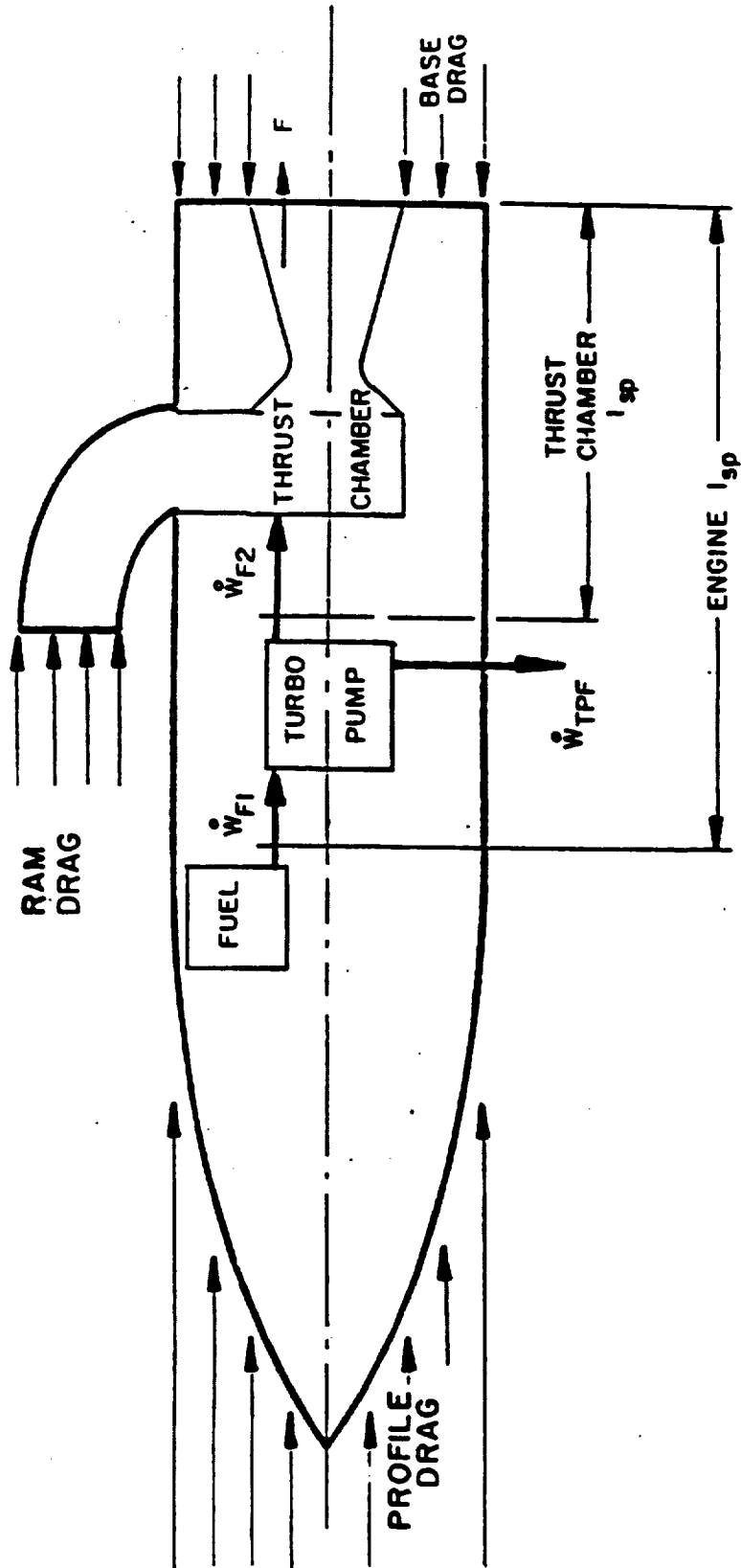

NET JET SPECIFIC IMPULSE OVER AN SSTO TRAJECTORY FOR AN EJECTOR SCRAMJET RBCC ENGINE

The far right column presents the net jet thrust based specific impulse of an Ejector Scramjet engine. Thus these values are gross thrust minus inlet ram drag incurred at the flight velocity and altitude conditions presented in the far left columns and are corrected for precompression on the vehicle forebody at these same altitude and velocity conditions using a 6 degree wedge to approximate an 8 degree cone forebody used in ACA's study.

These values are based on both theoretical calculation and experimental verification up to Mach 6. The scramjet values used have been reviewed by a number of persons working in this field in a variety of agencies and have been described as being "reasonable to slightly conservative". The rocket mode Isp values are not net jet but are computed on the rocket basis discussed in the second previous chart based on high altitude expansion of demonstrated hydrogen/oxygen rocket engine systems.

NET JET SPECIFIC IMPULSE OVER AN SSTO TRAJECTORY FOR AN EJECTOR SCRAMJET RBCC ENGINE

ENGINE 10 SPECIFIC IMPULSE PROFILE FOR REFERENCE TRAJECTORY
(FOR A 250 KIBF SLS ENGINE)
DAVID L. DOWRTY

15 JUNE 67

REFERENCE TRAJECTORY		SPECIFIC IMPULSE, I _{sp} (lbf-s/lbm) **						ENGINE
MACH NUMBER	ALTITUDE (ft)	EJECTOR	NO PRESS FIELD	4 DEG WEDGE	6 DEG WEDGE	8 DEG WEDGE	REFERENCE I _{sp} FT PROFILE	OPERATING MODE
(--)	(ft)	RAMJET	RAMJET	RAMJET	RAMJET	SCRAMJET		
0.0	0	430					430	EJECTOR
0.5	1000	430					430	
1.0	3000	470					470	
1.5	16000	545	2600				545	
2.0	30000	640	3350				640	
2.5	41500	715	3740				715	
2.9	48300	771	3880				771	
3.0	50000		3920	3700	3630		3700	RAMJET
3.3	57500		3930	3825	3765	3705	3765	
4.0	67000		3800	3730	3685	3640	3685	
4.5	68000		3610	3570	3535	3500	3535	
5.0	72500		3380	3370	3350	3330	3350	
5.5	76500		3100	3125	3125	3125	3125	
6.0	80000		2790	2900	2900	2900	2900	SCRAMJET
6.5	83500					3000	3000	
7.0	86500					2900	2900	
7.5	89500					2825	2825	
8.0	92000					2500	2500	
8.5	95000					2400	2400	
9.0	97500					2300	2300	
9.5	100000					2175	2175	
10.0	102000					2050	2050	
11.0	115000					1725	1725	
12.0	120000					1450	1450	
13.0	130000					1225	1225	
14.0	135000					1025	1025	
15.0	140000					850	850	
16.0	145000					750	750	
17.0	150000					650	650	
18.0	160000					550	550	
19.0	165000					525	525	
20.0	175000					475	470	ROCKET
21.0						450	470	
22.0						425	470	
23.0						400	470	
24.0						400	470	
25.0						400	470	
26.0						375	470	
27.0						375	470	

* AIAA-86-1388
 * STARS DATABASE 00211, CAPTURE AREA/CAPTURE AREA 0 M-25
 * 37.0 FT DIAMETER VEHICLE, 700 CAPTURE AT M-25
 * STARS DATABASE 0 780, PRELIMINARY ENGINE INFORMATION ON FIVE COMBINED CYCLE ENGINES
 ** A STUDY OF COMPOSITE PROPELLION SYSTEMS FOR ADVANCED LAUNCH VEHICLE APPLICATIONS, VOLUME 6
 ** A STUDY OF COMPOSITE PROPELLION SYSTEMS FOR ADVANCED LAUNCH VEHICLE APPLICATIONS, VOLUME 4, PAGE 23
 ** ASSUMES 6-DEGREE 2-DIMENSIONAL WEDGE INDUCED PRESSURE FIELD, EJECTOR MODE SHIFT TO RAMJET MODE AT MACH 3,
 ** RAMJET MODE SHIFT TO SCRAMJET MODE AT MACH 6, SCRAMJET MODE SHIFT TO ROCKET MODE AT MACH 20



AXISYMMETRIC VEHICLE AT 100% CAPTURE

RBCC engines can be designed to power a vehicle in the configuration illustrated on the facing chart.

In this configuration, the only difference between the Net Jet Specific Impulse Values presented on the preceding page and those encountered in flight are losses due to skin drag over the engine circumferential area and gravity losses.

Ram drag losses, over 100% of the frontal area, are already included in the previous Net Jet Isp values presented on the previous chart. With the exhaust jet completely wetting the aftbody, there is no base drag loss.

This condition is an instantaneous condition that occurs at termination of scramjet propulsion and immediately before transition to rocket mode in the systems studied by ACA.

The aftbody cone need not be configured as shown. It may be terminated as indicated by the dotted line and the remaining flow volume will fill with recirculating exhaust gases to produce the same zero base drag condition.

The condition illustrated is, as noted, an instantaneous one. However, it is approached progressively over the full trajectory and the benefits of this configuration realized over the full trajectory are significant.

In the ACA study, a value of 70% capture was used at the "shock-on-lip" condition - not the ideal value of 100%. The 70% figure is based on past hardware performance of real inlet systems.

AXISYMMETRIC VEHICLE AT 100% CAPTURE

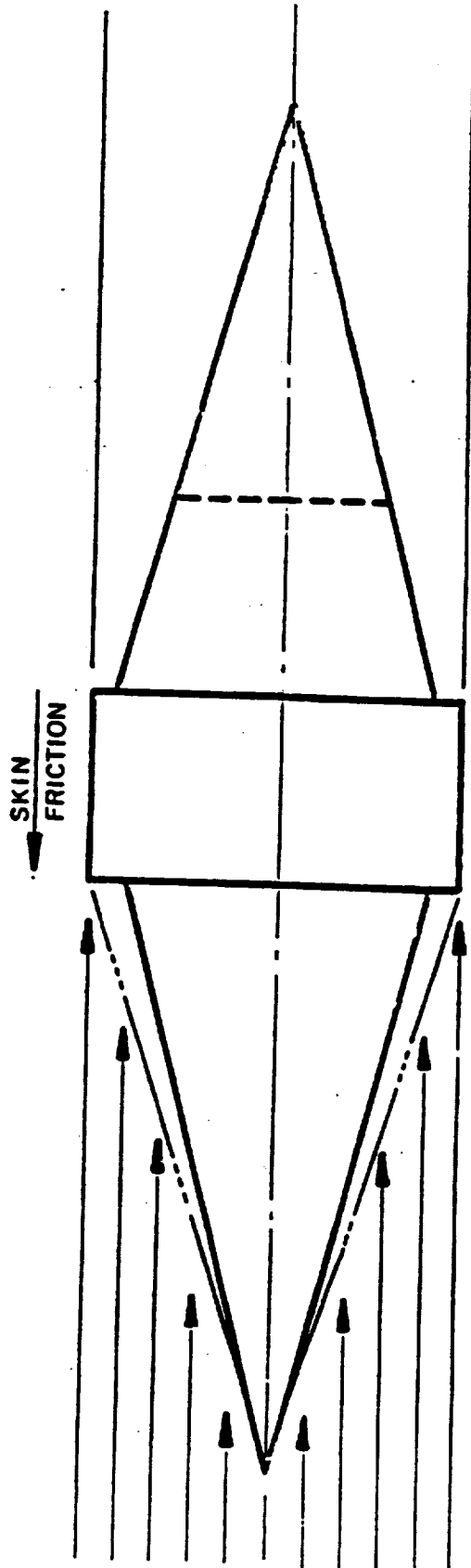

CAPTURE AREA FOR NON-AXISYMMETRIC AND AXISYMMETRIC VEHICLES

In otherwise directly comparable vehicles, non-axisymmetric configurations do not achieve the performance of axisymmetric configurations. Additional ram or profile drag losses are incurred.

Both configurations will incur all aerodynamic ram and skin drag and induced drag due to lift. Neither has an advantage or disadvantage in this respect.

A NOTE ON STRUCTURAL COMPLEXITY AND COST

Axisymmetric vehicle structures, i.e., structures constructed in a manner similar to ballistic rocket systems, have fewer and simpler unique structural elements and many identical structural elements.

Non-axisymmetric vehicles, i.e., aircraft like, have many unique structural elements. This is exemplified by the SHUTTLE structure which is composed of approximately 70% unique structural pieces for the upper left, lower left, upper right and lower right portions of its structure.

Axisymmetric vehicle design should be expected to provide significantly reduced design engineering costs, structural tooling costs and reduced structure parts count.

**CAPTURE AREA FOR NON-
AXISYMMETRIC AND AXISYMMETRIC VEHICLES**

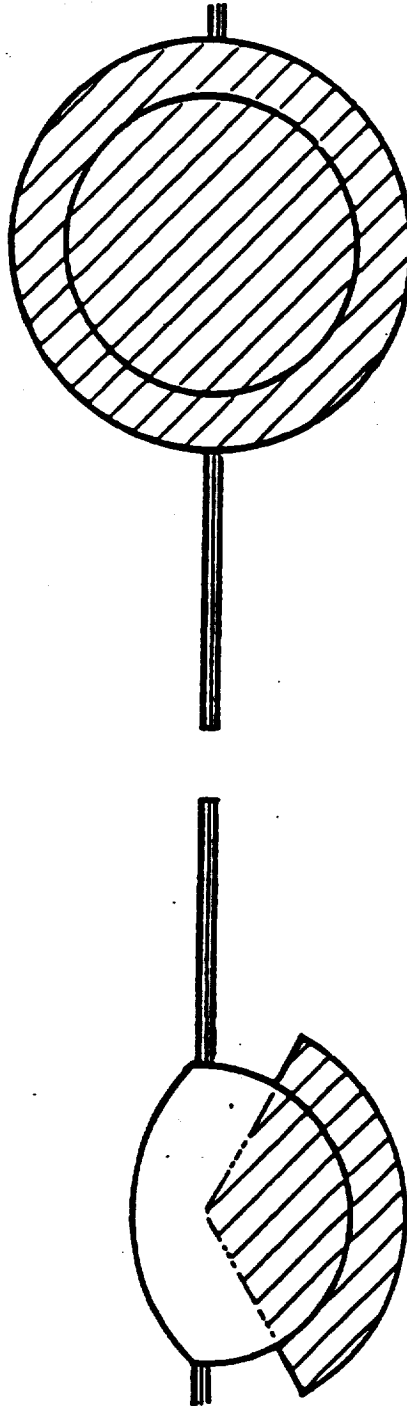

REFERENCE ASCENT FLIGHT PATH

The trajectories studied by ACA include both a constant q path at 1500 psf to local orbital velocity followed by a Hohmann transfer to 100 mile circular orbit and a 1500 psf constant q path to Mach 10 followed by an equilibrium radiation cooled wall temperature path to local orbital velocity and a Hohmann transfer to the 100 mile circular orbit.

The performance on the equilibrium path, in terms of payload delivered, was superior to the constant q path. However, other considerations such as limiting angle of attack on the forebody, might, with further study, be shown to be the optimum.

REFERENCE ASCENT FLIGHT PATH

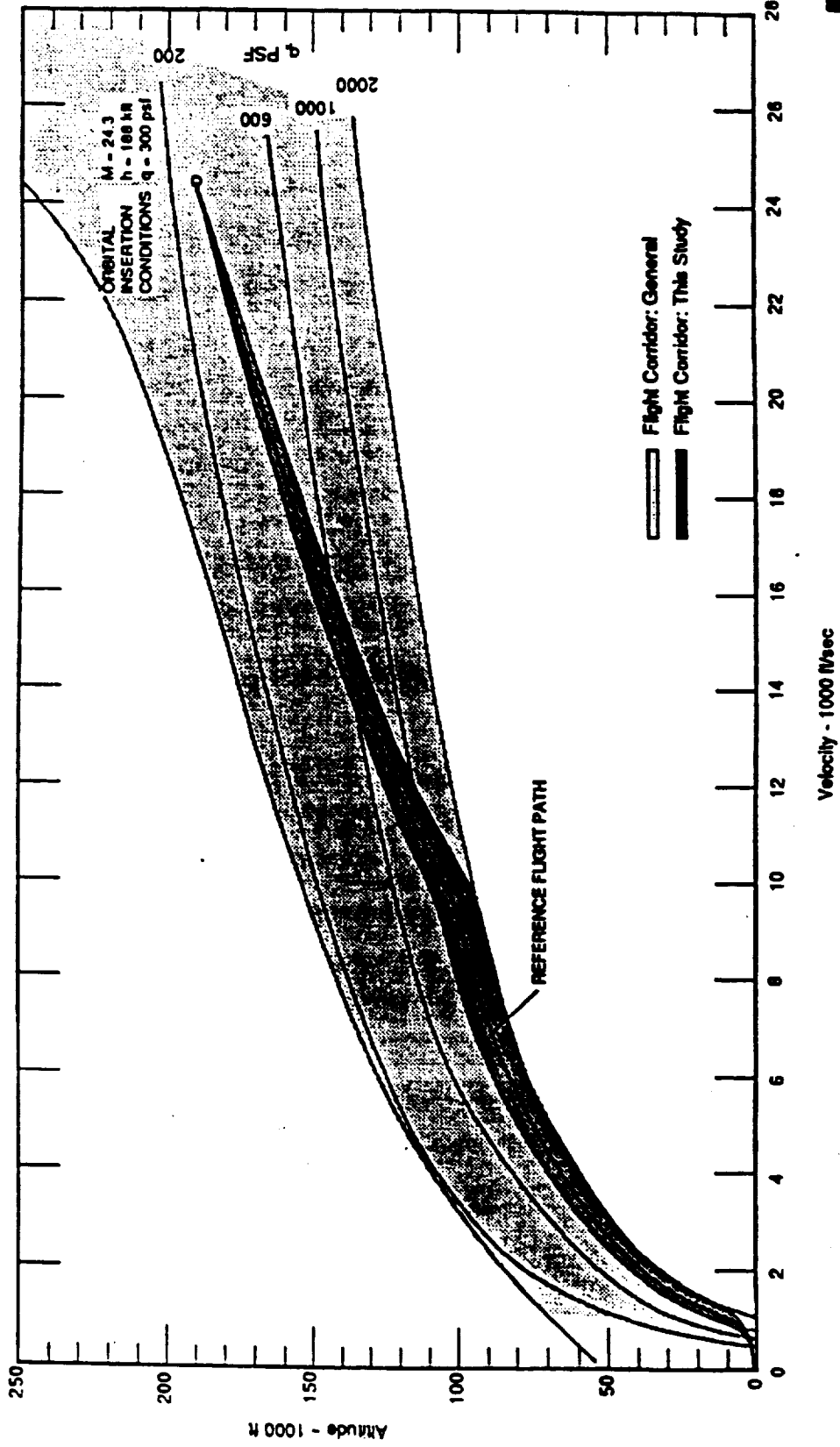

APPROACH TO TRAJECTORY SIMULATION USED

The objective of the six charts that follow is to show that the trajectory analysis work performed by ACA was extensive and detailed.

The trajectory analysis program used by ACA and MMDA was developed by AFWAL/POPA at WPAFB and is known as DOF36. DOF36 was used to analyze all five variations of the RBCC engines previously illustrated for orbital trajectories with aerodynamic characteristics and propulsion system characteristics defined an .5 Mach number intervals to Mach 10 and full mach number intervals to local orbital velocity. DOF36 provided finer analysis by interpolation between these values in the course of operation of the program.

Aerodynamic characteristics for the vehicle configuration studied were determined jointly by Martin Marietta Space Division and ACA staff. These characteristics were determined for all forms of drag, drag induced by lift and lift for the studied vehicle at angles of attack of +/- 18 degrees.

The engine performance tables used were developed for each of the five engines over the reference trajectory and an example for Engine 10 was presented in the preceding chart.

Well over 400 trajectory simulation runs were made in the course of study.

APPROACH TO TRAJECTORY SIMULATION USED

1. Select gross weight, engine and lifting surface size class
2. Estimate vehicle diameter over the engines
3. Select the appropriate Aero Table from 4 Strake Types
4. Select appropriate Engine Table from 5 engine types
5. Perform trial runs to achieve compliance to the Reference or other Trajectory Requirements in terms of Mach No. vs Altitude
6. When compliance is achieved, a run is made to establish the first calculated Mass to Orbit, M_2 , and the propellant mass requirements
7. Using an ACA program, Oxidizer and Hydrogen Volume requirements are calculated for each engine type
8. Using an MMDA program, the structural geometries and weight estimates are made
9. If the aerodynamic reference dimension, the diameter over the engines, produced by the MMDA program, which includes Hohmann transfer propellants, RCS propellant, Retrofire and Bolloff and Reserves, are more than 3% different from the initial estimate in 2. above, the simulation is rerun with the new diameter. Otherwise, the run is accepted
10. When the run is accepted as a valid trajectory simulation, the MMDA program generated weight estimate is also accepted.
11. The MMDA program generated weights and geometries include VEHICLE STRUCTURE WEIGHT, Hohmann transfer Propellants, RCS Propellant, Retrofire and Bolloff and Reserves. These weights are subtracted from M_2 determined in 9. above. This yields the mass available for flyback propellant and discretionary payload



TABULAR OUTPUT - REPORT 1

DOF36 provided a detailed tabular output of the performance of the vehicle over the full trajectory.

Gamma	Flight Path Angle
Alpha	Angle of Attack
W-Dot	Propellant Mass Flow Rate
Isp	Net Jet Isp
Ieff	Net Jet Isp minus drag and gt losses
Irat	Ratio of Isp/Ieff
GCB-1	Longitudinal Acceleration

TABULAR OUTPUT - REPORT 1

1 6 D - O - F S U M M A R Y O U T P U T
 0 ENGINE 32, REF HOR TRAJ/ISP/FFMAX, ACA AERO - 16 deg - 59.5 ft DIA - 10% STRAKE
 0 AERODYNAMIC FILE ----- A321016V.611
 0 ENGINE FILE ----- E32REFH.615
 0 INPUT FILE ----- I3210HP.623
 0 SUMMARY FILE ----- O3210HP.623

++++ RUN SUMMARY ++++
 ENGINE 32, REF HOR TRAJ/ISP/FFMAX, ACA AERO - 16 deg - 59.5 ft DIA - 10% STRAKE
 TERMINATION CONDITION = 101
 FINAL CONDITIONS:
 TIME = 1005.48 ALT = 107986.6 MACH = 24.31
 M1 = 956000.00 M2 = 353468.59 MR = 2.7046
 ISPE = 806.59 ISPA = 1271.17 ISPT = 0.7659200000E+09

1///// D - O - F OUTPUT SUMMARY /////

PAGE 1

TIME	ALTITUDE	MACH	SPEED	Q	GAMMA	ALPHA	WEIGHT	W-DOT	ISP	THRUST	IEFP	IRAT	GCB-1
0.00	0.0	0.00	1.0	0.00	0.00	0.00	956000.00	3100.00	3319.6	1311240.6	0.0	0.00	1.37
5.00	0.0	0.19	216.2	0.39	0.00	0.78	954051.56	383.04	3242.5	1242012.5	3278.1	1.01	1.30
10.00	0.0	0.37	416.1	1.43	0.00	8.82	952171.44	368.86	3170.9	1169629.9	3149.3	0.99	1.27
15.00	0.0	0.52	576.4	2.74	0.79	16.36	950348.00	392.46	3131.1	1228843.6	2599.5	0.83	1.30
20.00	311.4	0.62	694.8	3.95	11.19	16.02	948377.69	395.45	3203.7	1266910.6	1773.4	0.55	1.31
25.00	1445.4	0.70	776.3	4.77	24.48	13.53	946394.94	397.57	3255.3	1294213.7	1210.4	0.37	1.33
30.00	3491.7	0.77	852.8	5.42	35.02	9.58	944402.00	399.65	3305.9	1321211.5	1128.0	0.34	
35.00	6270.7	0.86	938.9	6.04	41.21	4.96	942397.75	402.08	3364.7	1352889.9	1260.1	0.37	
36.92	7499.6	0.90	973.1	6.24	42.31	3.17	941623.69	399.86	3388.7	1355000.4		0.37	
36.92	7499.6	0.90	973.1	6.24	42.31	3.17	941623.69	399.86	3388.7	1355000.4		0.37	
39.00	8882.9	0.93	1011.2	6.24	42.31	2.18	940785.3						
44.00	12281.8	1.03	1105.1	6.93	38.31	2.00							
49.00	15867.4	1.15	1202.7										
54.00	19911.0												



0611

DOF36 GRAPHICAL OUTPUT OF MAJOR PERFORMANCE PARAMETERS OVER THE REFERENCE TRAJECTORY - PLOT NO. 1

DOF36 was interfaced with a plotter to produce two graphical outputs of vehicle performance over the full trajectory. In the output presented here, the major vehicle performance measures are plotted.

I1025VP.500 - PERFORMANCE
 ENGINE 10, REF TRAJ, FULL CAPTURE @ M=15
 500K lbm VEHICLE - 47.3 ft DIA - 25% STRAKES

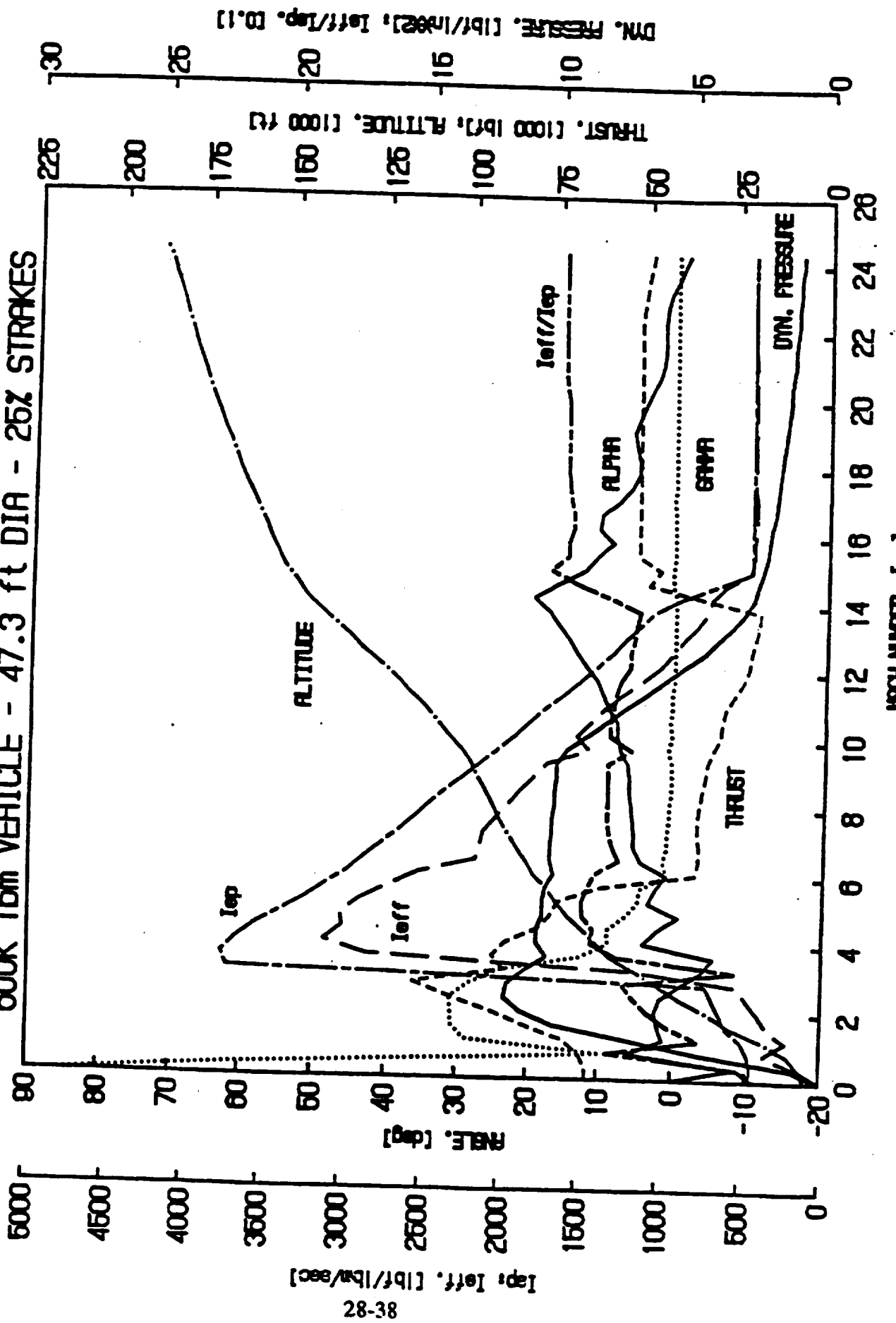

DOF35 GRAPHICAL OUTPUT OF MAJOR PERFORMANCE PARAMETERS OVER THE REFERENCE TRAJECTORY - PLOT NO.2

The second graphical output presented the weights and forces variation over the full trajectory. In the example illustrated here, transition from scramjet mode to rocket mode occurs at Mach 15. This transition point was found to be an optimum as will be discussed further. This optimization characteristic was a major finding of the ACA study.

I1025VP.500 - WEIGHTS & FORCES
 ENGINE 10, REF TRAJ, FULL CAPTURE @ M=15
 500K lbm VEHICLE - 47.3 ft DIA - 25% STRAKES

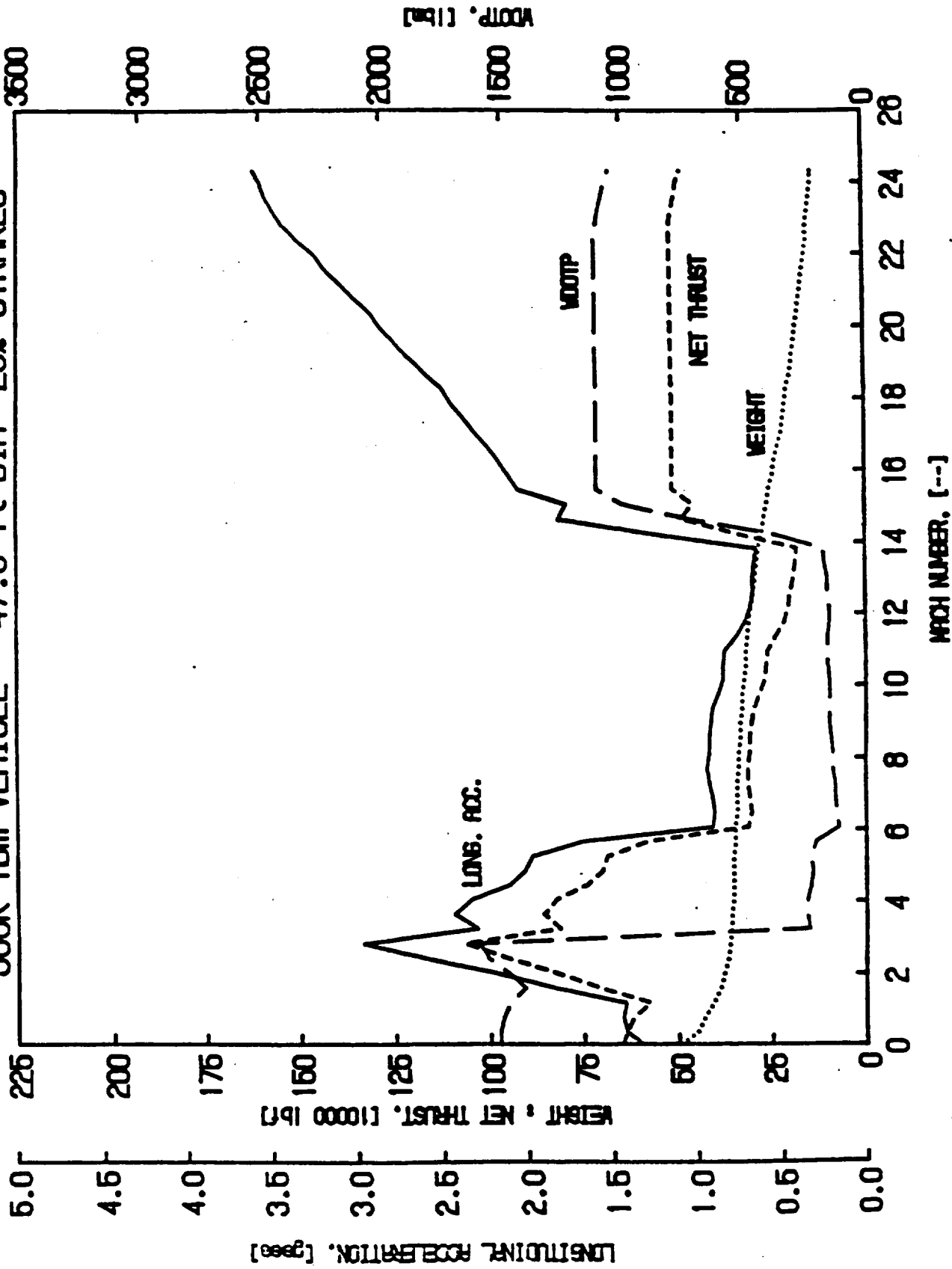

MMDA WEIGHT, SIZING AND C.G. ANALYSIS

Based on their in-house experience with launch vehicle structures, Titan IV and STAS related analyses, MMDA developed weight estimations for the structural elements

Propulsion system weight estimates were developed by ACA.

Both groups of weight estimation data assumed current technology and the reductions expected to be achieved by 1995 which was the development start date target for the study.

Vehicle Sizing Data for 1995

Vehicle Name: Strawman 1 Configuration :S105015V.500

Program Name: Air Augmented Rocket

Date: 12-03-1987

Nose Cone Data:

Length = 9.8'
Nose Cap Radius = 1'
Major Outside Diameter = 4.5'
Wetted Area = 98 sqft
Structure Weight = 179 lb
C.G. = Sta 67.4

Crew Compartment Data:

Length = 17.8'
Minor Outside Diameter = 4.5'
Major Outside Diameter = 9.5'
Wetted Area = 393 sqft
Structure Weight = 719 lb
C.G. = Sta 237.3

Fixed Weight = 3,000 lb
C.G. = Sta 190.5

Crew Weight = 440 lb
C.G. = Sta 292.9

Oxidizer Area Data:

Length = 30.2'
Minor Outside Diameter = 9.5'
Major Outside Diameter = 18.0'
Wetted Area = 1,316 sqft
Structure Weight = 2,408 lb C.G. = Sta 531.1

Tank Weight = 531 lb C.G. = Sta 596.5

Oxidizer Weight = 258,011 lb C.G. = Sta 604.1

Tank Insulation Weight = 1,602 lb C.G. = Sta 596.5

Small Dome Height = 3.5'
Small Dome Diameter (I.D.) = 10.0'
Tank Frustum Length = 21.0'
Large Dome Height = 5.6'
Large Dome Diameter (I.D.) = 15.9'

Tank Volume = 3,741 cuft

Fuel Area Data:

Length = 82.6'
Minor Outside Diameter = 18.0'
Major Outside Diameter = 33.6'
Surface Area = 6,842 sqft
Structure Weight = 12,521 lb
C.G. = Sta 1233.7
Tank Weight = 4,018 lb
C.G. = Sta 1175.1
Fuel Weight = 121,359 lb
C.G. = Sta 1199.2
Tank Insulation Weight = 8,183 lb
C.G. = Sta 1175.1
Small Dome Height = 6.9'
Small Dome Diameter (I.D.) = 19.4'
Tank Frustum Length = 48.7'
Large Dome Height = 16.5'
Large Dome Diameter (I.D.) = 33.1'
Tank Volume = 28,306 cuft

Payload Bay Area:

Length = 10'
Wetted Area = 648 sqft
Structural Weight = 1,186 lb
C.G. = Sta 0.0
Payload C. G. = Sta 1619.1

Engine Area Data:

Engine Type = 10
of Engines = 8
Total Engine Weight = 40,880 lb
C.G. = Sta 1275.4

Strake Area Data:

Strake Length = 58.5'
Surface Area (ea) = 568 sqft
Total Weight = 8,309 lb
C.G. = Sta 749.4

Misc. Component Data:

APU Weight = 5,000 lb C.G. = Sta 78.6
Landing Gear Weight = 10,000 lb C.G. = Sta 1395.6
Wiring Weight = 382 lb
RCS & Control Weight = 454 lb

Overall Vehicle Data:

Length = 140.4'
Tank Structure O.D. = 33.6'
Diameter to Outside of Strakes = 50.4'
Diameter to Outside of Engines = 42.6'
Max. Fuselage Diameter = 50.4'
Nose Cone Angle = 16.0 deg.
Tail Cone Angle = 20.0 deg.

Sizing based on Liquid Fuel

Propellant Weight & Volume Break Down

Fuel:

Ascent	115,505 lb	26,132 cuft
Hohman Transfer	329 lb	74 cuft
ACS	25 lb	6 cuft
Retrofire	351 lb	79 cuft
Boiloff & Resvs	149 lb	34 cuft
Flyback	5,000 lb	1,131 cuft
Total	121,359 lb	27,457 cuft

Oxidizer:

Ascent	252,928 lb	3,557 cuft
Hohman Transfer	1,917 lb	27 cuft
ACS	152 lb	2 cuft
Retrofire	2,122 lb	30 cuft
Boiloff & Resvs	891 lb	13 cuft
Total	258,011 lb	3,629 cuft

Ascent Fuel Weight Includes :

- 1½ Addition for Residuals and Unusable Fluids
- 1.5½ Addition of the Usable Fuel for the APU, RCS, and ECS

Vehicle Weight Summary:

Component Name	Component Weight (lb)
Fuselage & TPS	17,012 lb
Strakes	8,309 lb
Tanks (O2 & H2)	4,549 lb
Insulation	9,785 lb
Fixed	3,000 lb
RCS & Controls	454 lb
Wiring	382 lb
APU	5,000 lb
Engines & Inst	40,880 lb
Landing Gear	10,000 lb
Dry Weight	99,370 lb
Propellant	374,370 lb
Payload	
Net	20,820 lb
Flyback	5,000 lb
Crew	440 lb
Gross Veh. Weight	500,000 lb

Fuel Mass Fraction = 75.9 %
 Payload/Glow Ratio = 0.053
 Payload/Dry Weight Ratio = 0.264

Dry Weight C.G. = Sta 1064.7
 Gross Weight C.G. = Sta 882.1

SENSITIVITIES AND TRADES

- 1. Payload sensitivity to Takeoff Mode**
- 2. Payload sensitivity to l_{sp} variation by Propulsion Mode and Scramjet Termination Mach Number**
- 3. Payload sensitivity to Mach number and vehicle gross takeoff weight**
- 4. Payload sensitivity to engine type and vehicle gross weights at takeoff**
- 5. Payload sensitivity to inert weight estimates for various engine types and different gross weights at takeoff**
- 6. Payload sensitivity to the use of Slush Hydrogen**
- 7. Payload sensitivity to drag estimates**
- 8. Sensitivity of range and endurance to engine type and cruise Mach number.**



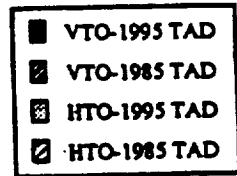
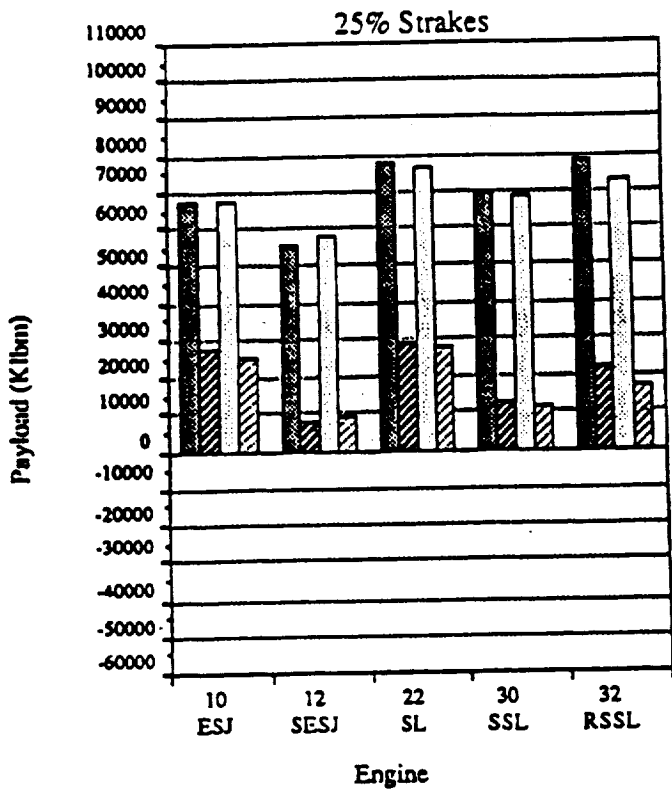

Mach 20 Scramjet/Rocket
Transition

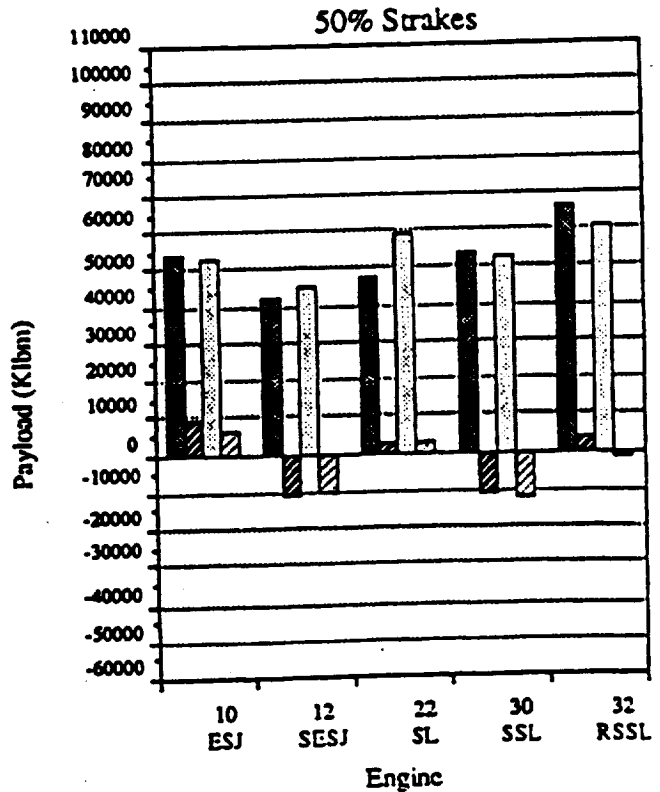
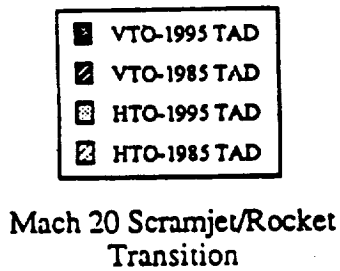

Payload vs. Engine Type and Strake Size for a 956 klbn Vehicle at 20%
and 25% Strake Sizes

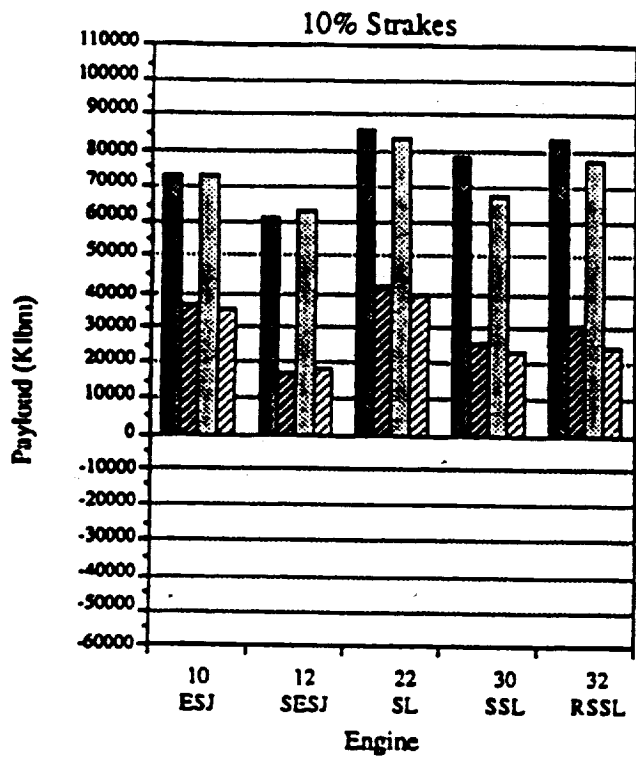

Mach 20 Scramjet/Rocket
Transition

Mach 20 Scramjet/Rocket
Transition

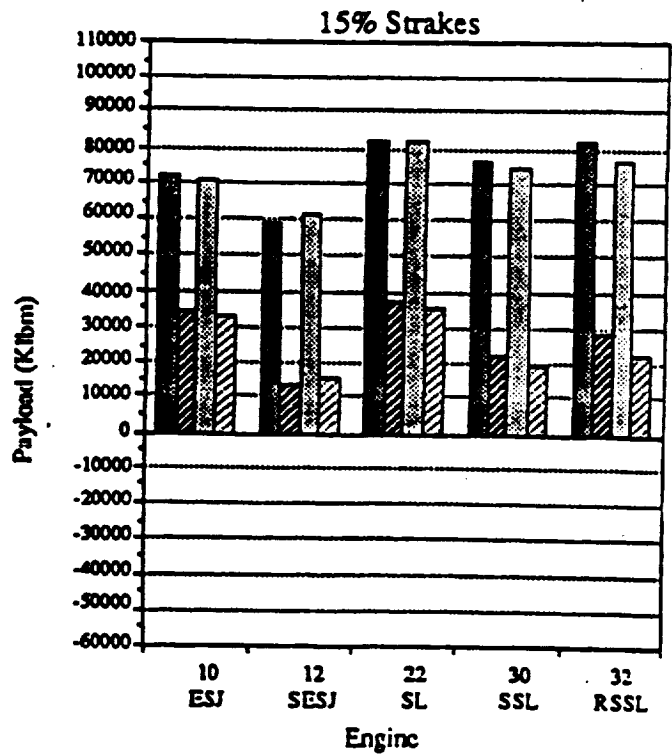

Payload vs. Engine Type and Strake Size for a 956 klbm Vehicle at 10%
and 15% Strake Sizes

1995 TAD PAYLOADS vs. FULL CAPTURE
& ROCKET OUT MACH NUMBER
#10 - 25% STRAKES - VTO

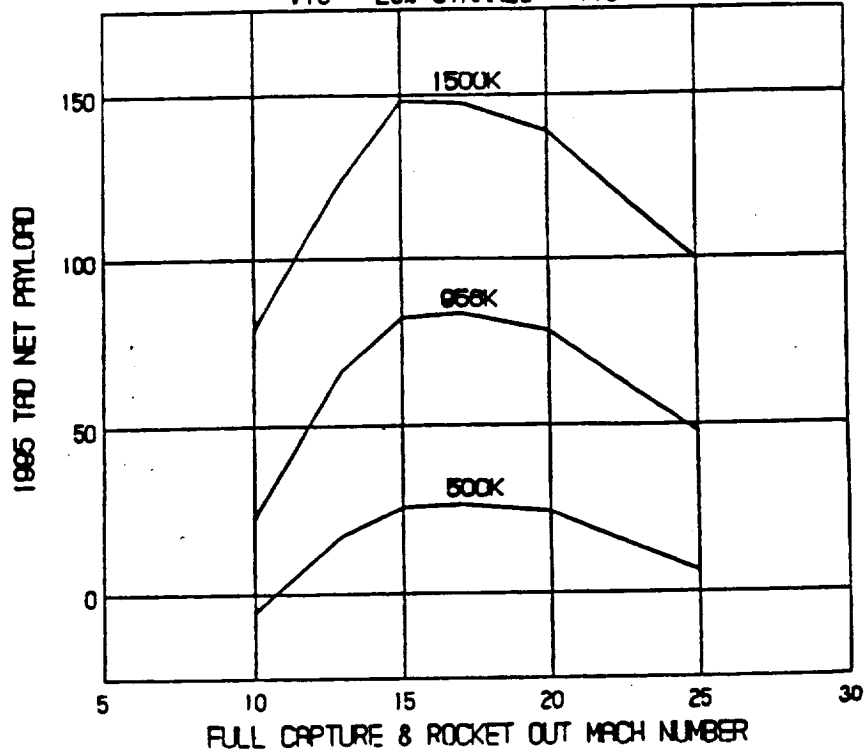

Payload vs. Full Capture and Rocket Out Mach Number for Varying TOGW/GLOW Weight Classes

1995 TAD PAYLOADS vs. FULL CAPTURE
& ROCKET OUT MACH NUMBER
956K VEHICLE - 25% STRAKES - VTO

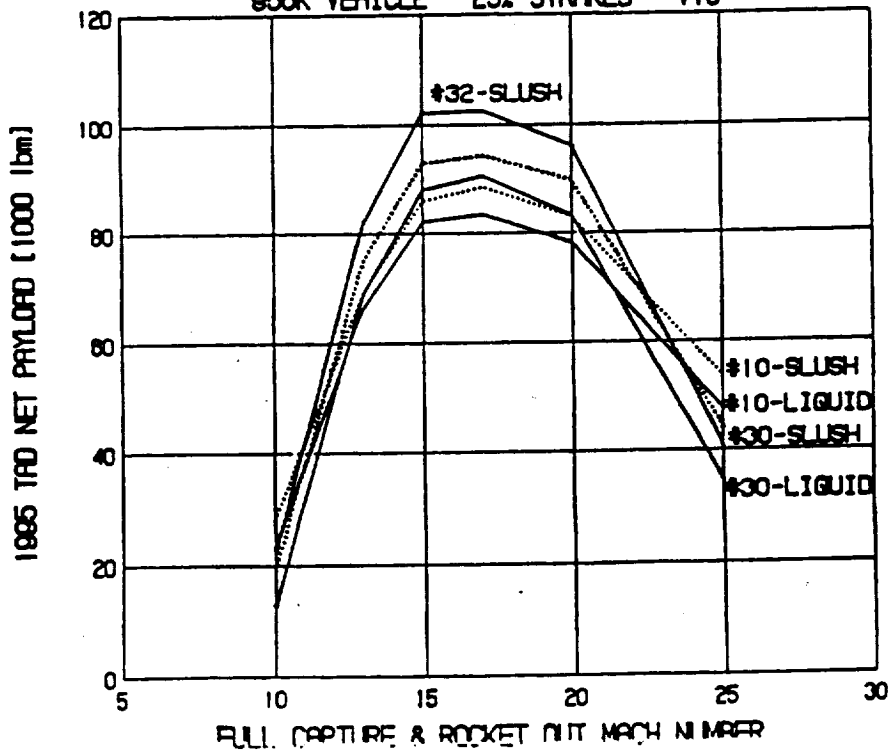

Payload vs. Full Capture and Rocket Out Mach Number for Various Engine Types

1995 TAD PAYLOADS vs. +/- 10% Isp BY OPERATING MODE
 956K VEHICLE - #32 - 50% STRAKES - VTOHL - FULL CAPTURE
 @ M=25 - AIRBREATHING TERMINATION @ M=20

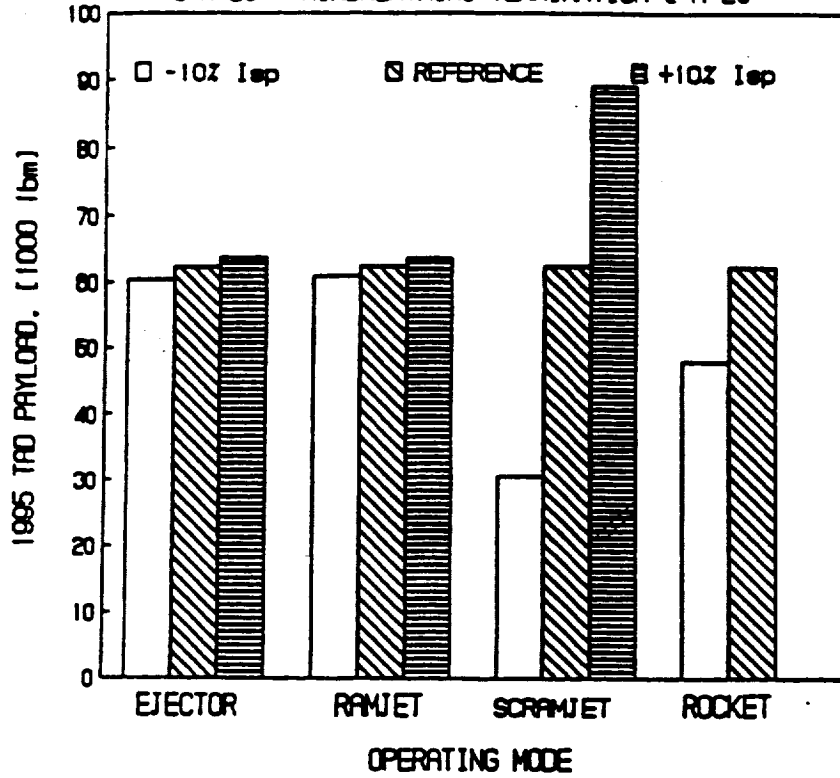

Effect of +/- 10% Isp by Propulsion Mode on Payload

VEHICLE WEIGHT vs. TIME
 956K VEHICLE - 25% STRAKES - VTO
 1995 TAD - FULL CAPTURE & ROCKET @ M=15

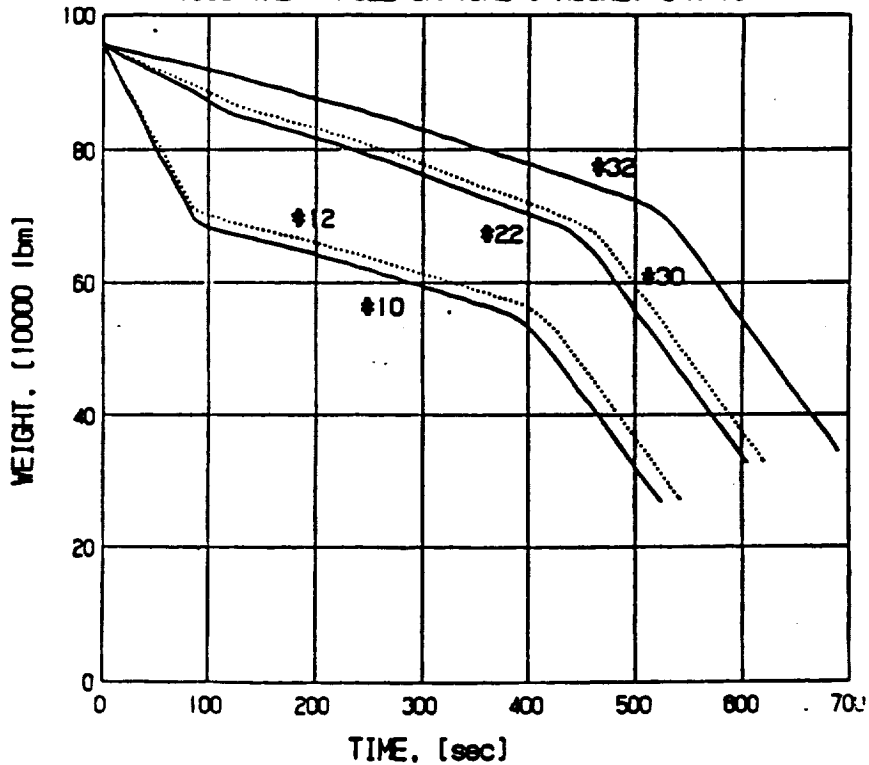

Vehicle Weight History for all Five RBCC Engine Types Studied

1995 TAD PAYLOAD vs. % INCREASE OF VEHICLE
EMPTY WEIGHT WITHOUT PAYLOAD FROM BASELINE WEIGHT
ESTIMATE - FULL CAPTURE & ROCKET @ M=15 - VTOHL

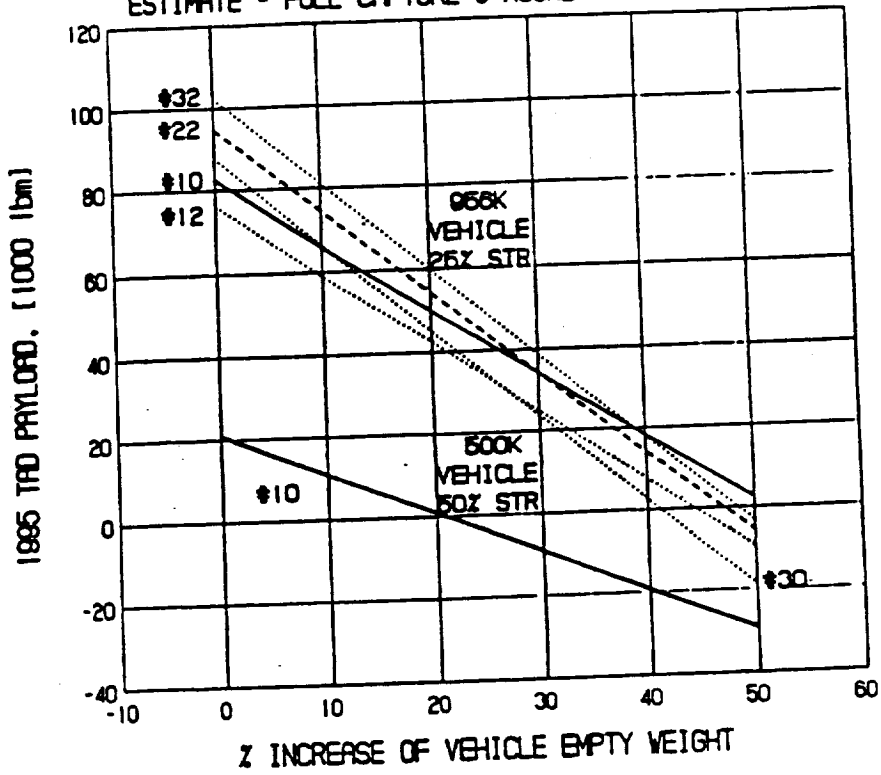

Payload vs. % Variation in Weight Estimates

IX & PAYLOAD vs. ENGINE TYPE
958K VEHICLE - 25% STRAKES - VTOHL
1995 TAD - FULL CAPTURE & ROCKET @ M=15

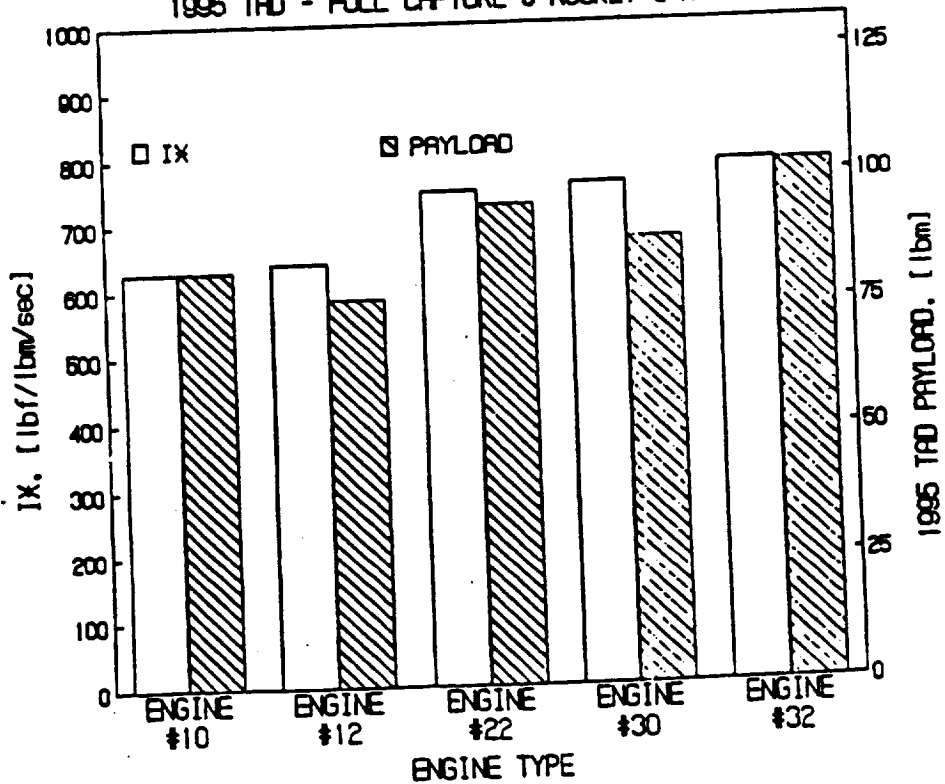

I* and Payload vs. Engine Types

1995 TAD PAYLOAD
 FULL CAPTURE & ROCKET @ M=15
 25% STRAKES - VTOHL

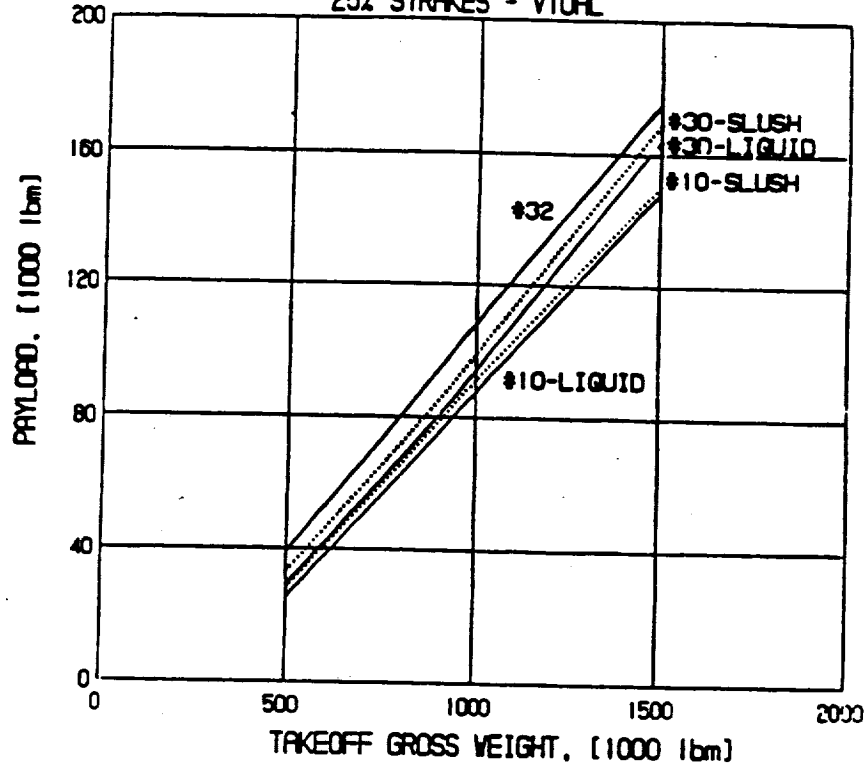

Payload vs. TOGW and Engine Type

1995 TAD PAYLOADS vs. FULL CAPTURE
 & ROCKET OUT MACH NUMBER
 500K VEHICLE - 25% STRAKES - VTOHL

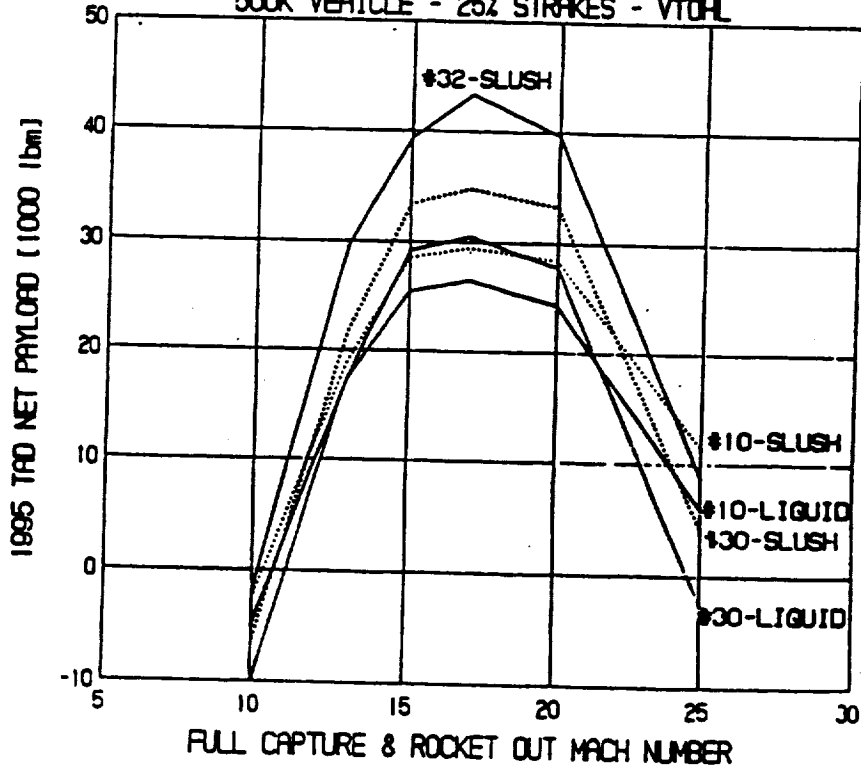

Payload vs. Full Capture Mach Number for Engines #10, #30 and #32

ANGLE OF ATTACK vs. MACH NUMBER
 1995 TAD - FULL CAPTURE & ROCKET @ M=15
 500K VEHICLE - #10 - VTOHL

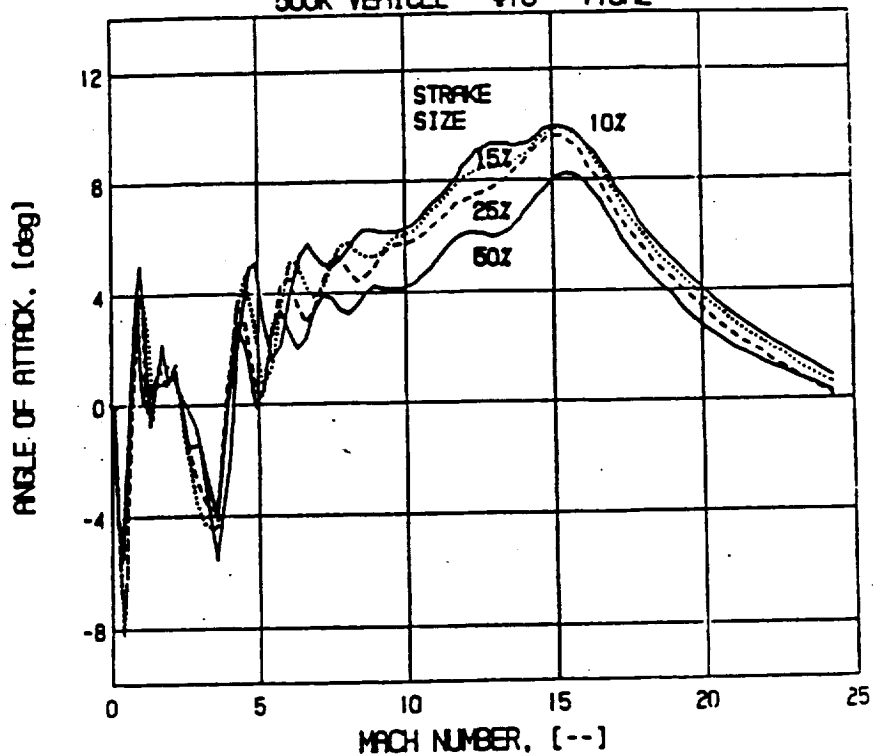

Angle of Attack vs. Mach Number for Varying Strake Sizes

1995 TAD PAYLOADS vs. STRAKE SIZE
 FULL CAPTURE & ROCKET @ M=15
 500K VEHICLE - #10 - VTOHL

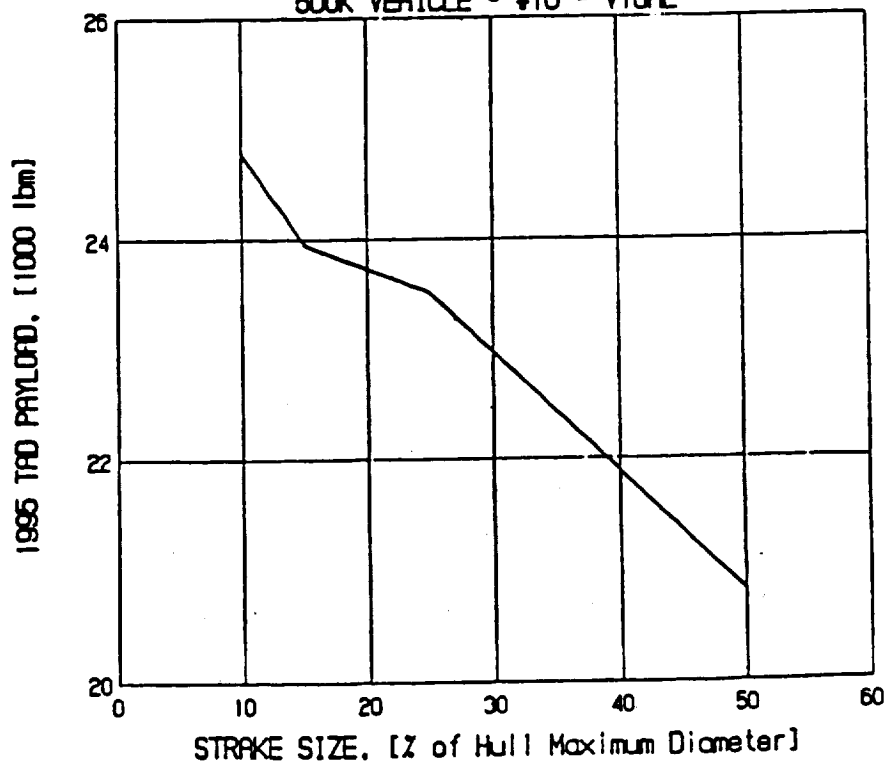

Payload vs. Strake Size for the Baseline Vehicle

1995 TAD PAYLOADS vs. +/- 10% Isp BY OPERATING MODE
 500K VEHICLE - #10 - 50% STRAKES - VTOHL
 FULL CAPTURE & ROCKET @ M=15

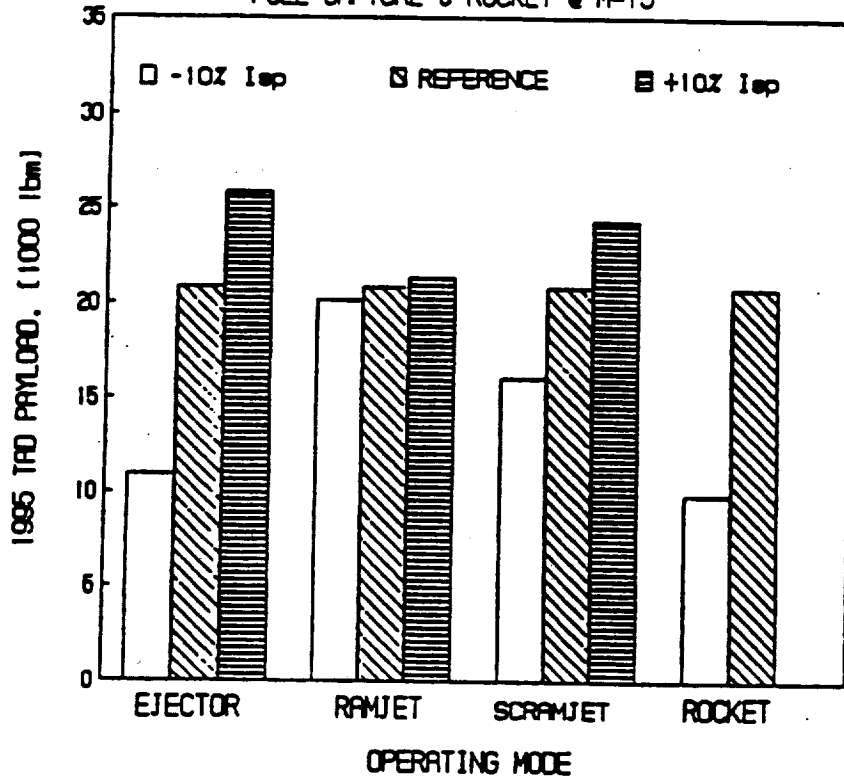

Effect of +/- 10% Isp Variation on Payload for the Baseline Vehicle

1995 TAD PAYLOAD vs. PERCENT CHANGE IN DRAG
 500K VEHICLE - #10 - 50% STRAKES - VTOHL
 FULL CAPTURE & ROCKET @ M=15

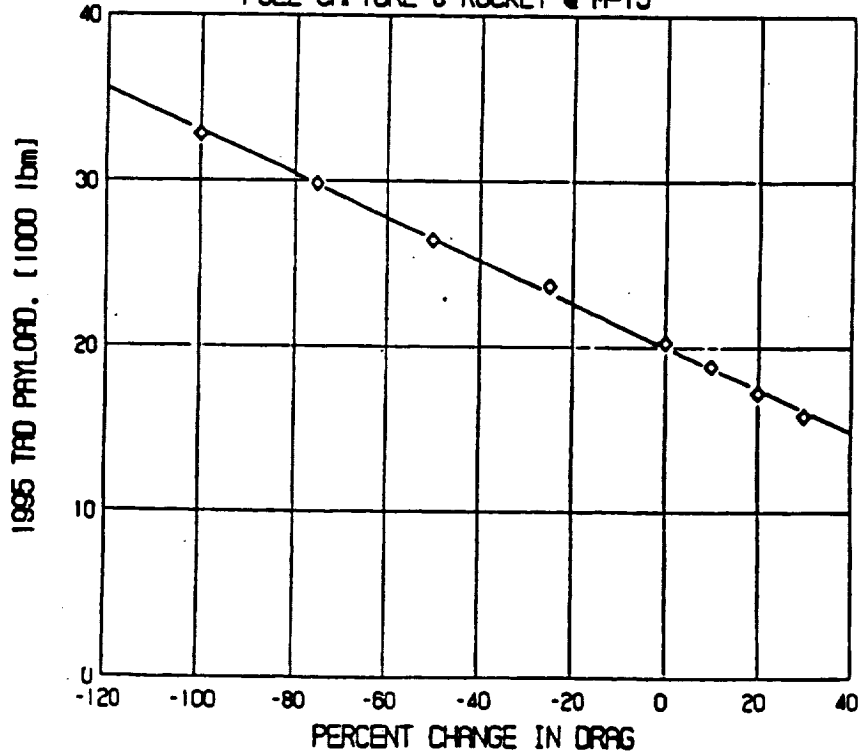

Payload vs. % Change in Drag Estimates for the Baseline Vehicle

ENDURANCE vs. CRUISE MACH NUMBER - 500K VEHICLE
 FULL CAPTURE & ROCKET @ M=15 - 25% STRAKES - VTO
 1995 TAD - (WITHOUT ORBITAL LOX)

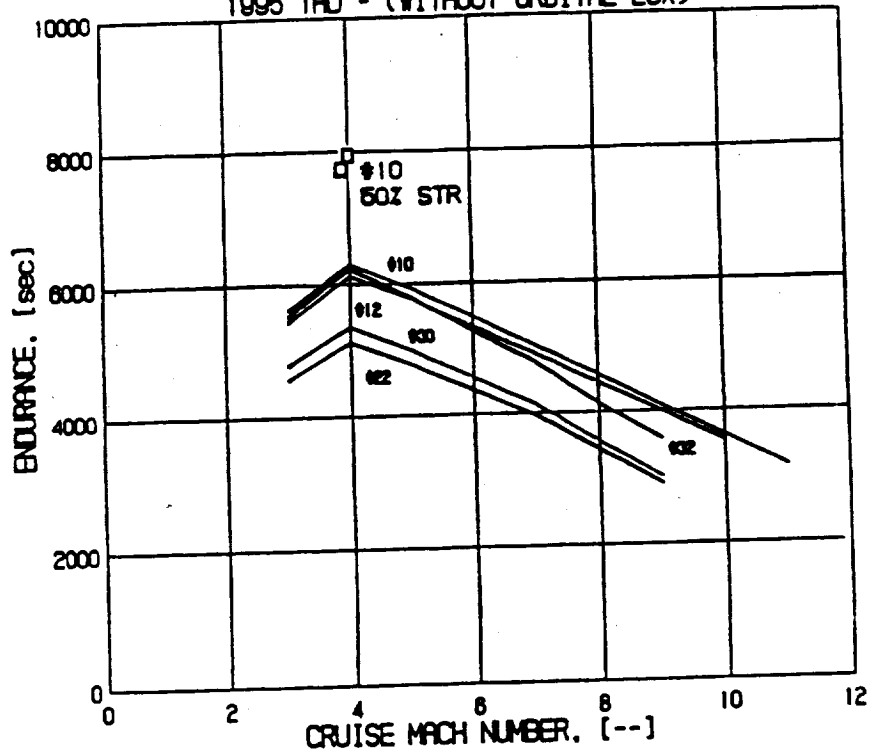

Baseline Vehicle Endurance vs. Cruise Mach Number

RANGE vs. CRUISE MACH NUMBER - 500K VEHICLE
 FULL CAPTURE & ROCKET @ M=15 - 25% STRAKES - VTO
 1995 TAD - (WITHOUT ORBITAL LOX)

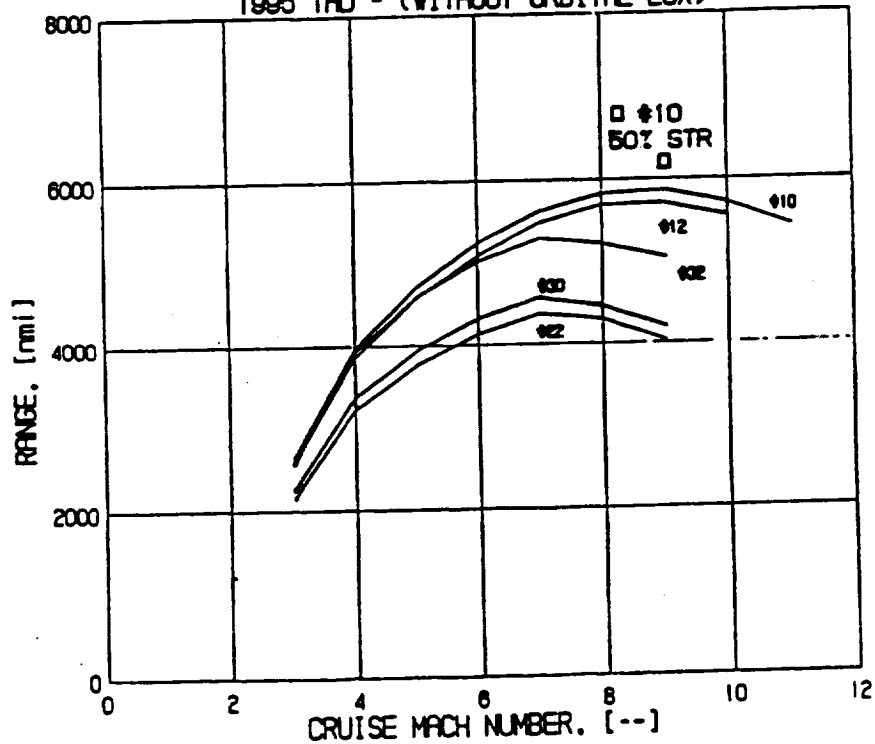

Baseline Vehicle Range vs. Cruise Mach Number

CONCLUSIONS - EJECTOR SCRAMJET ENGINES AND AXISYMMETRIC CONSTRUCTION

1. Ejector Scramjet engines appear to provide adequate performance for space transportation missions.
2. The simplicity of the Ejector Scramjet engine, in comparison to other combined cycle propulsion systems should produce significant reliability advantages.
3. The axisymmetric configurations provides the lowest drag possible.
4. The axisymmetric configuration provides the highest structural efficiency, i.e., lowest inert weight.
5. The axisymmetric RBCC/SSTO vehicle design with 8 or more "modular" engines offers the lowest DDT&E and Production Phase costs when compared to non axisymmetric SSTO vehicles using fewer engines of larger thrust rating.



TASKS PROPOSED - FOR DISCUSSION

Task 1 - Thrust Vector Lift/Aerodynamic Lift Study

Task 2 - Upgrade Aerodynamics and Trajectory Analysis Findings

Task 3 - Forebody, Base Drag and Rocket Mode CFD Analysis

Task 4 - Vehicle, Propulsion and Ground Support Systems Design

Task 5 - Vertical Landing

Task 6 - Upgrade Life Cycle Costs Analysis

Task 7 - Space Transportation System Characterization and Cost Analysis





Comparison to a common set of orbital transportation system requirements is required using a common set of analysis tools and methodologies.

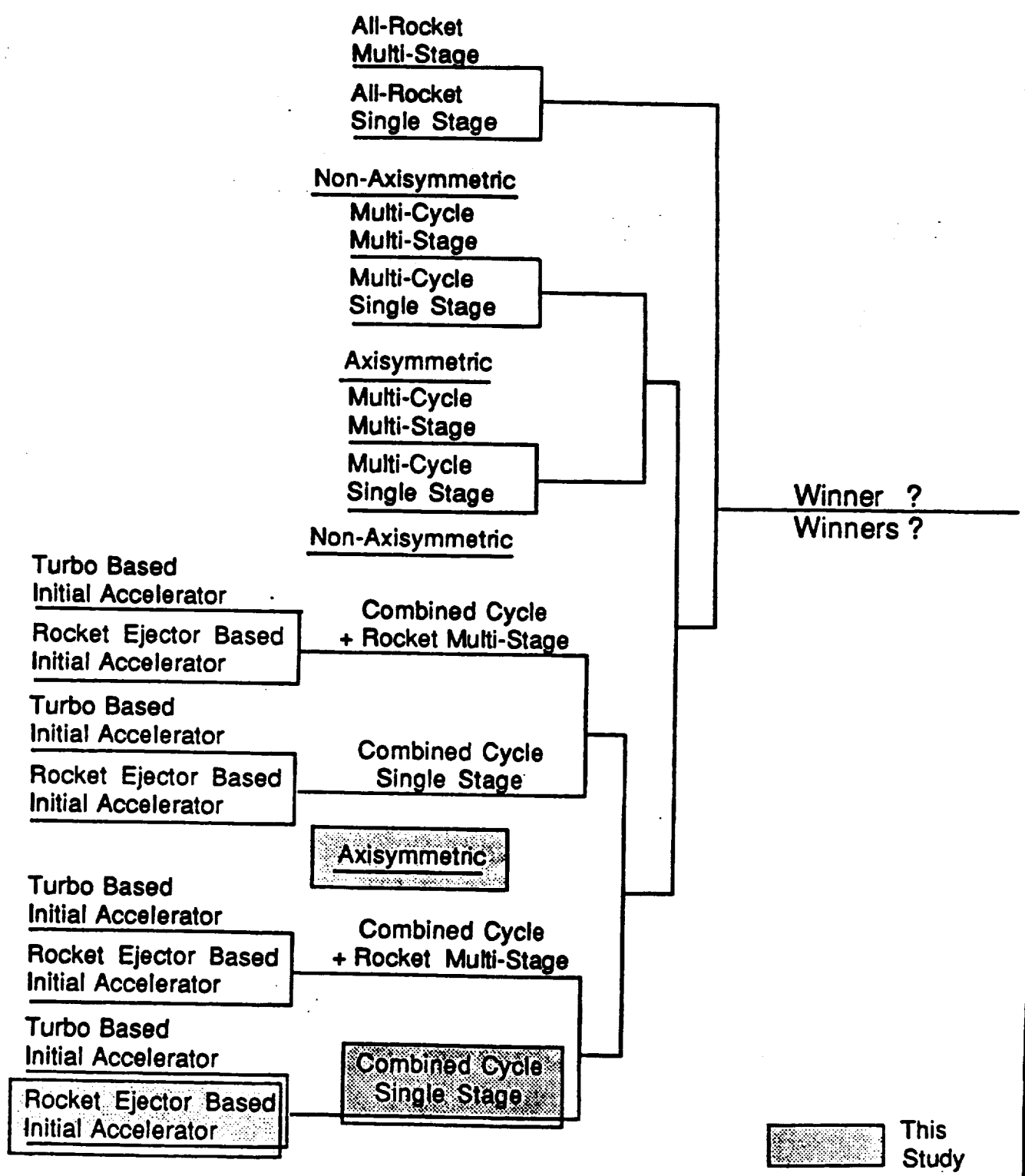

S3911TWF/BQ

REFERENCES

CURRENT REFERENCES

Foster, R.W., Escher, W.J.D., and Robinson, J.W., Air Augmented Rocket Propulsion Concepts, Final Report, USAF Astronautics Laboratory Report AFAL-TR-88-004, April 1988

Foster, R.W., Escher, W.J.D., and Robinson, J.R., Studies of an Extensively Axisymmetric Rocket Based Combined Cycle (RBCC) Engine Powered SSTO Vehicle, AIAA Paper 89-2294, AIAA/ASME/SAE/ASEE 25th Joint Propulsion Conference, Monterey, CA, July 1989

Foster, R.W., Optimization of the Rocket Mode Trajectory in a Rocket Based Combined Cycle (RBCC) Engine Powered SSTO Vehicle, AIAA Paper 89-2295, AIAA/ASME/SAE/ASEE 25th Joint Propulsion Conference, Monterey, CA, July 1989

AFAL STUDY REFERENCES

Dixon, S.C., NASA R&T for Aerospace Plane Vehicles, Langley Research Center, NASA Technical Memorandum 86429, May 1985.

Escher, W.J.D., and Flomes, B. J., et al, A Study of Composite Propulsion Systems for Advanced Launch Vehicle Applications, Final Report on NASA Contract NAS7-377, The Marquardt Corporation, Van Nuys, CA, April 1967

Anon, Pre-proposal Contractor Briefing Package, ALS System Contract #F04701-87-C-0101, USAF/AFSC, HQ Space Division, Los Angeles, CA, 5 May 1987

Simonson, A.J. and Schmeer, J.W., Static Thrust Augmentation of a Rocket Ejector System with a Heated Supersonic Primary Jet, Langley Research Center, NASA TND-1261, May 1962

Mossman, E.A., Rozycki, R.C., and Holle, G.F., A Summary of Research on a Nozzle-Ejector System, Martin Denver Research Report R-60-31, October 1960

Totten, J.K., Final Summary Technical Report on the Calendar Year 1963 Advanced Ramjet Technology Program, The Marquardt Company Final Technical Report under the Aeropropulsion Laboratory Contract AF 33(657)12146

Congelliere, J., Prevatte, N. and Lime, J., Advanced Ramjets Concepts, Vol II Ejector Scramjet Technology, The Marquardt Corporation, Report No. AFAPL-TR-67-118, May, 1968

Anon., Hypersonic Research Engine Project (Phase II), Final Oral Review Technical Presentation, Garrett AiResearch Report No. 75-1/338, NASA Contract NAS1-6666, 23 March 1975

Anon., Final Report - Hydrogen Turbofan Study, Garrett AiResearch Corporation for the Lockheed California Co. under NASA Langley Research Center Contract NAS-1-14614, NASA CR-145369, Vol. I, pp. 32-95, July 1978

Kumar, A., and Anderson, G. Y., Study of Hypersonic Inlet Flow Fields with a Three-Dimensional Navier-Stokes Code, AIAA Paper AIAA-86-1426, June 1986

Anon, YF-12 Experiments Symposium, NASA Conference Publication 2054, Dryden Research Center, September 1978

- Puerto, J. W., SERJ Fan Integration Study, Final Report, The Marquardt Corporation, Report No. 25279, AD500754, February 1969
- Hosack, G. A. and Stromsta, R. R., Performance of the Aerobell Extendible Nozzle, AIAA Journal of Spacecraft, Vol. 6, No. 12, pp 1416-1423, December 1969
- Congelliere, J., et al, 1965 Advanced Ramjet Concepts Program Final Report Vol. III - Ejector SCRAMJET Analysis, The Marquardt Corporation AFAPL-TR-66-49, August 1966
- Congelliere, J., Prevatte, N. and Lime, J., Advanced Ramjets Concepts, Vol II Ejector Scramjet Technology, The Marquardt Corporation, Report No. AFAPL-TR-67-118, May 1968
- Flornes, B. J., and Davidson, G. R., Advanced Ramjet Concepts, Vol VIII, RamLACE/SCRAMLACE Propulsion Systems Analysis and Design, Technical Report AFAPL-TR-67-188, Vol. VII, The Marquardt Corporation, Van Nuys, CA, February 1968
- Stull, F. D., Useful Scramjet Curves, a technical graph package obtained from the author, WPAPL, October 1984
- Anon, Alternate Vehicle/Propulsion Study, Boeing Military Airplane Company and Rockwell International Space Transportation Systems Division presentation package, Jun 1985
- Billig, F. S., and Beach, L. D., Hypersonic Propulsion, AIAA Sponsored Short Course Notes, Huntsville, AL, June 1985
- Escher, W. J. D., and Doughty, D. L., Assessment of Cryogenic Hydrogen-Induced Air Liquefaction Technologies, Final Report to Science Applications International Corporation under Subcontract No. 15-860020-82, September 1986
- Smith, L.R., Summary of Aerospace Program for 1963, The Marquardt, 1963 Annual Project Report under USAF Contract AF33(657)10796, Report No. APL-TDR-64-32, January 1964
- McCarty, R.D., Hord, J. and Roder, H. M., Selected Properties of Hydrogen (Engineering Design Data), National Bureau of Standards Monograph, National Engineering Laboratory, Boulder, CO, USGPO 1981
- Watson, K. A., DOF36 Program Users Guide, Air Force Wright Aeronautical Laboratories, Dayton, OH, April 1986
- Watson, K. A., Analysis Development - 6-DOF Trajectory Simulation, Air Force Wright Aeronautical Laboratory, Dayton, OH, 1986
- Freeman, Delma A., Advanced Space Transportation Studies Peer Review, NASA LaRC, 28 July 1987
- Hoerner, Sighard F., Fluid Dynamic Drag, Hoerner Fluid Dynamics, Brick Town, NJ., 1975
- Polhamus, Edward C., Predictions of Vortex-Lift Characteristics by a Leading Edge Suction Analogy, Journal of Aircraft, April 1971, Vol 8, No. 4, pp 193-199
- Bertin, John J. and Smith, Michael L., Aerodynamics for Engineers, Prentice Hall, Englewood Cliffs, N.J., 1979
- Lindenbaum, B., V/STOL Concepts and Developed Aircraft, Final Report, AFWAL-TR-86-3071, Air Force Wright Aeronautical Laboratories, November 1986

Anon. Special Short Course in V/STOL Aircraft, AGARD Report AGARD-R-710, North Atlantic Treaty Organization Advisory Group for Aerospace Research and Development, May 1984

REPORT DOCUMENTATION PAGE			<i>Form Approved</i> OMB No. 0704-0188	
Public reporting burden for this collection of information is estimated to average 1 hour per response, including the time for reviewing instructions, searching existing data sources, gathering and maintaining the data needed, and completing and reviewing the collection of information. Send comments regarding this burden estimate or any other aspect of this collection of information, including suggestions for reducing this burden, to Washington Headquarters Services, Directorate for Information Operations and Reports, 1215 Jefferson Davis Highway, Suite 1204, Arlington, VA 22202-4302, and to the Office of Management and Budget, Paperwork Reduction Project (0704-0188), Washington, DC 20503.				
1. AGENCY USE ONLY (Leave blank)	2. REPORT DATE 1992	3. REPORT TYPE AND DATES COVERED Conference Publication		
4. TITLE AND SUBTITLE Rocket-Based Combined-Cycle (RBCC) Propulsion Technology Workshop Tutorial Session			5. FUNDING NUMBERS WU-590-21-11	
6. AUTHOR(S)				
7. PERFORMING ORGANIZATION NAME(S) AND ADDRESS(ES) National Aeronautics and Space Administration Lewis Research Center Cleveland, Ohio 44135 - 3191			8. PERFORMING ORGANIZATION REPORT NUMBER E-6929	
9. SPONSORING/MONITORING AGENCY NAMES(S) AND ADDRESS(ES) National Aeronautics and Space Administration Washington, D.C. 20546-0001			10. SPONSORING/MONITORING AGENCY REPORT NUMBER NASA CP-10090	
11. SUPPLEMENTARY NOTES Responsible person, William Escher, (202) 453-2858.				
12a. DISTRIBUTION/AVAILABILITY STATEMENT Unclassified - Unlimited Subject Categories 15, 16, and 20			12b. DISTRIBUTION CODE	
13. ABSTRACT (Maximum 200 words) A Rocket-Based Combined-Cycle Propulsion Workshop is held at the University of Alabama in Huntsville under NASA Headquarters sponsorship. The goal of this workshop is to illuminate the Nation's space transportation and propulsion engineering community on the potential of hypersonic combined-cycle (airbreathing/rocket) propulsion systems for future space transportation applications. Appropriate background is provided at the workshop to participants and documented in this advanced conference proceedings. The Workshop's deliberative findings will be documented in subsequent proceedings.				
14. SUBJECT TERMS Rocket engine; Combined cycle; Propulsion; Transportation; Space			15. NUMBER OF PAGES 283	
			16. PRICE CODE A13	
17. SECURITY CLASSIFICATION OF REPORT Unclassified	18. SECURITY CLASSIFICATION OF THIS PAGE Unclassified	19. SECURITY CLASSIFICATION OF ABSTRACT Unclassified	20. LIMITATION OF ABSTRACT	